

TC-906-S-IP
 Rev A, Mar 2017
 www.commscope.com

Building distributor

Introduction

Suitable for FTTH applications where easily pre-connectorized splitters modules can be build in. The box is designed In such a way that it is suitable for both spliced and connectorized solutions of the riser cable.

Kit content



- Box
- Base tray
- Base tower
- Termination units
- Inserts for SMOUV and ANT

Accessories

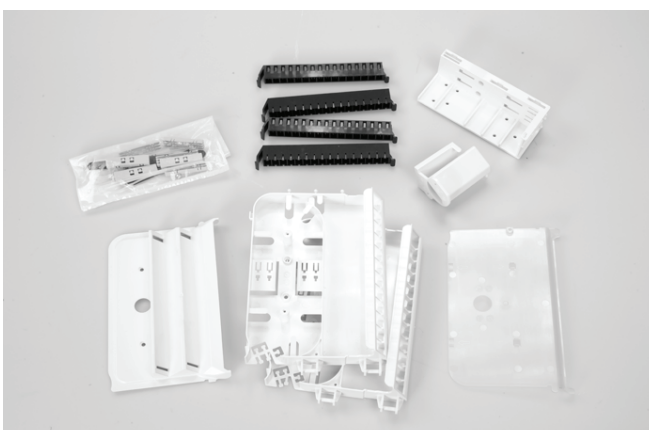

- Tray kit

Seals

Wrap around cable seals

Sealblock 4 x 10 mm

Cable diameter (mm)	Foam (± 5 mm)
3	95
4	90
5	80
6	75
7	70
8	60
9	50
10	40

Sealblock 4 x 15 mm

Cable diameter (mm)	Foam (± 5 mm)
9	125
10	115
11	105
12	95
13	85
14	70
15	60

Sealblock 2 x 20 mm

Cable diameter (mm)	Foam (± 5 mm)
14	155
15	140
16	125
17	110
18	95
19	85
20	75

Sealblock 24 x 8 mm

Cable range 1.8 – 7 mm

Sealblock rubber 1 x 18

To use in ports S4-S5 only
 Cable range 3 – 8 mm

Standard seals

- PG 16
- PG 21
- PG 29
- PG 29 (PTS 24)

1 Preparation of the box

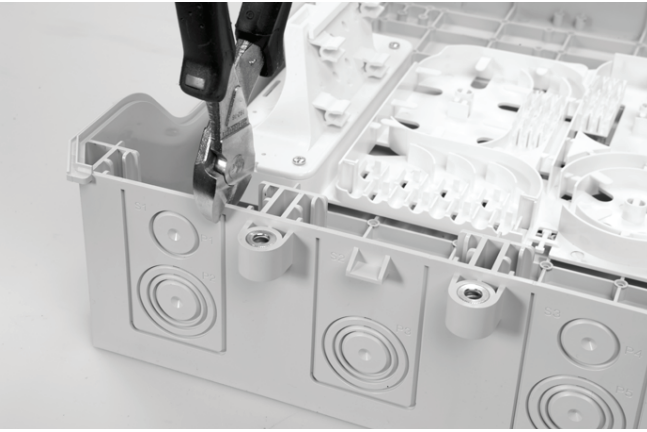

1.1 Make a cut on both sides of the port to open the port.

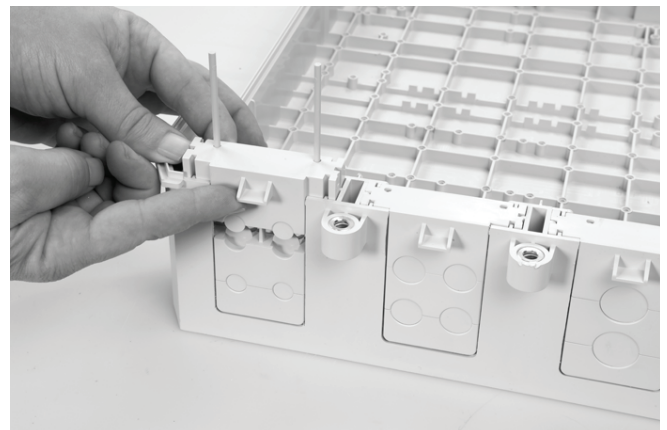
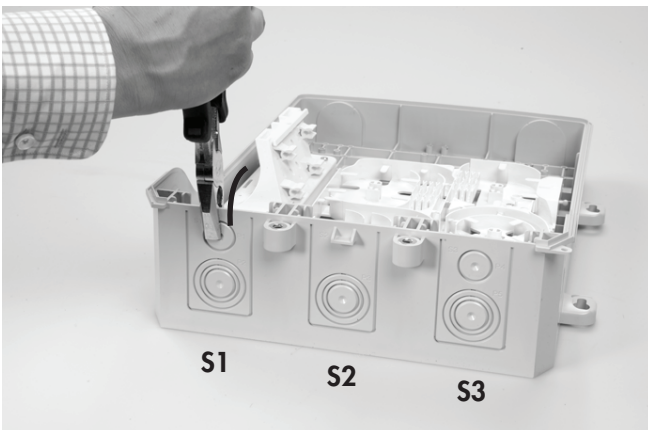
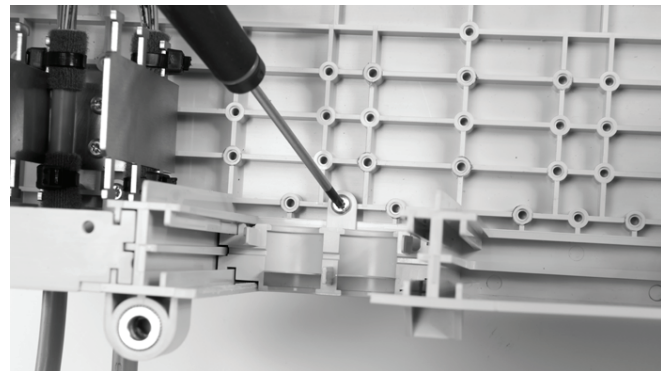

1.3 Different wrap-around ports are available (including brackets). Use two guiding pins to open the ports and to secure the bottom part to the box.

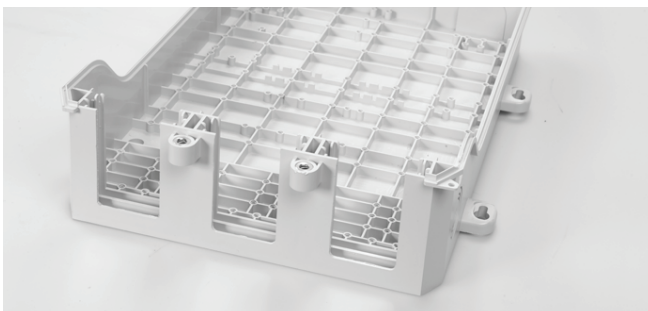

1.2 Use a plier to break-out the port, starting from front to back. Remove all the burrs.

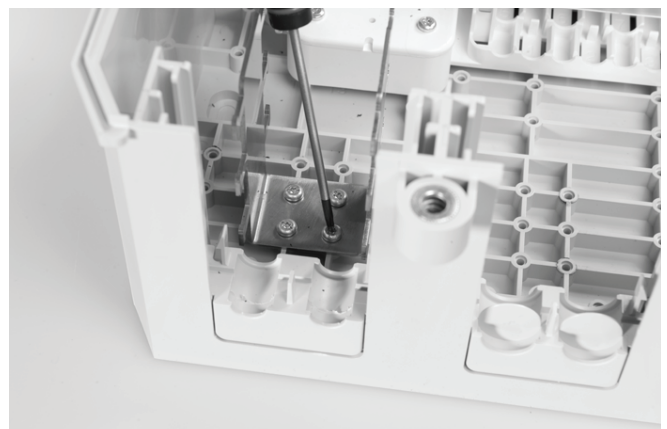

1.4 Install the cable bracket depending the cable seal.

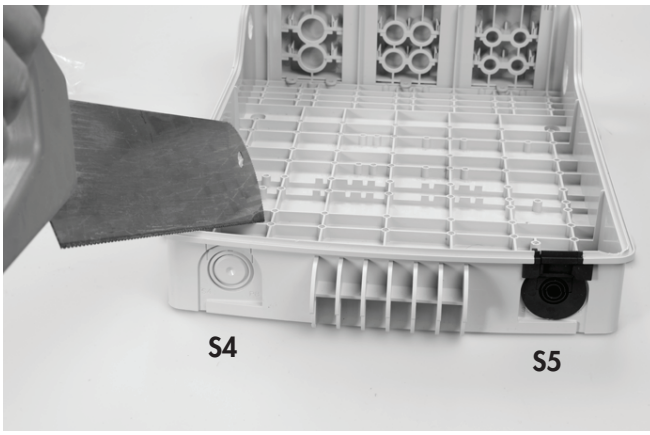

1.5 Use a hacksaw to reach the onion rings, which can be opened with a plier to open the in-line ports (S4/S5).

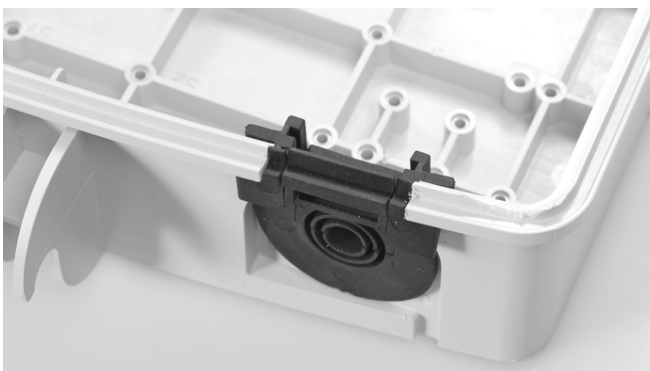

1.6 Install the wrap-around rubber seal into the port.

2 Base tray



2.1 Mark the loose tube at the position of the tray.

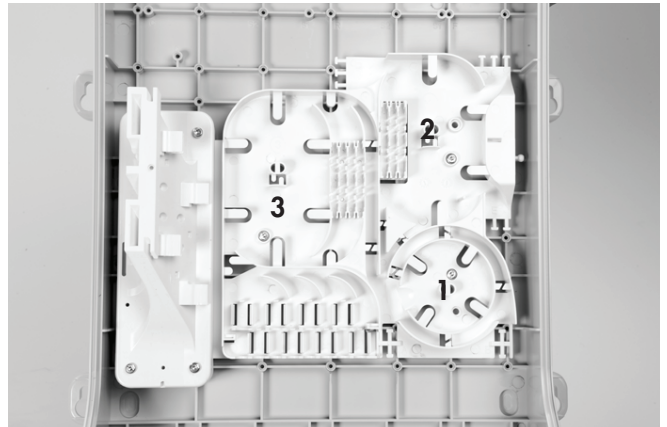

2.2 1: Storage area (dark fibers)
2: Splicing to splitter modules
3: Point to point applications



2.3 Route the fibers to the different areas (1-2-3).

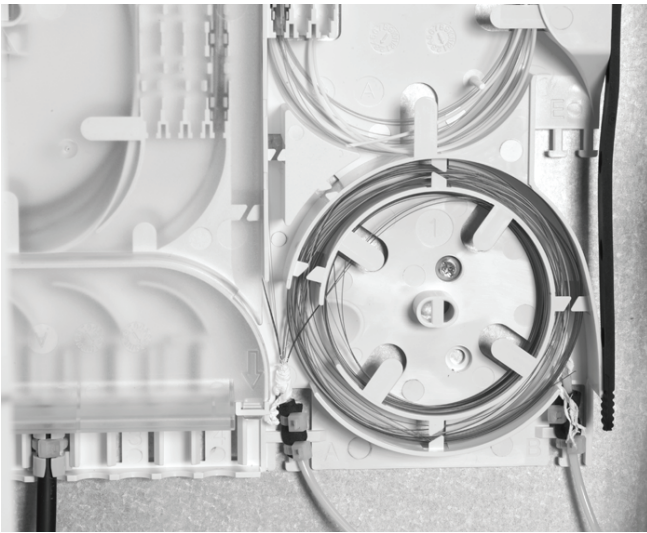

2.4 Store the fibers which will be used later.

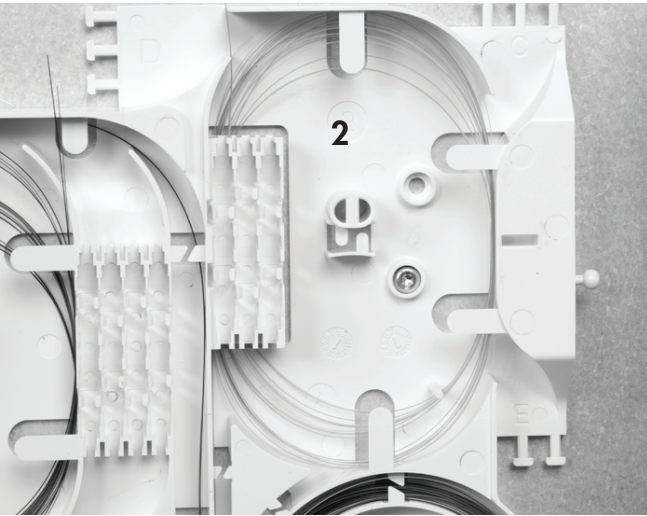

2.5 Store the fibers which will be spliced day 1 to the splitter modules.

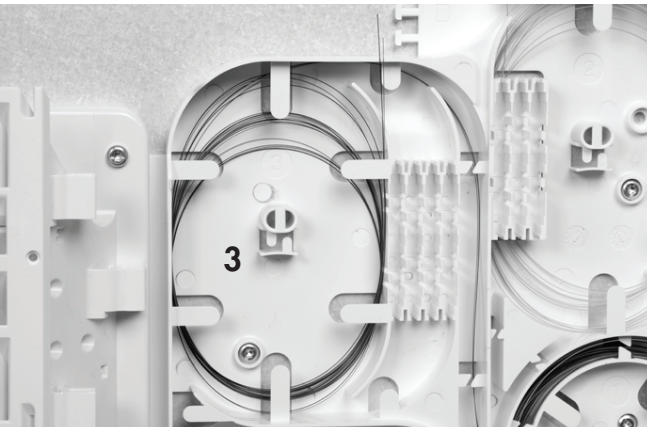

2.6 Store the fibers which will be spliced day 1 for the point-to-point applications.

3 Drop cables (point-to-point applications)

3.1 Remove the outer jacket over a distance of 1.2 m.

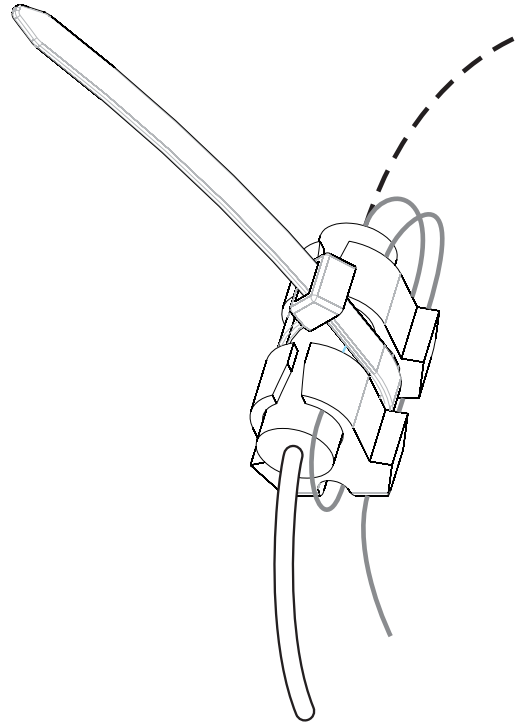

3.2 Wrap one layer of foam (20 mm) on the securing position if needed. Terminate the aramid strength member by securing the cable/pigtail onto the bracket with tie-wrap. Depending on the amount of aramid strength member, it needs to be wrapped twice around the bracket.

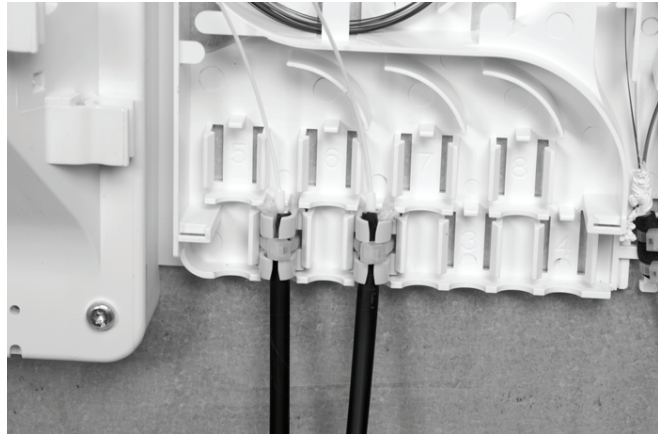

3.3 Install the terminated drop cable in the numbered ports on the base tray.

4 Patching tray

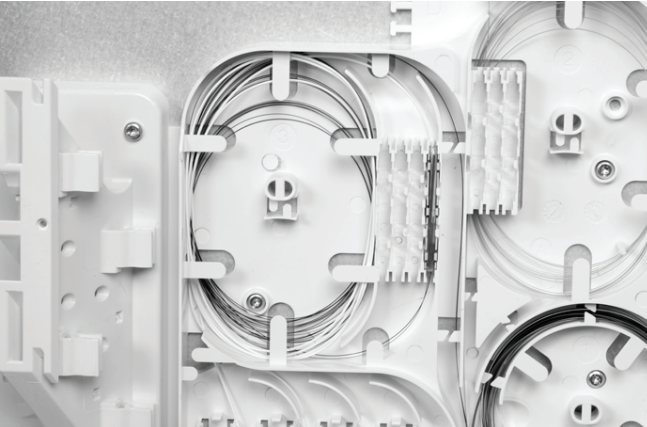

3.4 Splice the fibers from the drop cable to the fibers from the looped cable. In case of SMOUV, use the insert.

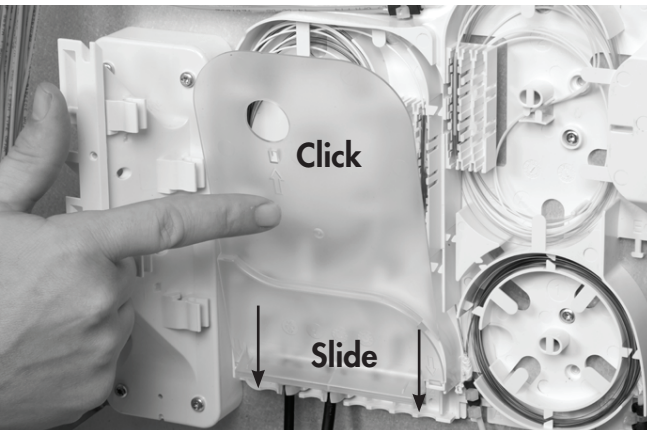

3.5 Install the cover onto the tray.

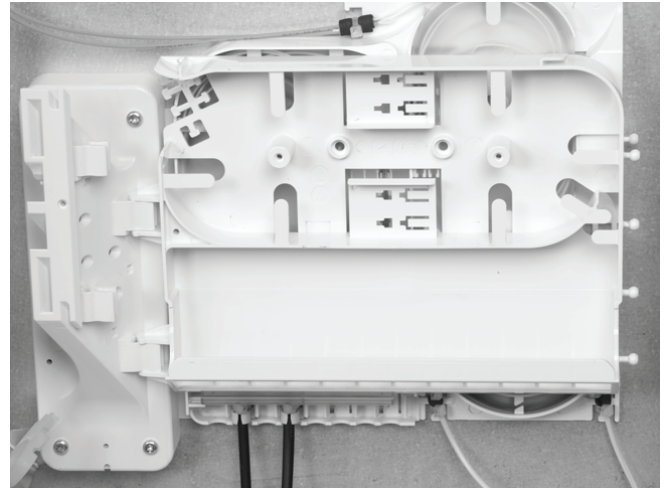
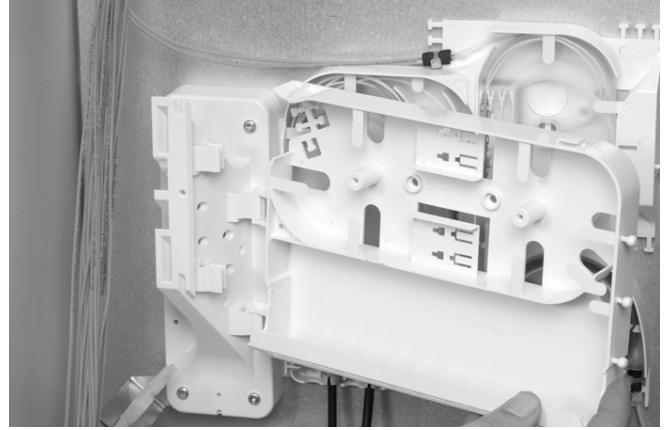

4.1 Install the patch tray onto the tower.

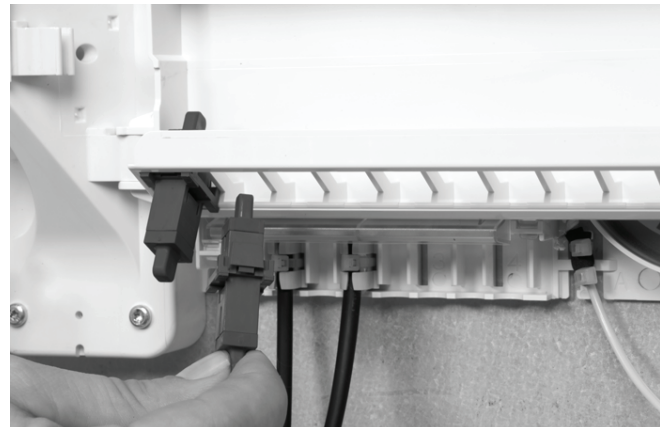

4.2 Insert the adaptor into the designated positions.

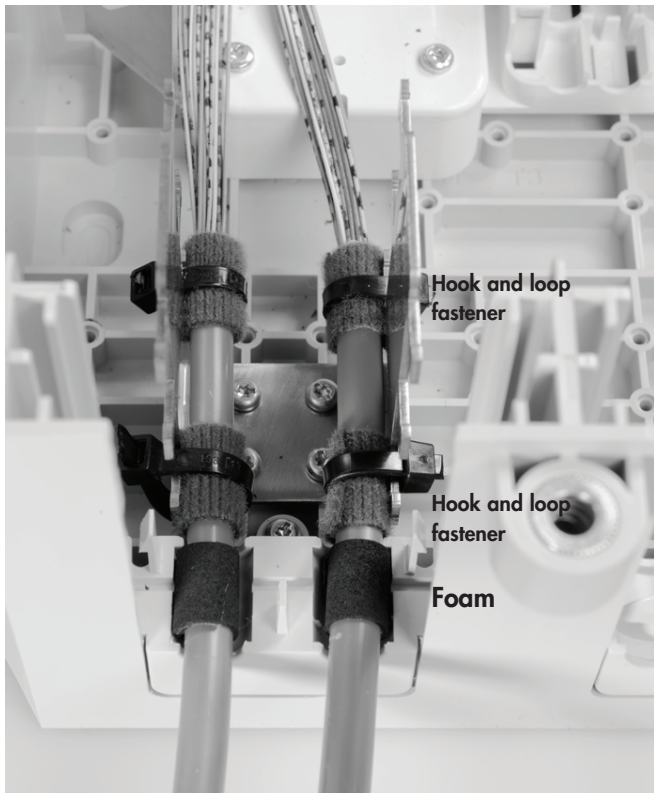

4.3 Install the cable into the port and secure with hook and loop fastener tape onto the bracket and seal with foam (see length page 1).

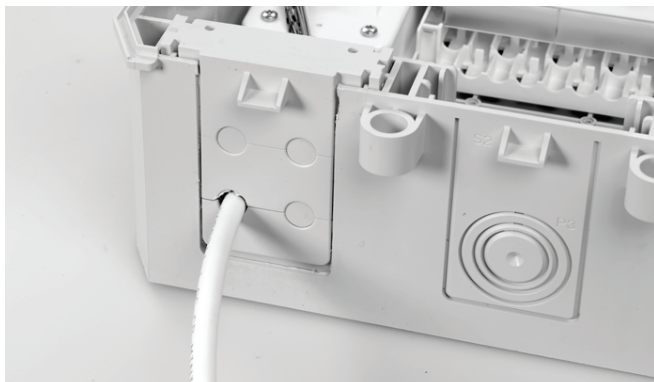

4.4 Close the port.

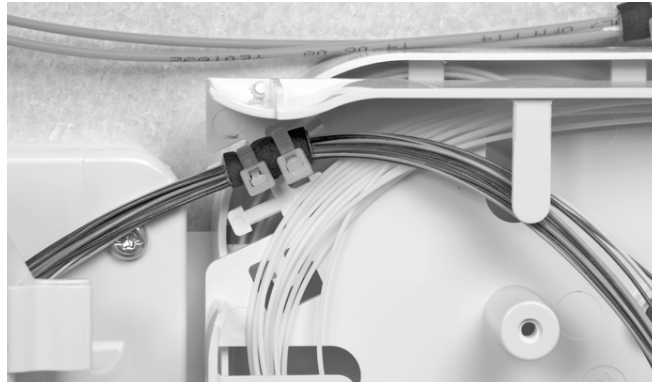

4.5 Install the foam at the position on the patch tray and secure with 2 tie-wraps as shown on the picture.

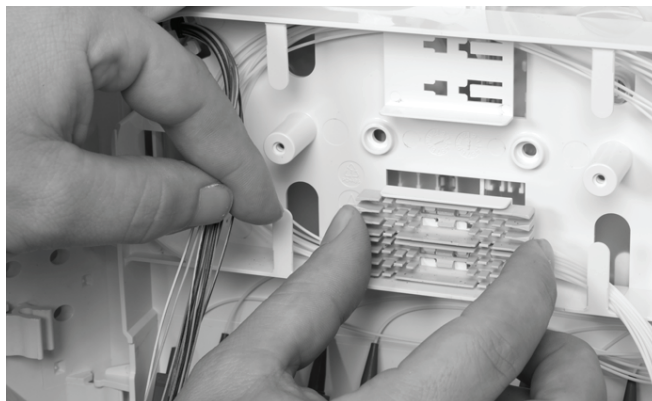

4.6 Install the splice holders onto the patch tray.

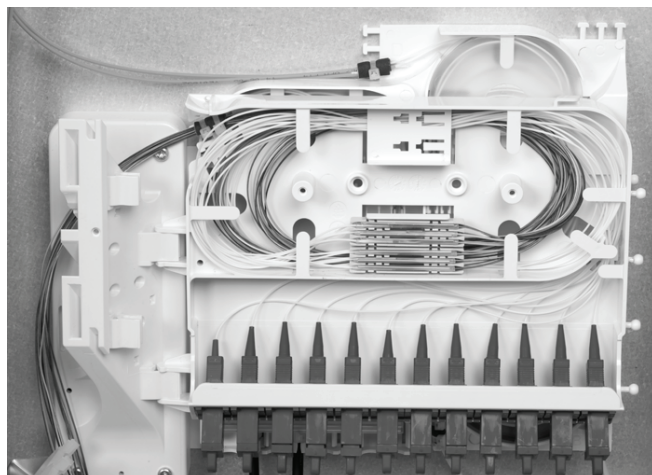

4.7 Splice the MINI PICO fibers to the pigtails and store the overlength in the splice area. Check the orientation of both fibers to avoid crossings.

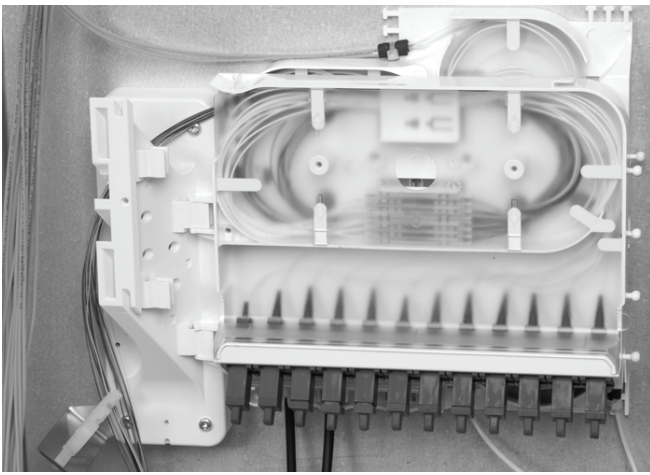

4.8 Install the cover onto the tray.

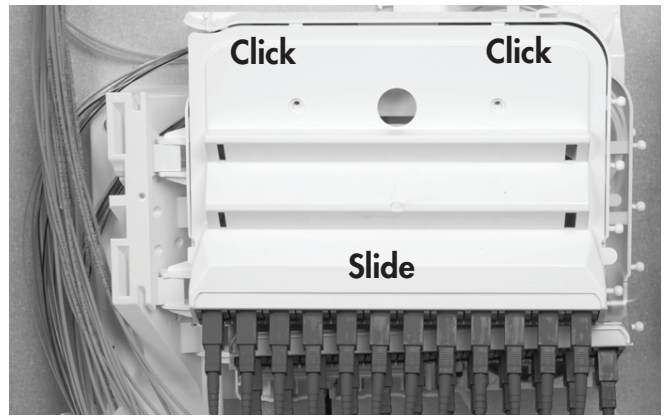

4.11 Install the cover onto the tray.

Mini PICO (pre-connectorized)

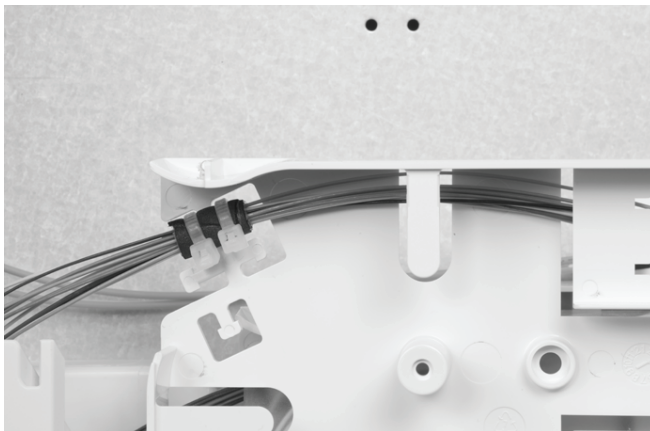

4.9 In case of pre-connectorized MINI PICO cable, fibers are also routed behind the tower and secured with foam and tie-wraps onto the tray.



4.12 Secure the patch trays with the rubber flex part, as shown.

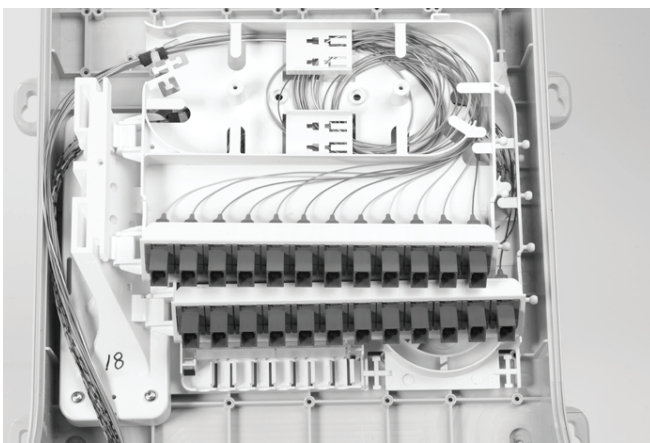

4.10 Connect the mini PICO cable with the designated adaptors and store the overlength in the splice area.

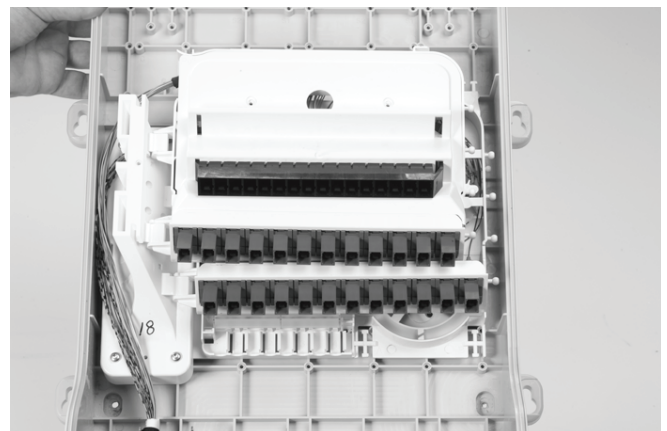

4.13 2 parking places for pigtails from splitter which are not used day 1 can be installed.

5 Splitters

OCM6 in-line

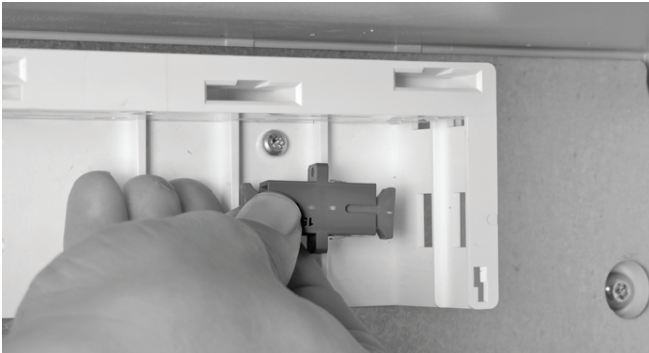

5.1 Install the adapter in the splitter holder.

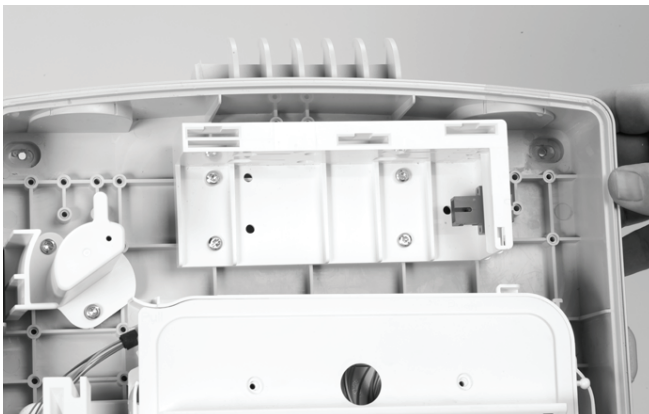

5.2 Install the bend control and splitter holder into the box.

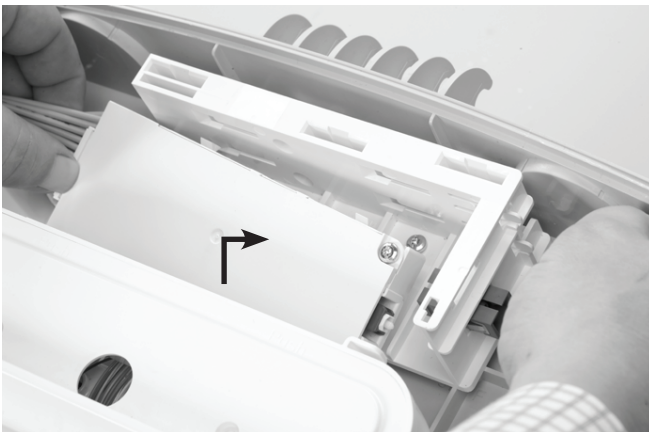

5.3 Install the splitter into the holder.

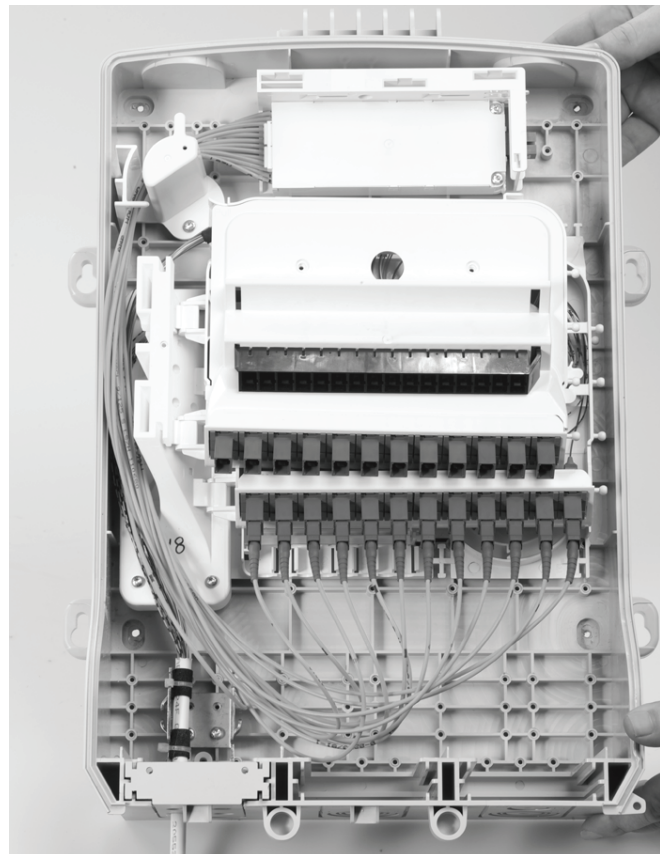

5.4 Route the pigtails to the designated adapters on the patch tray. Bundle the pigtails with hook and loop fastener when needed.



5.5 Install the incoming pigtail and route the fiber to the splicing to "splicing to splitter modules" for splicing. Remove the outer jacket over a distance of 1.2 m. Secure with foam and tie-wrap.

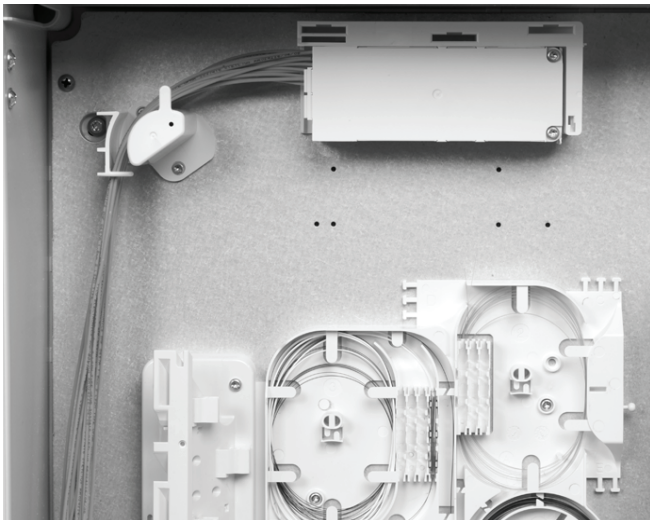
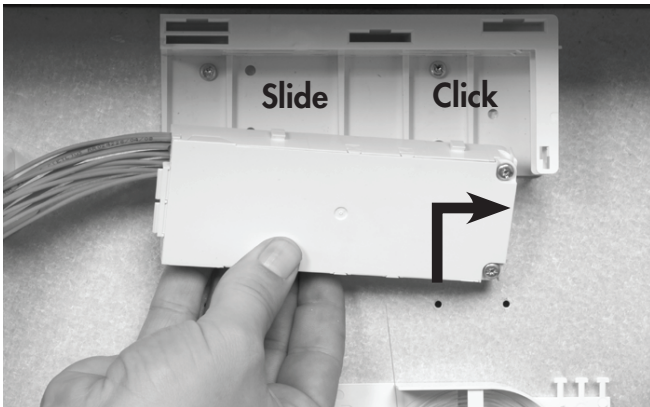

5.6 Install the splitter into the holder and route the pigtails via the bend control.

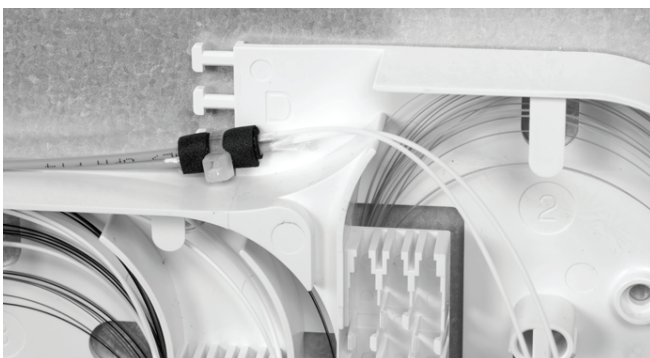
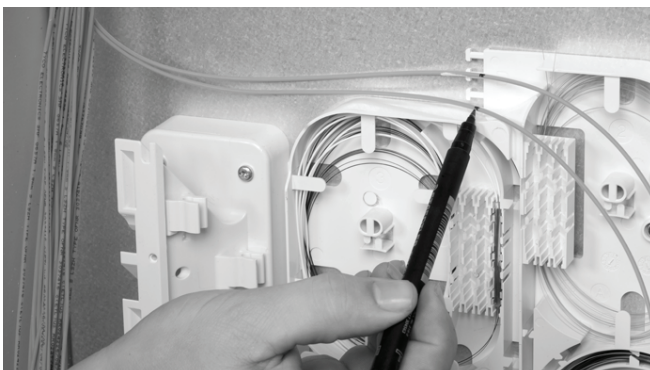

5.7 Route the incoming pigtails of the splitter (marked with red flag) to the base tray and remove the outer jacket from the mark over a distance of 1.2 m. Secure with foam and tie-wrap onto the base tray.

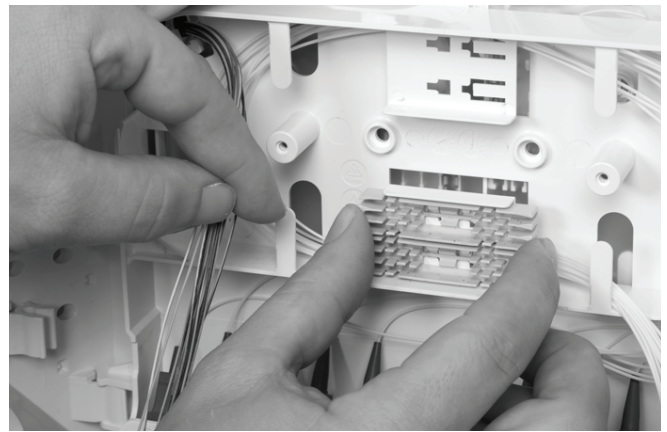

5.8 Install the splice holders onto the patch tray.

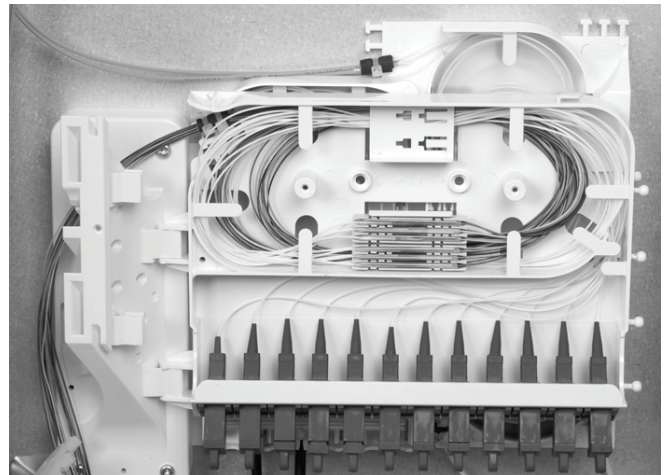

5.9 Splice the MINI PICO fibers to the pigtails and store the overlength in the splice area. Check the orientation of both fibers to avoid crossings.

6 Closing the box



6.1 Close the box.

To find out more about CommScope® products, visit us on the web at www.commscope.com

For technical assistance, customer service, or to report any missing/damaged parts, visit us at:
<http://www.commscope.com/SupportCenter>

© 2017 CommScope, Inc. All rights reserved.

SMOUV and all trademarks identified by ® or ™ are registered trademarks or trademarks, respectively, of CommScope, Inc.

This document is for planning purposes only and is not intended to modify or supplement any specifications or warranties relating to CommScope products or services.

This product is covered by one or more U.S. patents or their foreign equivalents. For patents, see:
www.commscope.com/ProductPatent/ProductPatent.aspx.