

1.0 General Product Information

Important: Read and follow all safety precautions and warnings documented in the appropriate closure installation instructions.

The FOSC A & B Closure ribbon splice tray is designed for use in CommScope® FOSC 400 A, FOSC 400 B, FOSC 450 A, FOSC 450 BS, FOSC 450 B and Air FOSC and FTerm AF closures and related products.

The trays are typically equipped with two splice modules attached to a stack module to accommodate 144 mass fusion fibers (12 fiber ribbon x 12 splices). To accommodate ribbon slack storage, A and B ribbon trays are twice the height of the standard CommScope fiber organizer trays, thereby occupying two standard tray positions in a closure.

2.0 Kit Contents

The kit contents may vary depending on version purchased.

- Splice tray with cover
- 2 splice modules and module holder
- Spiral tubing
- Ribbon holders
- Loose buffer tube wrap
- Tie wraps

3.0 Tray Ordering Information

3.1 Description Key

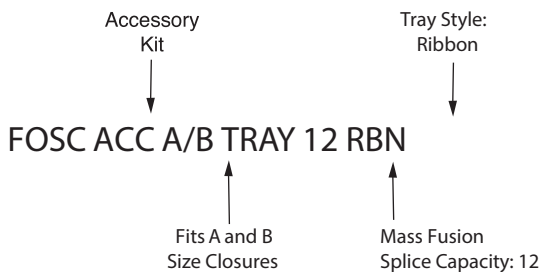

3.2 Tray Kit Information

Tray Kit	Quantity of Modules in Tray Kit	Type of Splice Module Included in Tray Kit	Splice Types Accommodated	Max. Qty. of Splices Accommodated per Tray
A Ribbon Tray Type				
FOSC-ACC-A/B-TRAY-12-RBN	2	SM-6 Modules	Mass Fusion	12
A Standard Type				
FOSC-ACC-A-TRAY-12	2	SM-6 Splice Modules	Single Fusion Single Mechanical Mass Fusion	12 12 12 ¹
FOSC-ACC-A-TRAY-16	2	SM-8 Splice Modules	Single Fusion Single Mechanical	8 8
FOSC-ACC-A-TRAY-24	2	SM-12 Splice Modules	Single Fusion	24 ²
B Ribbon Tray Type				
FOSC-ACC-A/B-TRAY-12-RBN	2	SM-6 Splice Modules	Mass Fusion	12
B Standard Type				
FOSC-ACC-B-TRAY-12	2	SM-6 Splice Modules	Single Fusion Single Mechanical Mass Fusion	12 12 12 ¹
FOSC-ACC-B-TRAY-16	2	SM-8 Splice Modules	Single Fusion Single Mechanical	8 8
FOSC-ACC-B-TRAY-24	2	SM-12 Splice Modules	Single Fusion	24 ²

1 Requires storage of ribbon slack in closure slack basket.

2 CommScope SMOUV splice sleeves are highly recommended in these applications.

4.0 Attach Ribbon to Tray

1. Prepare the main cable, strength member(s) and ribbon bundles in accordance with the procedures in the appropriate closure installation instructions for your application.
2. Install spiral or ribbon transportation tubing (in closure kit).
3. Install ribbon holder:
 - a. For 24-fiber ribbons, lay the ribbon bundle in the ribbon holder as shown in Figure 1A.

Note: Ribbons will need to be split into two 12-fiber ribbons.

- b. For 12-fiber ribbons, fold down the appropriate number of spacers as shown in Figure 1C. Use the following chart to determine the number of spacers to fold down:

Number of Ribbons	Number of Spacers
24	0
12	2
6 or less	3

- c. Stand the ribbons on end as shown in Figure 1B.
- d. Once the ribbons are in the ribbon holder, fold the top of the ribbon holder over and snap it closed.
- e. Slide the ribbon holder into the spiral tubing.

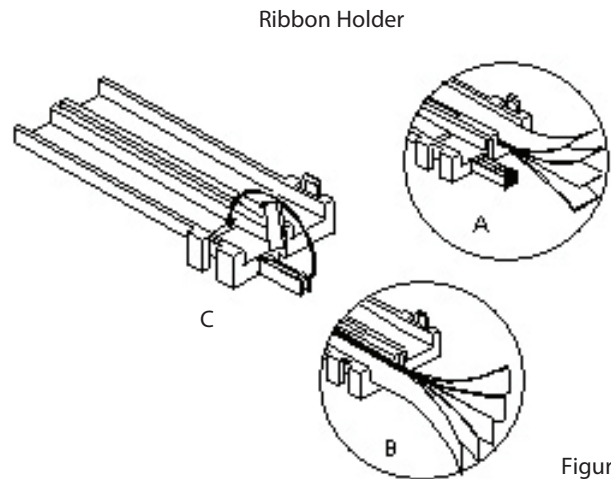

Figure 1

4. Secure prepared ribbon bundles to the splice tray with 1-1/2 wraps of loose buffer tube wrap and two tie wraps. (Figure 2)

If using ribbon transportation tubing, see Figure 3.

5.0 Ribbon Fiber Splicing Procedure

1. Measure the ribbon from the holes on the hinged end of the tray. Note: All feeder lengths will be 24" and distribution lengths will be 35" for butt configurations. The lengths for inline will always be 24" for feeder and distribution lengths. Refer to the diagram on pages 4 and 5 that matches your application. Page 4 shows butt splices, while page 5 shows inline splices.
2. Remove the splice holder from the tray.
3. If splicing 6 or less ribbons, remove the top splice module, splicing the ribbon starting from the inside ribbons onto the bottom splice module. Snap the top splice module back into the splice holder.

Note: If splicing 12 ribbons, fill the bottom splice module first then the top splice module.

4. Place a mark on the top splice module as shown in the diagrams. This will aid in positioning the splice holder on the tray.
5. Turn (slowly) the splice holder in the direction of the selected diagram (on page 4 or 5) that matches your application. The ribbons will form into loops. Place the splice holder in the center of the loops and snap the holder onto the tray.

Tip: A fiber pick will make installation easier. Be careful not to pinch the ribbons under the splice holder.

6. Arrange the fiber loops inside the tray. Secure all ribbons under the hold down tabs. If lengths are unequal or cut too long, extra slack may need to be pulled back into the storage area.
7. Snap the tray cover into place.

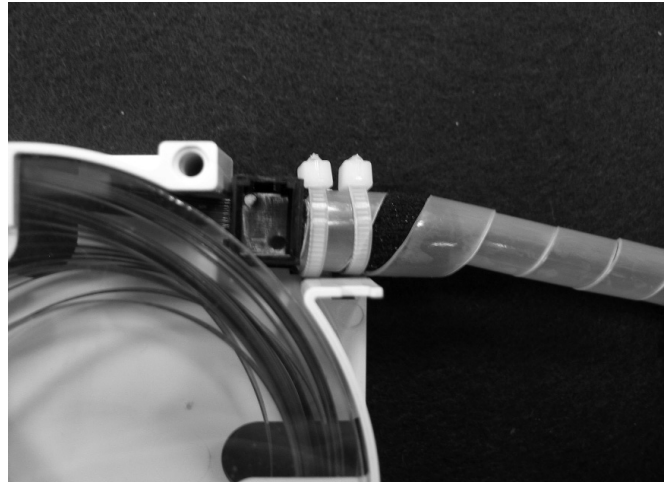

Figure 2

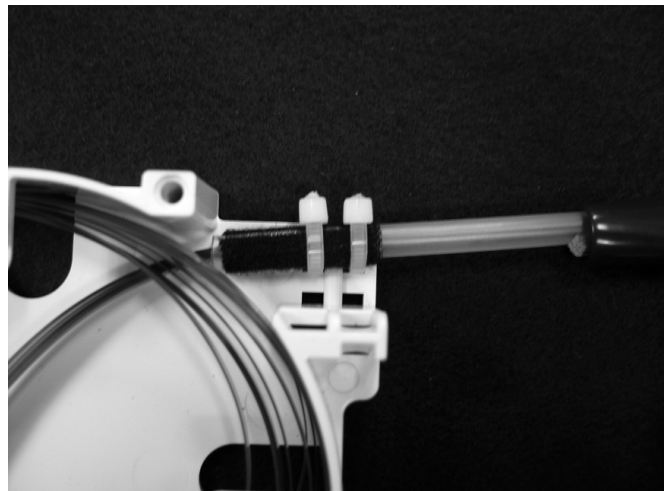
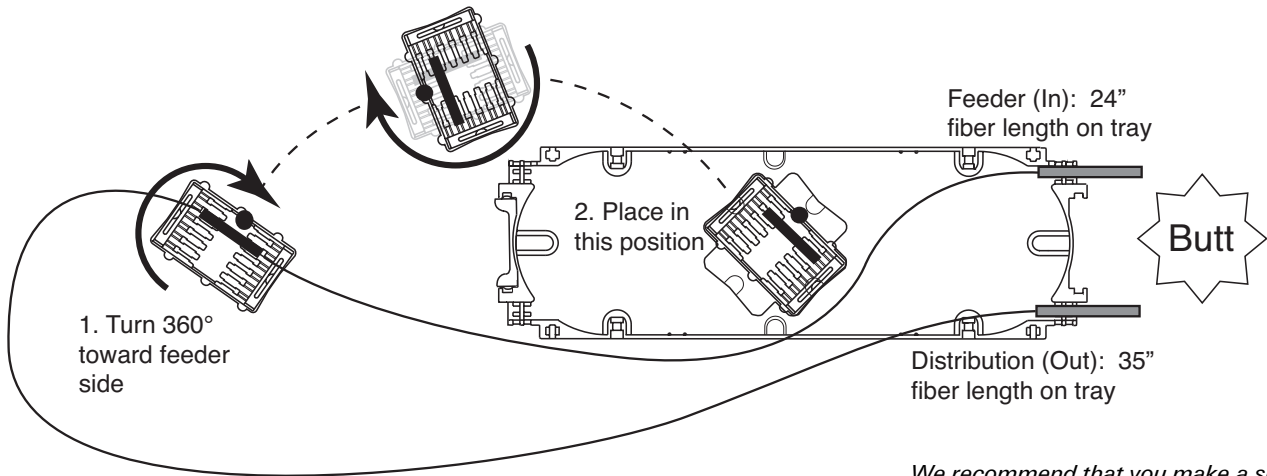
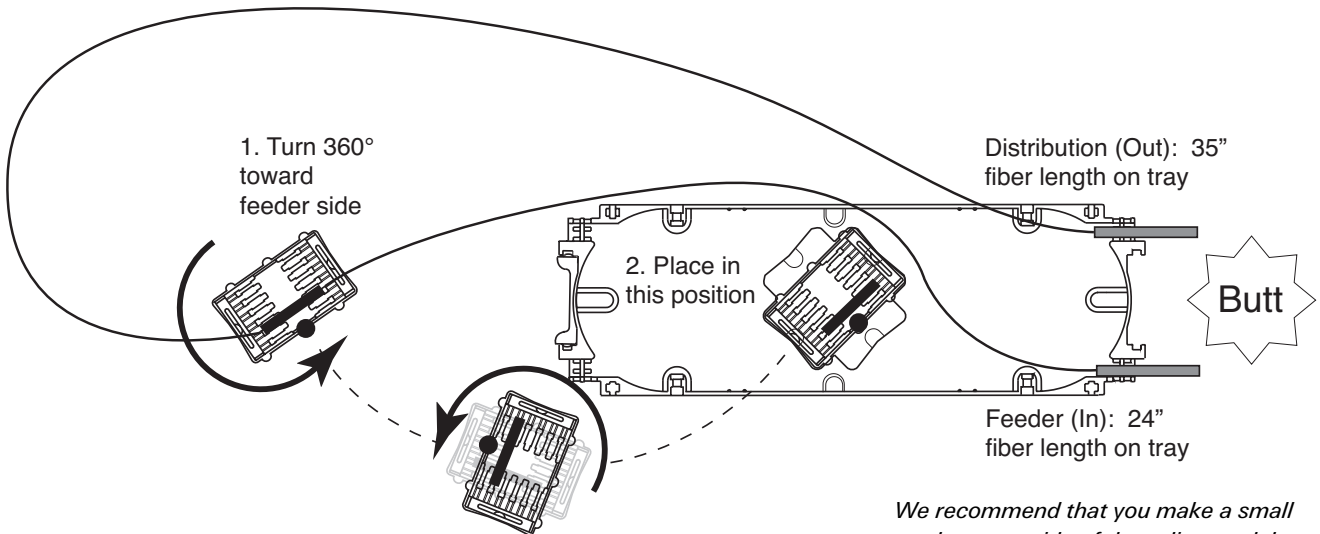
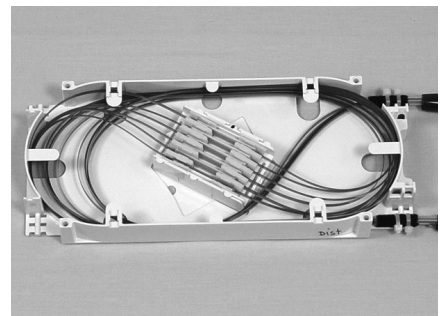
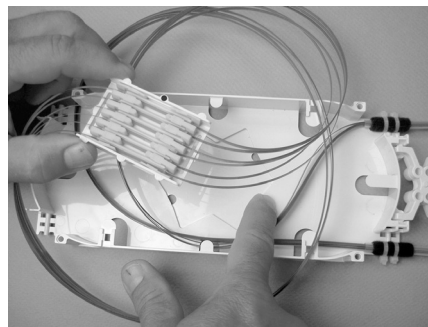
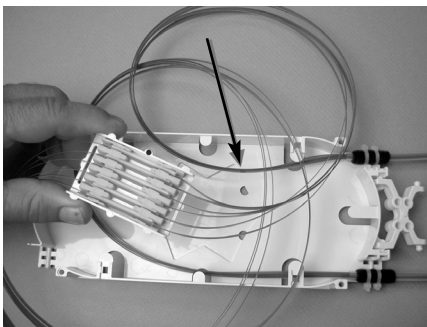

Figure 3



After rotating splice holder, reposition ribbon group as shown by arrow before snapping splice holder onto tray.

We recommend that you make a small mark on one side of the splice module so you can tell when you've turned the module 360°.



After rotating splice holder, reposition ribbon group as shown by arrow before snapping splice holder onto tray.

We recommend that you make a small mark on one side of the splice module so you can tell when you've turned the module 360°.

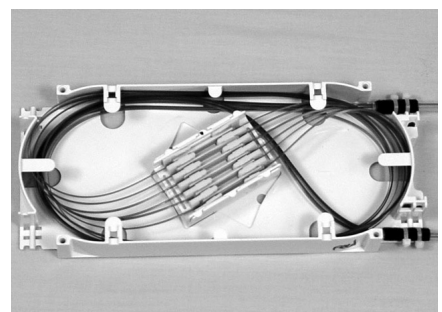
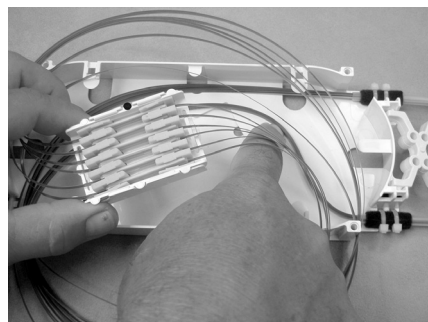
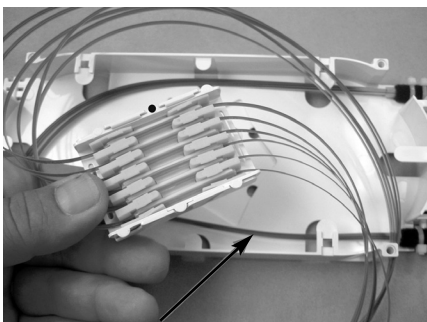

Feeder or Distribution: 24"

Feeder or Distribution: 24"

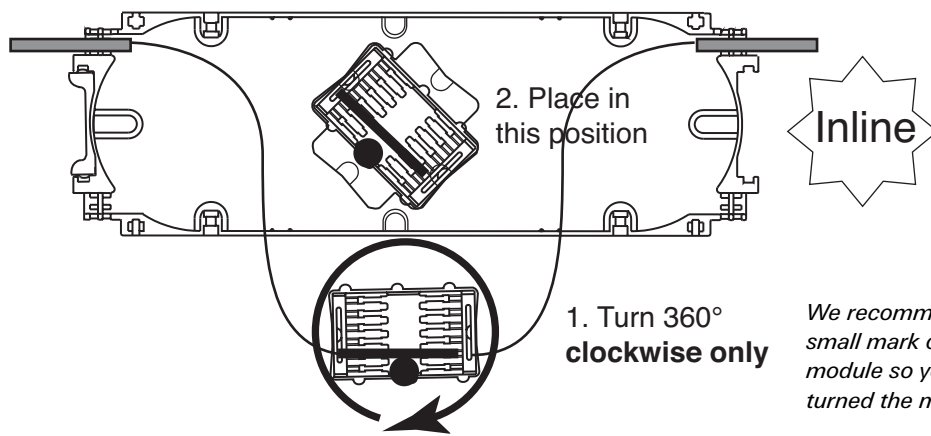

We recommend that you make a small mark on one side of the splice module so you can tell when you've turned the module 360°.

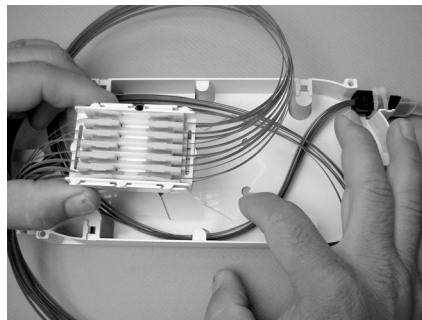
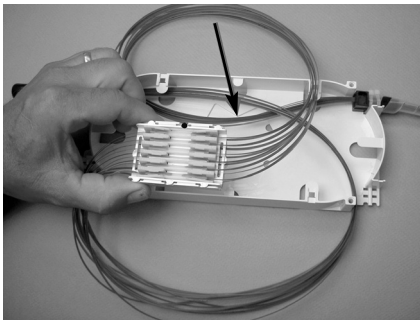

After rotating splice holder, reposition ribbon group as shown by arrow before snapping splice holder onto tray.

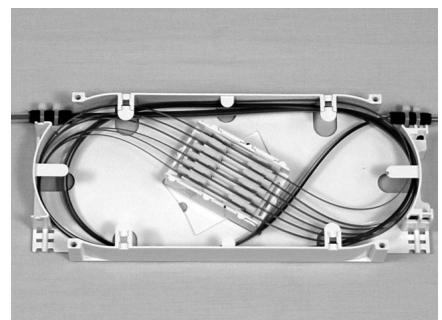
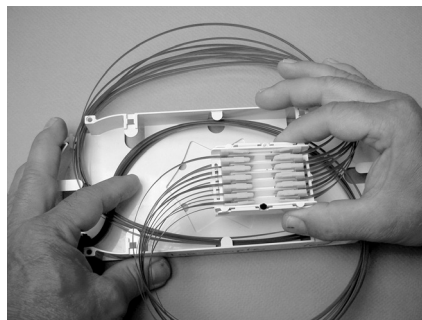
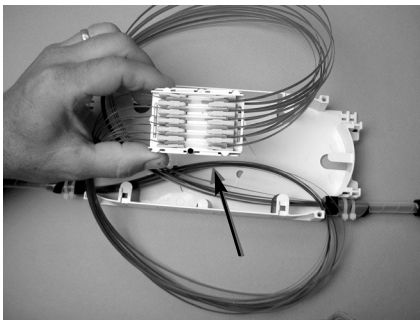

Feeder or Distribution: 24"

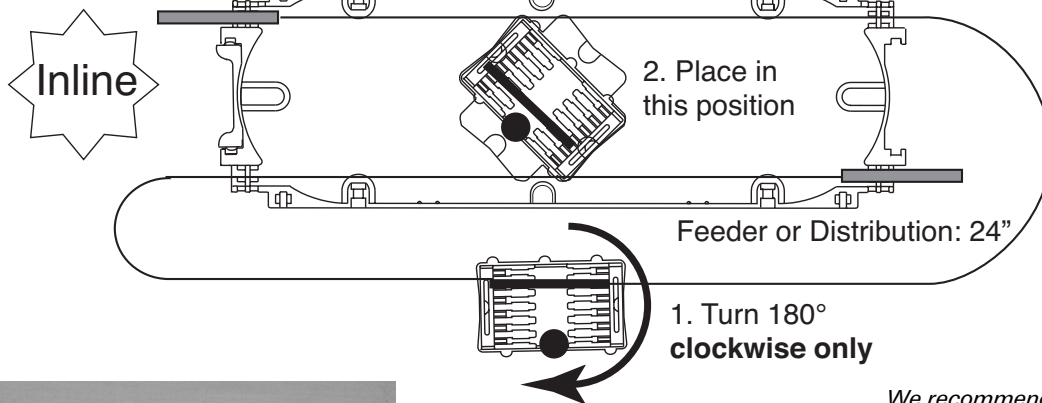

We recommend that you make a small mark on one side of the splice module so you can tell when you've turned the module 180°.

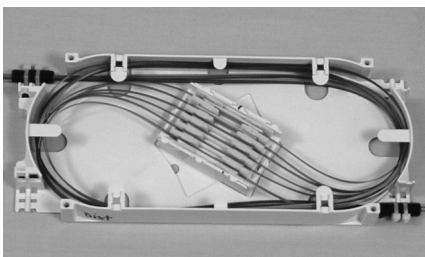

6.0 Additional Ordering Information

Splice modules and SMOUV splice protection sleeves are also available separately. See below for ordering information.

Splice Modules

Splice Module Kit	Quantity per package	Splice Types Accommodated	Splices per Module
FOSC-ACC-SM6-MODULES	48	Single Fusion Single Mechanical Single Mass	6
FOSC-ACC-SM8-MODULES	48	Single Fusion Single Mechanical	8
FOSC-ACC-SM12-MODULES	48	Single Fusion or NT-QPAK	12*

* Use of SMOUV splice protection sleeves is highly recommended in this application.

SMOUV Splice Protection Sleeves

SMOUV 1120 splice protector sleeves provide mechanical and environmental protection for fusion splices of single and ribbonized fiber.

The SMOUV 1120 sleeve consists of:

- clear outer heat-shrink material
- low temperature hot-melt adhesive to encapsulate the splice
- stainless steel rod for single fiber splices and a ceramic rod for ribbonized fiber splices to ensure proper alignment and rigidity.

SMOUV 1120 sleeves for single fibers are ideal for protecting single fusion splices of primary and secondary tight or semi-tight coated fibers.

SMOUV 1120 sleeves for multiple fibers are ideal for protecting mass fusion splices of ribbons with two to twelve fibers. All SMOUV 1120 sleeves are compatible with the full range of CommScope fiber management systems and organizers.

SMOUV Splice Sleeve Sizes and Specifications

Product Name	Fiber Type	Lengths (in millimeters)		
		Tubing	Adhesive	Rod
SMOUV 1120-01-US	Single	62	59	56
SMOUV 1120-02-US	Single	45	42	40
SMOUV 1120-03-US	Single	23	21	18
SMOUV 1120-R2/12-02-US	Ribbon	42	42	40

*Ceramic rod

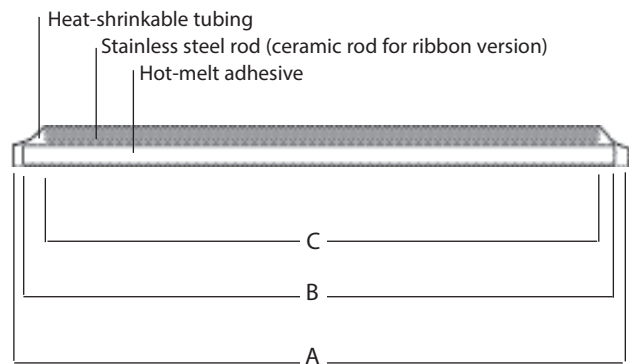

Technical Assistance Center (TAC)
Tel.: 800.830.5056
Email: TAC.Americas@commscope.com
www.commscope.com

FOSC 400, FOSC 450, AIR FOSC, FTerm, SMOUV, CommScope, and the CommScope logo are trademarks.

The information given herein, including drawings, illustrations and schematics which are intended for illustration purposes only, is believed to be reliable. However, CommScope makes no warranties as to its accuracy or completeness and disclaims any liability in connection with its use. CommScope's obligations shall only be as set forth in CommScope Standard Terms and Conditions of Sale for this product and in no case will CommScope be liable for any incidental, indirect or consequential damages arising out of the sale, resale, use or misuse of the product. Users of CommScope products should make their own evaluation to determine the suitability of each such product for the specific application.