

# Cable Technician

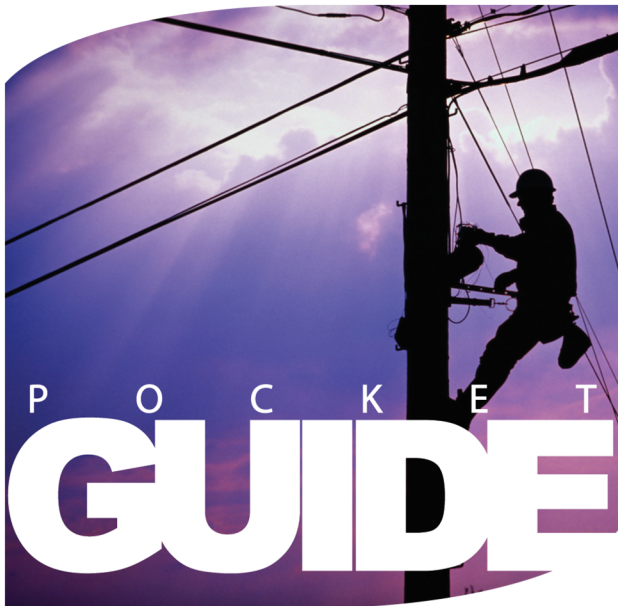

**RD-24**

**Subscriber Access Networks**

**SCTE • ISBE**

Society of Cable Telecommunications Engineers  
International Society of Broadband Experts

**COMMSCOPE®**



**CommScope**  
**Cable Technician Pocket Guide**  
**Subscriber Access Networks**

*Document MX0398*

*Revision U*

**COMMScope®**

## **Trademarks**

ARRIS, the ARRIS logo, CommScope, and the CommScope logo are trademarks of CommScope, Inc. and/or its affiliates. All other trademarks are the property of their respective owners. E-2000 is a trademark of Diamond S.A. CommScope is not sponsored, affiliated or endorsed by Diamond S.A.

No part of this content may be reproduced in any form or by any means or used to make any derivative work (such as translation, transformation, or adaptation) without written permission from CommScope, Inc and/or its affiliates ("CommScope"). CommScope reserves the right to revise or change this content from time to time without obligation on the part of CommScope to provide notification of such revision or change.

CommScope provides this content without warranty of any kind, implied or expressed, including, but not limited to, the implied warranties of merchantability and fitness for a particular purpose. CommScope may make improvements or changes in the products or services described in this content at any time. The capabilities, system requirements and/or compatibility with third-party products described herein are subject to change without notice.



# COMMSCOPE®

CommScope (NASDAQ: COMM) helps design, build and manage wired and wireless networks around the world. As a communications infrastructure leader, we shape the always-on networks of tomorrow. For more than 40 years, our global team of greater than 20,000 employees, innovators and technologists have empowered customers in all regions of the world to anticipate what's next and push the boundaries of what's possible.

Discover more at [www.commscope.com](http://www.commscope.com).

CommScope is a supporter of SCTE and its mission to provide broadband professionals with the best resources possible to help them on the job and in their careers.

CommScope is the proud sponsor of SCTE's "Star of Integrity" Award, recognizing excellence in the industry.

**SCTE** • **ISBE**

*Advancing the careers  
of telecommunications  
professionals and serving  
their industry through  
excellence in technological  
training, certification  
and standards.*

**800-542-5040**

**[www.scte.org](http://www.scte.org)**

## Contact Information

For Technical support contacts worldwide, please visit <https://www.commscope.com/Support>.

For a complete list of local sales representatives worldwide, please visit <https://extapps.commscope.com/howtobuy/sales-locator>.



## Introduction

This Pocket Guide is divided into 11 chapters. The right pages of each chapter are marked with a tab that lines up with the thumb index tabs on the right side of this page. You can quickly find the first page of each chapter by flipping through the pages of this Pocket Guide to find the chapter that you want or by using the Table of Contents which follows.

## Disclaimer

All information in this Pocket Guide is based on the latest industry and product information available at the time of printing.

CommScope, Inc. reserves the right to make changes at any time without notice. No part of this publication may be reproduced, stored in retrieval system, or transmitted, in any form by any means—electronic, mechanical, photocopying, or otherwise—without prior written consent of CommScope, Inc.

<b>Safety</b>	<b>1</b>
---------------	----------

<b>RF Data</b>	<b>2</b>
----------------	----------

<b>RF Calculations</b>	<b>3</b>
------------------------	----------

<b>Maintenance and Troubleshooting</b>	<b>4</b>
--	----------

<b>International TV Formats</b>	<b>5</b>
---------------------------------	----------

<b>Cable, Taps, Plug-ins, and Passives</b>	<b>6</b>
--	----------

<b>Fiber Data</b>	<b>7</b>
-------------------	----------

<b>Packet Transport (MPEG/IP)</b>	<b>8</b>
-----------------------------------	----------

<b>Symbols and Acronyms</b>	<b>9</b>
-----------------------------	----------

<b>Data Transmission</b>	<b>10</b>
--------------------------	-----------

<b>Miscellaneous Data</b>	<b>11</b>
---------------------------	-----------

# Table of Contents

---

<b>1 Safety</b>	
Utility Color Codes . . . . .	1-2
National Electric Code . . . . .	1-2
Housing Opening and Closing Examples for Nodes and Amplifiers . . . . .	1-3

---

<b>2 RF Data</b>	
Television Channel Frequency Data . . . . .	2-2
North America—CCIR System M . . . . .	2-6
Sub-VHF Frequencies . . . . .	2-10
Western Europe—Off-Air CCIR System B/G Frequencies . . . . .	2-11
Great Britain—CCIR System Frequencies . . . . .	2-11
Western CCIR System B/G Cable Frequencies . . . . .	2-12
China—CCIR System D . . . . .	2-14
CCIR Television Transmission Characteristics . . . . .	2-16
CommScope MC <sup>2</sup> Coaxial Cable . . . . .	2-17
Comm/Scope Drop Cable . . . . .	2-18
Tilt vs Cable Chart . . . . .	2-19
Cable and Equalizer Formulas . . . . .	2-20
HRC Channel Plan . . . . .	2-22
EIA Channel Nomenclature . . . . .	2-25
VHF and UHF Channel Plan . . . . .	2-26
QAM Channel Center Frequencies . . . . .	2-28
FCC Rules and Regulations, Part 76 . . . . .	2-29
Performance Standards . . . . .	2-35
MoCA Frequency Allocation . . . . .	2-36
WiFi RF Band Assignments (US) . . . . .	2-36
WiMAX RF Band Assignment (US Typical) . . . . .	2-36
Frequency Allocation Chart . . . . .	2-37

---

<b>3 RF Calculations</b>	
Determining Carrier Levels . . . . .	3-2
System Performance Equations . . . . .	3-7
Output Level on Performance . . . . .	3-20
CSO and CTB . . . . .	3-21
Derating Performance . . . . .	3-36
Voltage Addition Chart . . . . .	3-39
Power Addition Chart . . . . .	3-40
Spectrum Analyzer Error Correction Chart . . . . .	3-41
dBmV/Hz Bandwidth Conversion . . . . .	3-43
Return Loss, Reflection, and Standing Waves . . . . .	3-44

---

<b>4 Maintenance and Troubleshooting</b>	
Cumulative Leakage Index Calculation (CLI) . . . . .	4-2
Maximum Leakage Field Strength Levels . . . . .	4-3
Leakage Measurement at Different Distances . . . . .	4-4
Dipole Antenna Equations . . . . .	4-5
Sweep vs. Balance . . . . .	4-6

Troubleshooting . . . . .	4-11
<hr/>	
<b>5 International TV Formats</b>	
International Channel Standards . . . . .	5-2
Channel Formats . . . . .	5-5
Distortion Conversions for International TV. . . . .	5-7
Carrier Options. . . . .	5-8
<hr/>	
<b>6 Cable, Taps, Plug-ins, and Passives</b>	
Basic Cable Calculations . . . . .	6-2
Cable Specifications . . . . .	6-6
Plug-in Accessories . . . . .	6-14
RF Taps and Passives . . . . .	6-22
<hr/>	
<b>7 Fiber Data</b>	
Fiber Optic Color Code . . . . .	7-2
Fiber Loss . . . . .	7-2
Optical Connectors. . . . .	7-3
Optical Attenuators. . . . .	7-6
Optical Couplers and Splitters. . . . .	7-7
Fiber Care and Cleaning. . . . .	7-8
Wavelength Division Multiplexing Specifications. . . . .	7-16
Coarse Wavelength Division Multiplexing (CWDM) . . . . .	7-16
Dense Wavelength Division Multiplexing (DWDM). . . . .	7-17
Optical Modulation Index (OMI) . . . . .	7-30
dBm Conversions . . . . .	7-34
Test Point DC Voltage Reference . . . . .	7-35
<hr/>	
<b>8 Packet Transport (MPEG/IP)</b>	
SONET OC. . . . .	8-2
T1-E1 . . . . .	8-3
Cable Modems and eMTAs. . . . .	8-4
OSI Model . . . . .	8-4
Ethernet Frames . . . . .	8-6
Ethernet Bit Rates . . . . .	8-7
Ethernet Activation Testing . . . . .	8-8
MPEG PSI. . . . .	8-9
MPEG header. . . . .	8-10
IPv4 header . . . . .	8-11
IPv6 header . . . . .	8-13
TCP header . . . . .	8-14
UDP Header . . . . .	8-15
IPv4 Classes . . . . .	8-16
IPv4 Subnetting . . . . .	8-17
Decimal/Binary/Hexadecimal . . . . .	8-18
IPv6 Addressing . . . . .	8-19
IPv6 Multicast Addresses. . . . .	8-20
Fiber Colors . . . . .	8-21
IP Utilities. . . . .	8-22
T568(RJ-45) . . . . .	8-25

25 Pair Cable Color Codes (RJ-21) . . . . .	8-26
T568(RJ-11) . . . . .	8-27
RJ-31x . . . . .	8-28

---

## 9 Symbols and Acronyms

Common CATV Symbols . . . . .	9-2
Common Industry Abbreviations and Acronyms . . . . .	9-5

---

## 10 Data Transmission

Digital Transmission Standards . . . . .	10-2
Measuring Digital Carrier Signals . . . . .	10-3
DOCSIS Transmission Downstream . . . . .	10-5
EuroDOCSIS Transmission Downstream . . . . .	10-7
DOCSIS Transmission Upstream . . . . .	10-9
EuroDOCSIS Transmission Upstream . . . . .	10-10
Digital Signal Formats and Occupied Bandwidth <sup>1</sup> . . . . .	10-11
Bandwidth Correction Factors <sup>1</sup> . . . . .	10-12
RF Levels for 64 and 256 QAM Signals . . . . .	10-13
Addressing Schemes and Protocols . . . . .	10-14
Constellation Diagrams . . . . .	10-17
802.11a Channels . . . . .	10-19
802.11b/g Channels . . . . .	10-19
Linear Tilt Worksheet . . . . .	10-20
Digitizing an Analog Signal . . . . .	10-21
QAM Transmission Basics . . . . .	10-23
QAM Constellation Diagram Analysis . . . . .	10-25
BER, FEC, MER . . . . .	10-30
DOCSIS . . . . .	10-33
Common Industry Data Rates . . . . .	10-36

---

## 11 Miscellaneous Data

Scientific Prefix Symbols and Values . . . . .	11-2
Unit Abbreviations . . . . .	11-2
Unit Conversion Factors . . . . .	11-3
Cable Math . . . . .	11-4
Ohm's Law / Joule's Law Pie Chart . . . . .	11-6
Beat Table . . . . .	11-7
Signal-to-Interference Limits for Non-Coherent	
NTSC Carriers . . . . .	11-8
75 Ohm T- and Pi-Attenuators . . . . .	11-9
Wavelength and Antennas . . . . .	11-11
Signal Leaking Limits . . . . .	11-12
Field Intensity vs Dipole Level . . . . .	11-12
Directional Couplers . . . . .	11-13
dBmV Conversion (for 75Ω systems) . . . . .	11-14
Conversion Formulas . . . . .	11-17
Celsius/Fahrenheit Conversion . . . . .	11-18
Length Conversions . . . . .	11-19
Data Interface Connectors . . . . .	11-20





***CommScope, Inc.***

## 1.1 Utility Color Codes

Utility Color Codes are national standards used to identify existing underground utilities. The table below is based on “The American Public Works Association” recommendations and the ANSI Standard Z-53.1 for Safety colors.

<b>Utility Color Codes</b>		©SCTE
<b>Utility</b>		<b>Color Code</b>
Gas, Oil, Steam, Petroleum		Yellow
Electric		Red
Telecommunications		Orange
Water		Blue
Sewer or Drain		Green
Pending Work or New Construction		White
Temporary Markouts		Pink
Reclaimed Water, Irrigation & Slurry		Purple

## 1.2 National Electric Code

The purpose of the National Electric Code (NEC) is “the practical safeguarding of persons and property from hazards arising from the use of electricity.” The National Electric Code is not a set of laws, but a guideline of practices issued by the National Fire Protection Association for the installation of electrical wiring and equipment in the United States. As a guideline, the NEC can only be enforced if your state, county, and/or town have adopted it. Not all communities adopt the NEC, and some adopt the NEC but have additional requirements. Also, not all locations have adopted the NEC in its most recent form. The NEC updates its code every three years. Following are minimum distances.

## Minimum Drop Clearances

Location	Distance
Public street, alley, nonresidential driveways, parking lots, any area subject to truck traffic	18 feet
Residential driveways	12 feet
Pedestrian traffic	10 feet
Track rail of railroad	23.5 feet
Water (no sailboats)	14 feet
Flat roof buildings	8 feet
Peak roof buildings	3 feet
Roof overhang	18 inches
Lightning rod conductors	6 feet
Signs, chimneys, billboards, radio and TV antennas, tanks - just about everything except buildings or bridges	3 feet

### 1.3 Housing Opening and Closing Examples for Nodes and Amplifiers

When opening and closing nodes and amplifiers, make sure you are following the torque specifications provided by the manufacturer. Some general examples of lid bolt tightening sequences are provided below.

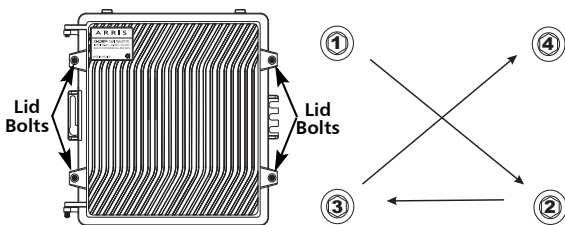

**4 Bolt Tightening Sequence**

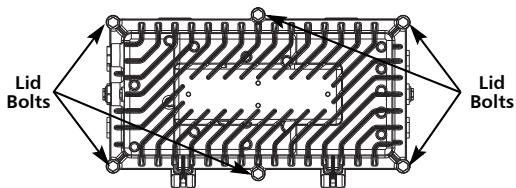

**6 Bolt Tightening Sequence**

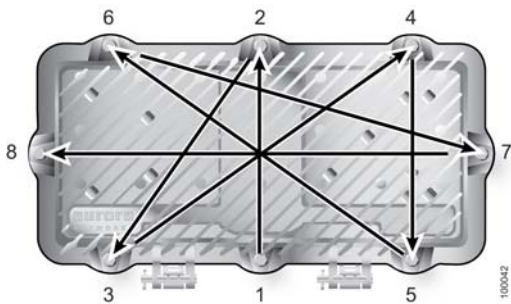

**8 Bolt Tightening Sequence**

Channel Number/ Letter	Channel Bandedge (MHz)	Center Frequency (MHz)	Bandwidth (MHz)
24 K	222 - 228	225.2625	260.84
26 M	234 - 240	237.2625	266.84
27 N	240 - 246	243.2625	272.84
29 P	246 - 252	249.2625	278.84
31 Q	252 - 258	255.2625	284.84
33 R	258 - 264	261.2625	290.84
35 Q	264 - 270	267.2625	296.84
37 S	270 - 276	273.2625	302.84
39 T	276 - 282	279.2625	308.84
41 U	282 - 288	285.2625	314.84
43 V	288 - 294	291.2625	320.84
45 W	294 - 300	297.2625	326.84
47 AA	300 - 306	303.2625	332.84
49 AB	306 - 312	309.2625	338.84
51 AC	312 - 318	315.2625	344.84
53 AD	318 - 324	321.2625	350.84
55 AE	324 - 330	327.2625	356.84
57 AF	330 - 336	333.2750	362.84
59 AG	336 - 342	339.2625	368.84
61 AH	342 - 348	345.2625	374.84
63 AI	348 - 354	351.2625	380.84
65 AJ	354 - 360	357.2625	386.84
67 AK	360 - 366	363.2625	392.84
69 AL	366 - 372	369.2625	398.84
71 AM	372 - 378	375.2625	404.84
73 AN	378 - 384	381.2625	410.84
75 AO	384 - 390	387.2625	416.84
77 AP	390 - 396	393.2625	422.84
79 AQ	396 - 402	399.2625	428.84
81 AR	402 - 408	405.2500	434.84
83 AS	408 - 414	411.2500	440.84
85 AT	414 - 420	417.2500	446.84
87 AU	420 - 426	423.2500	452.84
89 AV	426 - 432	429.2500	458.84
91 AW	432 - 438	435.2500	464.84
93 AX	438 - 444	441.2500	470.84
95 AY	444 - 450	447.2500	476.84

# RF DATA

## 2.1 Television Channel Frequency Data

Channels T-7 through T-13 are return channels.

### FCC Frequency Allocation

Channel Number/ Letter	Channel Bandedge (MHz)	Visual Carrier (MHz)	Chroma Carrier (MHz)	Aural Carrier (MHz)	Wave-length (in)
T-7	5.75 – 11.75	7.0000	10.58	11.5000	
T-8	11.75 – 17.75	13.0000	16.58	17.5000	
T-9	17.75 – 23.75	19.0000	22.58	23.5000	
T-10	23.75 – 29.75	25.0000	28.58	29.5000	
T-11	29.75 – 35.75	31.0000	34.58	35.5000	
T-12	35.75 – 41.75	37.0000	40.58	41.5000	
T-13	41.75 – 47.75	43.0000	46.58	47.5000	
2	54 – 60	55.2500	58.83	59.7500	213.8
3	60 – 66	61.2500	64.83	65.7500	192.8
4	66 – 72	67.2500	70.83	71.7500	175.6
A-8	72 – 76	Guardband			
5	76 – 82	77.2500	80.83	81.7500	152.9
6	82 – 88	83.2500	86.83	87.7500	141.9
Guardband					
95	A-5 90 – 96	91.2500	94.83	95.7500	
96	A-4 96 – 102	97.2500	100.83	101.7500	
97	A-3 102 – 108	103.2500	106.83	107.7500	
98	A-2 108 – 114	109.2750	112.855	113.7750	
99	A-1 114 – 120	115.2750	118.855	119.7750	
14	A 120 – 126	121.2625	124.84	125.7625	25.1
15	B 126 – 132	127.2625	130.84	131.7625	24.7
16	C 132 – 138	133.2625	136.84	137.7625	24.4
17	D 138 – 144	139.2500	142.83	143.7500	24.1
18	E 144 – 150	145.2500	148.83	149.7500	23.8
19	F 150 – 156	151.2500	154.83	155.7500	23.6
20	G 156 – 162	157.2500	160.83	161.7500	23.3
21	H 162 – 168	163.2500	166.83	167.7500	23.0
22	I 168 – 174	169.2500	172.83	173.7500	22.7
7	174 – 180	175.2500	178.83	179.7500	67.4
8	180 – 186	181.2500	184.83	185.7500	65.2
9	186 – 192	187.2500	190.83	191.7500	63.1
10	192 – 198	193.2500	196.83	197.7500	61.1
11	198 – 204	199.2500	202.83	203.7500	59.3
12	204 – 210	205.2500	208.83	209.7500	57.5
13	210 – 216	211.2500	214.83	215.7500	55.9
23	J 216 – 222	217.2500	220.83	221.7500	22.5
24	K 222 – 228	223.2500	226.83	227.7500	22.2
25	L 228 – 234	229.2625	232.84	233.7625	22.0
26	M 234 – 240	235.2625	238.84	239.7625	21.7
27	N 240 – 246	241.2625	244.84	245.7625	21.5

## FCC Frequency Allocation (cont'd)

Channel Number/ Letter	Channel Bandedge (MHz)	Visual Carrier (MHz)	Chroma Carrier (MHz)	Aural Carrier (MHz)	Wave-length (in)	
28	O	246 – 252	247.2625	250.84	251.7625	21.3
29	P	252 – 258	253.2625	256.84	257.7625	21.0
30	Q	258 – 264	259.2625	262.84	263.7625	20.8
31	R	264 – 270	265.2625	268.84	269.7625	20.6
32	S	270 – 276	271.2625	274.84	275.7625	20.4
33	T	276 – 282	277.2625	280.84	281.7625	20.2
34	U	282 – 288	283.2625	286.84	287.7625	20.0
35	V	288 – 294	289.2625	292.84	293.7625	19.8
36	W	294 – 300	295.2625	298.84	299.7625	19.6
37	AA	300 – 306	301.2625	304.84	305.7625	Radio Astronomy
38	BB	306 – 312	307.2625	310.84	311.7625	19.2
39	CC	312 – 318	313.2625	316.84	317.7625	19.0
40	DD	318 – 324	319.2625	322.84	323.7625	18.8
41	EE	324 – 330	325.2625	328.84	329.7625	18.7
42	FF	330 – 336	331.2750	334.85	335.7750	18.5
43	GG	336 – 342	337.2625	340.84	341.7625	18.3
44	HH	342 – 348	343.2625	346.84	347.7625	18.1
45	II	348 – 354	349.2625	352.84	353.7625	18.0
46	JJ	354 – 360	355.2625	358.84	359.7625	17.8
47	KK	360 – 366	361.2625	364.84	365.7625	17.6
48	LL	366 – 372	367.2625	370.84	371.7625	17.5
49	MM	372 – 378	373.2625	376.84	377.7625	17.3
50	NN	378 – 384	379.2625	382.84	383.7625	17.2
51	OO	384 – 390	385.2625	388.84	389.7625	17.0
52	PP	390 – 396	391.2625	394.84	395.7625	
53	QQ	396 – 402	397.2625	400.84	401.7625	
54	RR	402 – 408	403.2500	406.83	407.7500	
55	SS	408 – 414	409.2500	412.83	413.7500	
56	TT	414 – 420	415.2500	418.83	419.7500	
57	UU	420 – 426	421.2500	424.83	425.7500	
58	VV	426 – 432	427.2500	430.83	431.7500	
59	WW	432 – 438	433.2500	436.83	437.7500	
60	XX	438 – 444	439.2500	442.83	443.7500	
61	YY	444 – 450	445.2500	448.83	449.7500	
62	ZZ	450 – 456	451.2500	454.83	455.7500	
63	AAA	456 – 462	457.2500	460.83	461.7500	
64	BBB	462 – 468	463.2500	466.83	467.7500	
65	CCC	468 – 474	469.2500	472.83	473.7500	
66	DDD	474 – 480	475.2500	478.83	479.7500	
67	EEE	480 – 486	481.2500	484.83	485.7500	
68	FFF	486 – 492	487.2500	490.83	491.7500	

## FCC Frequency Allocation (cont'd)

Channel Number/ Letter	Channel Bandedge (MHz)	Visual Carrier (MHz)	Chroma Carrier (MHz)	Aural Carrier (MHz)	Wave-length (in)
69	GGG	492 – 498	493.2500	496.83	497.7500
70	HHH	498 – 504	499.2500	502.83	503.7500
71	III	504 – 510	505.2500	508.83	509.7500
72	JJJ	510 – 516	511.2500	514.83	515.7500
73	KKK	516 – 522	517.2500	520.83	521.7500
74	LLL	522 – 528	523.2500	526.83	527.7500
75	MMM	528 – 534	529.2500	532.83	533.7500
76	NNN	534 – 540	535.2500	538.83	539.7500
77	OOO	540 – 546	541.2500	544.83	545.7500
78	PPP	546 – 552	547.2500	550.83	551.7500
79	QQQ	552 – 558	553.2500	556.83	557.7500
80	RRR	558 – 564	559.2500	562.83	563.7500
81	SSS	564 – 570	565.2500	568.83	569.7500
82	TTT	570 – 576	571.2500	574.83	575.7500
83	UUU	576 – 582	577.2500	580.83	581.7500
84	VVV	582 – 588	583.2500	586.83	587.7500
85	WWW	588 – 594	589.2500	592.83	593.7500
86	XXX	594 – 600	595.2500	598.83	599.7500
87	YYY	600 – 606	601.2500	604.83	605.7500
88	ZZZ	606 – 612	607.2500	610.83	611.7500
89		612 – 618	613.2500	616.83	617.7500
90		618 – 624	619.2500	622.83	623.7500
91		624 – 630	625.2500	628.83	629.7500
92		630 – 636	631.2500	634.83	635.7500
93		636 – 642	637.2500	640.83	641.7500
94		642 – 648	643.2500	646.83	647.7500
100		648 – 654	649.2500	652.83	653.7500
101		654 – 660	655.2500	658.83	659.7500
102		660 – 666	661.2500	664.83	665.7500
103		666 – 672	667.2500	670.83	671.7500
104		672 – 678	673.2500	676.83	677.7500
105		678 – 684	679.2500	682.83	683.7500
106		684 – 690	685.2500	688.83	689.7500
107		690 – 696	691.2500	694.83	695.7500
108		696 – 702	697.2500	700.83	701.7500
109		702 – 708	703.2500	706.83	707.7500
110		708 – 714	709.2500	712.83	713.7500
111		714 – 720	715.2500	718.83	719.7500
112		720 – 726	721.2500	724.83	725.7500
113		726 – 732	727.2500	730.83	731.7500
114		732 – 738	733.2500	736.83	737.7500
115		738 – 744	739.2500	742.83	743.7500
116		744 – 750	745.2500	748.83	749.7500



## FCC Frequency Allocation (cont'd)

Channel Number/ Letter	Channel Bandedge (MHz)	Visual Carrier (MHz)	Chroma Carrier (MHz)	Aural Carrier (MHz)	Wave-length (in)
117	750 – 756	751.2500	754.83	755.7500	
118	756 – 762	757.2500	760.83	761.7500	
119	762 – 768	763.2500	766.83	767.7500	
120	768 – 774	769.2500	772.83	773.7500	
121	774 – 780	775.2500	778.83	779.7500	
122	780 – 786	781.2500	784.83	785.7500	
123	786 – 792	787.2500	790.83	791.7500	
124	792 – 798	793.2500	796.83	797.7500	
125	798 – 804	799.2500	802.83	803.7500	
126	804 – 810	805.2500	808.83	809.7500	
127	810 – 816	811.2500	814.83	815.7500	
128	816 – 822	817.2500	820.83	821.7500	
129	822 – 828	823.2500	826.83	827.7500	
130	828 – 834	829.2500	832.83	833.7500	
131	834 – 840	835.2500	838.83	839.7500	
132	840 – 846	841.2500	844.83	845.7500	
133	846 – 852	847.2500	850.83	851.7500	
134	852 – 858	853.2500	856.83	857.7500	
135	858 – 864	859.2500	862.83	863.7500	
136	864 – 870	865.2500	868.83	869.7500	
137	870 – 876	871.2500	874.83	875.7500	
138	876 – 882	877.2500	880.83	881.7500	
139	882 – 888	883.2500	886.83	887.7500	
140	888 – 894	889.2500	892.83	893.7500	
141	894 – 900	895.2500	898.83	899.7500	
142	900 – 906	901.2500	904.83	905.7500	
143	906 – 912	907.2500	910.83	911.7500	
144	912 – 918	913.2500	916.83	917.7500	
145	918 – 924	919.2500	922.83	923.7500	
146	924 – 930	925.2500	928.83	929.7500	
147	930 – 936	931.2500	934.83	935.7500	
148	936 – 942	937.2500	940.83	941.7500	
149	942 – 948	943.2500	946.83	947.7500	
150	948 – 954	949.2500	952.83	953.7500	
151	954 – 960	955.2500	958.83	959.7500	
152	960 – 966	961.2500	964.83	965.7500	
153	966 – 972	967.2500	970.83	971.7500	
154	972 – 978	973.2500	976.83	977.7500	
155	978 – 984	979.2500	982.83	983.7500	
156	984 – 990	985.2500	988.83	989.7500	
157	990 – 996	991.2500	994.83	995.7500	
158	996 – 1002	997.2500	1000.83	1001.750	

## 2.2 North America—CCIR System M

### CCIR System M Frequencies

Channel Number		Picture Carrier			Digital Carrier STD and IRC	
GI	EIA	STD	HRC	IRC	8/16VSB	QAM
54	1	N/A	72.0036	73.2625	*72.31	*75
2	2	55.2500	54.0027	55.2625	54.31	57
3	3	61.2500	60.0030	61.2625	60.31	63
4	4	67.2500	66.0033	67.2625	66.31	69
5	5	77.2500	N/A	N/A	76.31	79
6	6	83.2500	N/A	N/A	82.31	85
55	5	N/A	78.0039	79.2625	76.31	79
56	6	N/A	84.0042	85.2625	82.31	85
7	7	175.2500	174.0087	175.2625	174.31	177
8	8	181.2500	180.0090	181.2625	180.31	183
9	9	187.2500	186.0093	187.2625	186.31	189
10	10	193.2500	192.0096	193.2625	192.31	195
11	11	199.2500	198.0099	199.2625	198.31	201
12	12	205.2500	204.0102	205.2625	204.31	207
13	13	211.2500	210.0105	211.2625	210.31	213
14	14	121.2625	120.0060	121.2625	120.31	123
15	15	127.2625	126.0063	127.2625	126.31	129
16	16	133.2625	132.0066	133.2625	132.31	135
17	17	139.2500	138.0069	139.2625	138.31	141
18	18	145.2500	144.0072	145.2625	144.31	147
19	19	151.2500	150.0075	151.2625	150.31	153
20	20	157.2500	156.0078	157.2625	156.31	159
21	21	163.2500	162.0081	163.2625	162.31	165
22	22	169.2500	168.0084	169.2625	168.31	171
23	23	217.2500	216.0108	217.2625	216.31	219
24	24	223.2500	222.0111	223.2625	222.31	225
25	25	229.2625	228.0114	229.2625	228.31	231
26	26	235.2625	234.0117	235.2625	234.31	237
27	27	241.2625	240.0120	241.2625	240.31	243
28	28	247.2625	246.0123	247.2625	246.31	249
29	29	253.2625	252.0126	253.2625	252.31	255
54	1	N/A	72.0036	73.2625	*72.31	*75
2	2	55.2500	54.0027	55.2625	54.31	57
3	3	61.2500	60.0030	61.2625	60.31	63
4	4	67.2500	66.0033	67.2625	66.31	69
5	5	77.2500	N/A	N/A	76.31	79
6	6	83.2500	N/A	N/A	82.31	85
55	5	N/A	78.0039	79.2625	76.31	79
56	6	N/A	84.0042	85.2625	82.31	85
7	7	175.2500	174.0087	175.2625	174.31	177
8	8	181.2500	180.0090	181.2625	180.31	183

## CCIR System M Frequencies (cont'd)

Channel Number		Picture Carrier			Digital Carrier STD and IRC	
GI	EIA	STD	HRC	IRC	8/16VSB	QAM
9	9	187.2500	186.0093	187.2625	186.31	189
10	10	193.2500	192.0096	193.2625	192.31	195
11	11	199.2500	198.0099	199.2625	198.31	201
12	12	205.2500	204.0102	205.2625	204.31	207
13	13	211.2500	210.0105	211.2625	210.31	213
14	14	121.2625	120.0060	121.2625	120.31	123
15	15	127.2625	126.0063	127.2625	126.31	129
16	16	133.2625	132.0066	133.2625	132.31	135
17	17	139.2500	138.0069	139.2625	138.31	141
18	18	145.2500	144.0072	145.2625	144.31	147
19	19	151.2500	150.0075	151.2625	150.31	153
30	30	259.2625	258.0129	259.2625	258.31	261
31	31	265.2625	264.0132	265.2625	264.31	267
32	32	271.2625	270.0135	271.2625	270.31	273
33	33	277.2625	276.0138	277.2625	276.31	279
34	34	283.2625	282.0141	283.2625	282.31	285
35	35	289.2625	288.0144	289.2625	288.31	291
36	36	295.2625	294.0147	295.2625	294.31	297
37	37	301.2625	300.0150	301.2625	300.31	303
38	38	307.2625	306.0153	307.2625	306.31	309
39	39	313.2625	312.0156	313.2625	312.31	315
40	40	319.2625	318.0159	319.2625	318.31	321
41	41	325.2625	324.0162	325.2625	324.31	327
42	42	331.2750	330.0165	331.2750	330.31	333
43	43	337.2625	336.0168	337.2625	336.31	339
44	44	343.2625	342.0171	343.2625	342.31	345
45	45	349.2625	348.0174	349.2625	348.31	351
46	46	355.2625	354.0177	355.2625	354.31	357
47	47	361.2625	360.0180	361.2625	360.31	363
48	48	367.2625	366.0183	367.2625	366.31	369
49	49	373.2625	372.0186	373.2625	372.31	375
50	50	379.2625	378.0189	379.2625	378.31	381
51	51	385.2625	384.0192	385.2625	384.31	387
52	52	391.2625	390.0195	391.2625	390.31	393
53	53	397.2625	396.0198	397.2625	396.31	399
62	54	403.2500	402.0201	403.2625	402.31	405
63	55	409.2500	408.0204	409.2625	408.31	411
64	56	415.2500	414.0207	415.2625	414.31	417
65	57	421.2500	420.0210	421.2625	420.31	423
66	58	427.2500	426.0213	427.2625	426.31	429
67	59	433.2500	432.0216	433.2625	432.31	435
68	60	439.2500	438.0219	439.2625	438.31	441
69	61	445.2500	444.0222	445.2625	444.31	447

## CCIR System M Frequencies (cont'd)

Channel Number		Picture Carrier			Digital Carrier STD and IRC	
GI	EIA	STD	HRC	IRC	8/16VSB	QAM
70	62	451.2500	450.0225	451.2625	450.31	453
71	63	457.2500	456.0228	457.2625	456.31	459
72	64	463.2500	462.0231	463.2625	462.31	465
73	65	469.2500	468.0234	469.2625	468.31	471
74	66	475.2500	474.0237	475.2625	474.31	477
75	67	481.2500	480.0240	481.2625	480.31	483
76	68	487.2500	486.0243	487.2625	486.31	489
77	69	493.2500	492.0246	493.2625	492.31	495
78	70	499.2500	498.0249	499.2625	498.31	501
79	71	505.2500	504.0252	505.2625	504.31	507
80	72	511.2500	510.0255	511.2625	510.31	513
81	73	517.2500	516.0258	517.2625	516.31	519
82	74	523.2500	522.0261	523.2625	522.31	525
83	75	529.2500	528.0264	529.2625	528.31	531
84	76	535.2500	534.0267	535.2625	534.31	537
85	77	541.2500	540.0270	541.2625	540.31	543
86	78	547.2500	546.0273	547.2625	546.31	549
87	79	553.2500	552.0276	553.2625	552.31	555
88	80	559.2500	558.0279	559.2625	558.31	561
89	81	565.2500	564.0282	565.2625	564.31	567
90	82	571.2500	570.0285	571.2625	570.31	573
91	83	577.2500	576.0288	577.2625	576.31	579
92	84	583.2500	582.0291	583.2625	582.31	585
93	85	589.2500	588.0294	589.2625	588.31	591
94	86	595.2500	594.0297	595.2625	594.31	597
95	87	601.2500	600.0300	601.2625	600.31	603
96	88	607.2500	606.0303	607.2625	606.31	609
97	89	613.2500	612.0306	613.2625	612.31	615
98	90	619.2500	618.0309	619.2625	618.31	621
99	91	625.2500	624.0312	625.2625	624.31	627
100	92	631.2500	630.0315	631.2625	630.31	633
101	93	637.2500	636.0318	637.2625	636.31	639
102	94	643.2500	642.0321	643.2625	642.31	645
57	95	91.2500	90.0045	91.2625	90.31	93
58	96	97.2500	96.0048	97.2625	96.31	99
59	97	103.2500	102.0051	103.2625	102.31	105
60	98	109.2750	108.0250	109.2750	108.31	111
61	99	115.2750	114.0250	115.2750	114.31	117
103	100	649.2500	648.0324	649.2625	648.31	651
104	101	655.2500	654.0327	655.2625	654.31	657
105	102	661.2500	660.0330	661.2625	660.31	663
106	103	667.2500	666.0333	667.2625	666.31	669
107	104	673.2500	672.0336	673.2625	672.31	675

## CCIR System M Frequencies (cont'd)

Channel Number		Picture Carrier			Digital Carrier STD and IRC	
GI	EIA	STD	HRC	IRC	8/16VSB	QAM
108	105	679.2500	678.0339	679.2625	678.31	681
109	106	685.2500	684.0342	685.2625	684.31	687
110	107	691.2500	690.0345	691.2625	690.31	693
111	108	697.2500	696.0348	697.2625	696.31	699
112	109	703.2500	702.0351	703.2625	702.31	705
113	110	709.2500	708.0354	709.2625	708.31	711
114	111	715.2500	714.0357	715.2625	714.31	717
115	112	721.2500	720.0360	721.2625	720.31	723
116	113	727.2500	726.0363	727.2625	726.31	729
117	114	733.2500	732.0366	733.2625	732.31	735
118	115	739.2500	738.0369	739.2625	738.31	741
119	116	745.2500	744.0372	745.2625	744.31	747
120	117	751.2500	750.0375	751.2625	750.31	753
121	118	757.2500	756.0378	757.2625	756.31	759
122	119	763.2500	762.0381	763.2625	762.31	765
123	120	769.2500	768.0384	769.2625	768.31	771
124	121	775.2500	774.0387	775.2625	774.31	777
125	122	781.2500	780.0390	781.2625	780.31	783
126	123	787.2500	786.0393	787.2625	786.31	789
127	124	793.2500	792.0396	793.2625	792.31	795
128	125	799.2500	798.0399	799.2625	798.31	801
129	126	805.2500	804.0402	805.2625	804.31	807
130	127	811.2500	810.0405	811.2625	810.31	813
131	128	817.2500	816.0408	817.2625	816.31	819
132	129	823.2500	822.0411	823.2625	822.31	825
133	130	829.2500	828.0414	829.2625	828.31	831
134	131	835.2500	834.0417	835.2625	834.31	837
135	132	841.2500	840.0420	841.2625	840.31	843
136	133	847.2500	846.0423	847.2625	846.31	849
137	134	853.2500	852.0426	853.2625	852.31	855
138	135	859.2500	858.0429	859.2625	858.31	861
139	136	865.2500	864.0432	865.2625	864.31	867
140	137	871.2500	870.0435	871.2625	870.31	873
141	138	877.2500	876.0438	877.2625	876.31	879
142	139	883.2500	882.0441	883.2625	882.31	885
143	140	889.2500	888.0444	889.2625	888.31	891
144	141	895.2500	894.0447	895.2625	894.31	897
145	142	901.2500	900.0450	901.2625	900.31	903
146	143	907.2500	906.0453	907.2625	906.31	909
147	144	913.2500	912.0456	913.2625	912.31	905
148	145	919.2500	918.0459	919.2625	918.31	921
149	146	925.2500	924.0462	925.2625	924.31	927
150	147	931.2500	930.0465	931.2625	930.31	933

## CCIR System M Frequencies (cont'd)

Channel Number		Picture Carrier			Digital Carrier STD and IRC	
GI	EIA	STD	HRC	IRC	8/16VSB	QAM
151	148	937.2500	936.0468	937.2625	936.31	939
152	149	943.2500	942.0471	943.2625	942.31	945
153	150	949.2500	948.0474	949.2625	948.31	951
154	151	955.2500	954.0477	955.2625	954.31	957
155	152	961.2500	960.0480	961.2625	960.31	963
156	153	967.2500	966.0483	967.2625	966.31	969
157	154	973.2500	972.0486	973.2625	972.31	975
158	155	979.2500	978.0489	979.2625	978.31	981
159	156	985.2500	984.0492	985.2625	984.31	987
160	157	991.2500	990.0495	991.2625	990.31	993
161	158	997.2500	996.0498	997.2625	996.31	999

*Sound carrier is 4.5 MHz above picture carrier. Color subcarrier is 3.579545 MHz above picture carrier.*

EIA: Electronic Industries Association, Washington, D.C.

### 2.3 Sub-VHF Frequencies

Channel	Picture	Color	Sound
T7	7.00	10.58	11.50
T8	13.00	16.58	17.50
T9	19.00	22.58	23.50
T10	25.00	28.58	29.50
T11	31.00	34.58	35.50
T12	37.00	40.58	41.50
T13	43.00	46.58	47.50

## 2.4 Western Europe—Off-Air CCIR System B/G Frequencies

Channel	Picture	Sound	Channel	Picture	Sound
E-2	48.25	53.75	E-40	623.25	628.75
E-3	55.25	60.75	E-41	631.25	636.75
E-4	62.25	67.75	E-42	639.25	644.75
E-5	175.25	180.75	E-43	647.25	652.75
E-6	182.25	187.75	E-44	655.25	660.75
E-7	189.25	194.75	E-45	663.25	668.75
E-8	196.25	201.75	E-46	671.25	676.75
E-9	203.25	208.75	E-47	679.25	684.75
E-10	210.25	215.75	E-48	687.25	692.75
E-11	217.25	222.75	E-49	695.25	700.75
E-12	224.25	229.75	E-50	703.25	708.75
E-21	471.25	476.75	E-51	711.25	716.75
E-22	479.25	484.75	E-52	719.25	724.75
E-23	487.25	492.75	E-53	727.25	732.75
E-24	495.25	500.75	E-54	735.25	740.75
E-25	503.25	508.75	E-55	743.25	748.75
E-26	511.25	516.75	E-56	751.25	756.75
E-27	519.25	524.75	E-57	759.25	764.75
E-28	527.25	532.75	E-58	767.25	772.75
E-29	535.25	540.75	E-59	775.25	780.75
E-30	543.25	548.75	E-60	783.25	788.75
E-31	551.25	556.75	E-61	791.25	796.75
E-32	559.25	564.75	E-62	799.25	804.75
E-33	567.25	572.75	E-63	807.25	812.75
E-34	575.25	580.75	E-64	815.25	820.75
E-35	583.25	588.75	E-65	823.25	828.75
E-36	591.25	596.75	E-66	831.25	836.75
E-37	599.25	604.75	E-67	839.25	844.75
E-38	607.25	612.75	E-68	847.25	852.75
E-39	615.25	620.75	E-69	855.25	860.75

## 2.5 Great Britain—CCIR System Frequencies

Channel	Picture	Sound	Channel	Picture	Sound
21	471.25	477.25	46	671.25	677.25
22	479.25	485.25	47	679.25	685.25
23	487.25	493.25	48	687.25	693.25
24	495.25	501.25	49	695.25	701.25
25	503.25	509.25	50	703.25	709.25
26	511.25	517.25	51	711.25	717.25
27	519.25	525.25	52	719.25	725.25
28	527.25	533.25	53	727.25	733.25
29	535.25	541.25	54	735.25	741.25

Channel	Picture	Sound	Channel	Picture	Sound
30	543.25	549.25	55	743.25	749.25
31	551.25	557.25	56	751.25	757.25
32	559.25	565.25	57	759.25	765.25
33	567.25	573.25	58	767.25	773.25
34	575.25	581.25	59	775.25	781.25
35	583.25	589.25	60	783.25	789.25
36	591.25	597.25	61	791.25	797.25
37	599.25	605.25	62	799.25	805.25
38	607.25	613.25	63	807.25	813.25
39	615.25	621.25	64	815.25	821.25
40	623.25	629.25	65	823.25	829.25
41	631.25	637.25	66	831.25	837.25
42	639.25	645.25	67	839.25	845.25
43	647.25	653.25	68	847.25	853.25
44	655.25	661.25	69	855.25	861.25
45	663.25	669.25			

## 2.6 Western CCIR System B/G Cable Frequencies

Range	Channel	Freq(MHz)	Range	Channel	Freq(MHz)
Band I	2	48.25	Band V	38	610.00
	3	55.25		39	618.00
	4	62.25		40	626.00
FM	87.5-108	41		634.00	
VHF mid-band	S4	126.25		42	642.00
	S5	133.25		43	650.00
	S6	140.25		44	658.00
	S7	147.25		45	666.00
	S8	154.25		46	674.00
	S9	161.25		47	672.00
	S10	168.25		48	690.00
Band III	5	175.25		49	698.00
	6	182.25	50	706.00	
	7	189.25	51	714.00	
	8	196.25	52	722.00	
	9	203.25	53	730.00	
	10	210.25	54	738.00	
	11	217.25	55	746.00	
	12	224.25	56	754.00	



Range	Channel	Freq(MHz)	Range	Channel	Freq(MHz)
VHF superband	S11	231.25	Band V (cont)	57	732.00
	S12	238.25		58	770.00
	S13	245.25		59	778.00
	S14	252.25		60	786.00
Band IV	21	471.25		61	794.00
	22	479.25		62	802.00
	23	487.25		63	810.00
	24	495.25		64	818.00
	25	503.25		65	826.00
	26	511.25		66	834.00
	27	519.25		67	842.00
	28	527.25		68	850.00
	29	535.25		69	858.00
	30	543.25		S16	266.25
	31	551.25	S17	273.25	
	32	559.25	S18	280.25	
	33	567.25	S19	287.25	
34	575.25	S20	294.25		
35	583.25	S21	303.25		
36	591.25	S22	311.25		
37	599.25	S23	319.25		
			S24	327.25	
			S25	335.25	
			S26	343.25	
			S27	351.25	
			S28	359.25	
			S29	367.25	
			S30	375.25	
			S31	383.25	
			S32	391.25	
			S33	399.25	
			S34	407.25	
			S35	415.25	
			S36	423.25	
			S37	431.25	
			S38	439.25	
			S39	447.25	

## 2.7 China—CCIR System D

Channel	F-Scope	Digital Center	Picture	Sound
DS1	48.5-56.5	52.5	49.75	56.25
DS2	56.5-64.5	60.5	57.75	64.25
DS3	64.5-72.5	68.5	65.75	72.25
DS4	76-84	80	77.25	83.75
DS5	84-92	88	85.25	91.75
FM	87-108			
Z1	111-119	115	112.25	118.75
Z2	119-127	123	120.25	126.75
Z3	127-135	131	128.25	134.75
Z4	135-143	139	136.25	142.75
Z5	143-151	147	144.25	150.75
Z6	151-159	155	152.25	158.75
Z7	159-167	163	160.25	166.75
DS6	167-175	171	168.25	174.75
DS7	175-183	179	176.25	182.75
DS8	183-191	187	184.25	190.75
DS9	191-199	195	192.25	198.75
DS10	199-207	203	200.25	206.75
DS11	207-215	211	208.25	214.75
DS12	215-223	219	216.25	222.75
Z8	223-231	227	224.25	230.75
Z9	231-239	235	232.25	238.75
Z10	239-247	243	240.25	246.75
Z11	247-255	251	248.25	254.75
Z12	255-263	259	256.25	262.75
Z13	263-271	267	264.25	270.75
Z14	271-279	275	272.25	278.75
Z15	279-287	283	280.25	286.75
Z16	287-295	291	288.25	294.75
Z17	295-303	299	296.25	302.75
Z18	303-311	307	304.25	310.75
Z19	311-319	315	312.25	318.75
Z20	319-327	323	320.25	326.75
Z21	327-335	331	328.25	334.75
Z22	335-343	339	336.25	342.75
Z23	343-351	347	344.25	350.75
Z24	351-359	355	352.25	358.75
Z25	359-367	363	360.25	366.75
Z26	367-375	371	368.25	374.75
Z27	375-383	379	376.25	382.75
Z28	383-391	387	384.25	390.75
Z29	391-399	395	392.25	398.75
Z30	399-407	403	400.25	406.75
Z31	407-415	411	408.25	414.75

Channel	F-Scope	Digital Center	Picture	Sound
Z32	415-423	419	416.25	422.75
Z33	423-431	427	424.25	430.75
DS13	470-478	474	471.25	477.75
DS14	478-486	482	479.25	485.75
DS15	486-494	490	487.25	493.75
DS16	494-502	498	495.25	501.75
DS17	502-510	506	503.25	509.75
DS18	510-518	514	511.25	517.75
DS19	518-526	522	519.25	525.75
DS20	526-534	530	527.25	533.75
DS21	534-542	538	535.25	541.75
DS22	542-550	546	543.25	549.75
DS23	550-558	554	551.25	557.75
DS24	558-566	562	559.25	565.75
Z39	566-574	570	567.25	573.75
Z40	574-582	578	575.25	581.75
Z41	582-590	586	583.25	589.75
Z42	590-598	594	591.25	597.75
Z43	598-606	602	599.25	605.75
DS25	606-614	610	607.25	613.75
DS26	614-622	618	615.25	621.75
DS27	622-630	626	623.25	629.75
DS28	630-638	634	631.25	637.75
DS29	638-646	642	639.25	645.75
DS30	646-654	650	647.25	653.75
DS31	654-662	658	655.25	661.75
DS32	662-670	666	663.25	669.75
DS33	670-678	674	671.25	677.75
DS34	678-686	682	679.25	685.75
DS35	686-694	690	687.25	693.75
DS36	694-702	698	695.25	701.75
DS37	702-710	706	703.25	709.75
DS38	710-718	714	711.25	717.75
DS39	718-726	722	719.25	725.75
DS40	726-734	730	727.25	733.75
DS41	734-742	738	735.25	741.75
DS42	742-750	746	743.25	749.75
DS43	750-758	754	751.25	757.75
DS44	758-766	762	759.25	765.75
DS45	766-774	770	767.25	773.75
DS46	774-782	778	775.25	781.75
DS47	782-790	786	783.25	789.75
DS48	790-798	794	791.25	797.75
DS49	798-806	802	799.25	805.75
DS50	806-814	810	807.25	813.75
DS51	814-822	818	815.25	821.75

Channel	F-Scope	Digital Center	Picture	Sound
DS52	822-830	826	823.25	829.75
DS53	830-838	834	831.25	837.75

## 2.8 CCIR Television Transmission Characteristics

System	Lines	Field Freq (Hz)	Line Freq (Hz)	Chan Width (MHz)	Vid/Snd Spacing (MHz)	Vest SB (MHz)	Visual Mod	Sound Mod
								FM
B/G	625	50	15.625	7/8	+5.5	0.75	neg	FM
								AM
								FM
								FM
								FM
								FM
								FM
								AM
								FM
								FM
C	625	50	15.625	7	+5.5	0.75	pos	AM
								FM
								FM
								FM
								FM
								FM
								FM
								AM
								FM
								FM
D/K	625	50	15.625	8	+6.5	0.75	neg	FM
								FM
								FM
								FM
								FM
								FM
								FM
								AM
								FM
								FM
H	625	50	15.625	8	+5.5	1.25	neg	FM
								FM
								FM
								FM
								FM
								FM
								FM
								AM
								FM
								FM
I	625	50	15.625	8	+6.0	1.25	neg	FM
								FM
								FM
								FM
								FM
								FM
								FM
								AM
								FM
								FM
K1	625	50	15.625	8	+6.5	1.25	neg	FM
								FM
								FM
								FM
								FM
								FM
								FM
								AM
								FM
								FM
L	525	50	15.625	8	+6.5	1.25	pos	AM
								FM
								FM
								FM
								FM
								FM
								FM
								AM
								FM
								FM
M	525	60	15.734	6	+4.5	0.75	neg	FM
								FM
								FM
								FM
								FM
								FM
								FM
								AM
								FM
								FM
N	625	50	15.625	6	+4.5	0.75	neg	FM
								FM
								FM
								FM
								FM
								FM
								FM
								AM
								FM
								FM

CCIR: Committé Consulatif International Radio communications

NTSC: National Television Systems Committee

PAL: Phase Alternation by Line

SECAM: Sequential Color with Memory

OIRT: Organisation Internationale Radiodiffusion—Télévision

## 2.9 CommScope MC<sup>2</sup> Coaxial Cable

Maximum loss at 68 °F (dB/100 ft)<sup>1</sup>

Frequency (MHz)	Series				
	440	500	650	750	1000
5	0.17	0.14	0.11	0.10	0.07
30	0.41	0.35	0.28	0.25	0.18
55	0.56	0.48	0.38	0.34	0.24
211	1.11	0.9	0.76	0.66	0.49
250	1.21	1.03	0.83	0.72	0.35
270	1.26	1.08	0.86	0.75	0.54
300	1.33	1.14	0.91	0.79	0.60
325	1.39	1.19	0.95	0.83	0.62
350	1.44	1.23	0.99	0.86	0.65
400	1.54	1.32	1.06	0.91	0.70
450	1.64	1.40	1.13	0.97	0.74
500	1.72	1.48	1.19	1.03	0.78
550	1.81	1.55	1.25	1.08	0.82
600	1.90	1.63	1.34	1.11	0.87
750	2.13	1.83	1.50	1.25	0.97
800	2.22	1.91	1.56	1.30	1.02
900	2.36	2.03	1.67	1.39	1.09
1000	2.49	2.15	1.77	1.47	1.16
1100	N/A	2.26	N/A	1.55	N/A
1200	N/A	2.37	N/A	1.64	N/A
1300	N/A	2.48	N/A	1.73	N/A
1400	N/A	2.57	N/A	1.78	N/A
1500	N/A	2.66	N/A	1.84	N/A
1600	N/A	2.77	N/A	1.97	N/A
1700	N/A	2.86	N/A	2.04	N/A
1800	N/A	2.95	N/A	2.10	N/A
1900	N/A	3.03	N/A	2.13	N/A
2000	N/A	3.14	N/A	2.20	N/A
2100	N/A	3.20	N/A	2.26	N/A
2200	N/A	3.29	N/A	2.33	N/A
2300	N/A	3.37	N/A	2.40	N/A
2400	N/A	3.46	N/A	2.46	N/A
2500	N/A	3.56	N/A	2.52	N/A
2600	N/A	3.63	N/A	2.58	N/A
2700	N/A	3.71	N/A	2.64	N/A
2800	N/A	3.82	N/A	2.71	N/A
2900	N/A	3.92	N/A	2.78	N/A
3000	N/A	4.02	N/A	2.85	N/A

Loop resistance at 68 °F (ohms/1000 ft)<sup>2</sup>

<b>Copper-Clad Aluminum</b>	2.04	1.57	1.01	0.73	0.41
<b>Solid Copper</b>	—	—	—	—	—

Contact manufacturer for latest information.

- 1 To obtain loss in dB/100 m, multiply by 3.281.
- 2 To obtain resistance in ohms/1000 m, multiply by 3.281.

## 2.10 Comm/Scope Drop Cable

Frequency (MHz)	Series			
	59 foam	6 foam	7 foam	11 foam
5	0.86	0.58	0.47	0.38
55	2.05	1.18	0.92	0.96
83	2.45	1.95	1.06	1.18
187	3.60	2.85	1.19	1.75
204	N/A	3.00	N/A	1.87
211	3.80	3.05	1.73	1.90
250	4.10	3.30	2.14	2.05
300	4.45	3.55	2.82	2.25
350	4.80	3.85	3.05	2.42
400	5.10	4.15	3.27	2.60
450	5.40	4.40	3.46	2.75
500	5.70	4.66	N/A	2.90
550	5.95	4.90	3.85	3.04
600	6.20	5.10	4.05	3.18
750	6.97	5.65	4.57	3.65
865	7.52	6.10	4.93	3.98
1000	8.12	6.55	5.32	4.35
1218	N/A	7.21	N/A	4.92

Maximum loss at 68 °F (dB/100 ft); to obtain loss in dB/100 m, multiply by 3.281.

## 2.11 Tilt vs Cable Chart

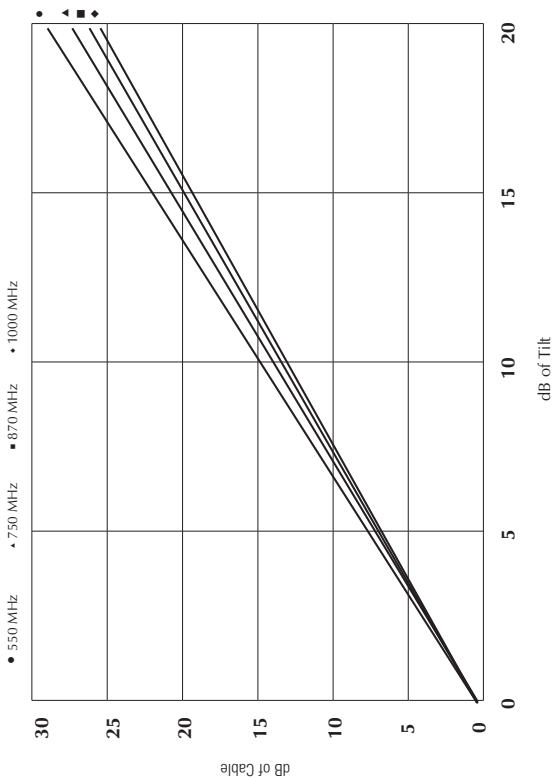

## 2.12 Cable and Equalizer Formulas

### 2.12.1 Cable Loss Ratio

The ratio of cable attenuation at two frequencies is approximately equal to the square root of the ratio of the two frequencies. See Section 2.9, Tilt vs Cable chart.

$$\text{Cable loss ratio} = \sqrt{\frac{f1}{f2}}$$

Example:

Approximate the cable loss at 55 MHz when the loss at 450 MHz is 20 dB. Attenuation at 55 MHz =  $20\sqrt{\frac{55}{450}} = 6.99 \text{ dB}$

### 2.12.2 Tilt to Cable Loss

To convert tilt (differential in signal level between end frequencies of the cable bandpass) to cable loss at the higher frequency:

$$\text{dB of cable} = \frac{\text{tilt}(dB)}{1 - \sqrt{\frac{f1}{f2}}}$$

Example:

Calculate the cable loss at 450 MHz when the tilt is 12 dB between 55 MHz and 450 MHz.

$$\text{dB of cable} = \frac{12}{1 - \sqrt{\frac{55}{450}}} = 18.45 \text{ dB}$$

### 2.12.3 Equalizer Loss

To calculate equalizer loss at any frequency:

$$\text{Loss at } f1 = \text{EqValue} - \left[ \text{EqValue} \sqrt{\frac{f1}{f2}} - 1 \right]$$



Example:

Calculate the loss at 55 MHz of an equalizer for 20 dB of cable at 450 MHz.

$$\text{Loss at 55 MHz} = 20 - \left[ (20 \sqrt{\frac{55}{450}}) - 1 \right] = 14.01 \text{ dB}$$

#### 2.12.4 Cable Attenuation vs Temperature

Cable attenuation at temperature (t) is given by:

$$\text{Attenuation at } ^\circ\text{F} = \text{Att at } 68 ^\circ\text{F} * [1 + 0.0011(t - 68)]$$

$$\text{Attenuation at } ^\circ\text{C} = \text{Att at } 20 ^\circ\text{C} * [1 + 0.002(t - 20)]$$

Example:

Calculate the loss at  $-20 ^\circ\text{F}$  when the attenuation at  $68 ^\circ\text{F}$  is 20 dB.

$$\text{Att at } -20 ^\circ\text{F} = \text{Att at } 68 ^\circ\text{F} * 20[1 + 0.0011(-20 - 68)] = 18.06 \text{ dB}$$

#### 2.12.5 Loop Resistance vs Temperature

Cable loop resistance (R) at temperature (t) is given by:

$$R \text{ at } ^\circ\text{F} = R \text{ at } 68 ^\circ\text{F} * [1 + 0.0022(t - 68)]$$

$$R \text{ at } ^\circ\text{C} = R \text{ at } 20 ^\circ\text{C} * [1 + 0.004(t - 20)]$$

Example:

Calculate the loop resistance at  $120 ^\circ\text{F}$  when the resistance at  $68 ^\circ\text{F}$  is 3 ohms.

$$R \text{ at } 120 ^\circ\text{F} = 3[1 + 0.0022(120 - 68)] = 3.34 \text{ ohms}$$

## 2.13 HRC Channel Plan

Channels T-7 through T-13 are return channels. These channels were originally used as forward channels in sub-low supertrunks. When block upconverted, they could easily be changed to VHF channels 7–13.

### Harmonically Related Carriers

Channel Number/ Letter	Channel Bandedge (MHz)	Visual Carrier (MHz)	Chroma Carrier (MHz)	Aural Carrier (MHz)
T-7	–	–	–	–
T-8	–	–	–	–
T-9	–	–	–	–
T-10	–	–	–	–
T-11	–	–	–	–
T-12	–	–	–	–
T-13	–	–	–	–
2	52.7527 – 58.7527	54.0027	57.5822	58.5027
3	58.7530 – 64.7530	60.0030	63.5825	64.503
4	64.7533 – 70.7533	66.0033	69.5828	70.5033
A-8	70.7536 – 76.7536	72.0036	75.5831	76.5036
5	76.7539 – 82.7539	78.0039	81.5834	82.5039
6	82.7542 – 88.7542	84.0042	87.5837	88.5042
95	A-5 88.7545 – 94.7545	90.0045	93.5840	94.5045
96	A-4 94.7548 – 100.7548	96.0048	99.5843	100.5048
97	A-3 100.7551 – 106.7551	102.0051	105.5846	106.5051
98	A-2	Cannot lock to comb reference		
99	A-1	Refer to FCC regulations		
14	A 118.7560 – 124.7560	120.0060	123.5855	124.5060
15	B 124.7563 – 130.7563	126.0063	129.5858	130.5063
16	C 130.7566 – 136.7566	132.0066	135.5861	136.5066
17	D 136.7569 – 142.7569	138.0069	141.5864	142.5069
18	E 142.7572 – 148.7572	144.0072	147.5867	148.5072
19	F 148.7575 – 154.7575	150.0075	153.5870	154.5075
20	G 154.7578 – 160.7578	156.0078	159.5873	160.5078
21	H 160.7581 – 166.7581	162.0081	165.5876	166.5081
22	I 166.7584 – 172.7584	168.0084	171.5879	172.5084
7	172.7587 – 178.7587	174.0087	177.5882	178.5087
8	178.7590 – 184.7590	180.0090	183.5885	184.5090
9	184.7593 – 190.7593	186.0093	189.5888	190.5093
10	190.7596 – 196.7596	192.0096	195.5891	196.5096
11	196.7599 – 202.7599	198.0099	201.5894	202.5099
12	202.7602 – 208.7602	204.0102	207.5897	208.5102
13	208.7605 – 214.7605	210.0105	213.5900	214.5105
23	J 214.7608 – 220.7608	216.0108	219.5903	220.5108
24	K 220.7611 – 226.7611	222.0111	225.5906	226.5111

## Harmonically Related Carriers (cont'd)

Channel Number/ Letter	Channel Bandedge (MHz)	Visual Carrier (MHz)	Chroma Carrier (MHz)	Aural Carrier (MHz)
25 L	226.7614 – 232.7614	228.0114	231.5909	232.5114
26 M	232.7617 – 238.7617	234.0117	237.5912	238.5117
27 N	238.7620 – 244.7620	240.0120	243.5915	244.5120
28 O	244.7623 – 250.7623	246.0123	249.5918	250.5123
29 P	250.7626 – 256.7626	252.0126	255.5921	256.5126
30 Q	256.7629 – 262.7629	258.0129	261.5924	262.5129
31 R	262.7632 – 268.7632	264.0132	267.5927	268.5132
32 S	268.7635 – 274.7635	270.0135	273.5930	274.5135
33 T	274.7638 – 280.7638	276.0138	279.5933	280.5138
34 U	280.7641 – 286.7641	282.0141	285.5936	286.5141
35 V	286.7644 – 292.7644	288.0144	291.5939	292.5144
36 W	292.7647 – 298.7647	294.0147	297.5942	298.5147
37 AA	298.7650 – 304.7650	300.0150	303.5945	304.5150
38 BB	304.7653 – 310.7653	306.0153	309.5948	310.5153
39 CC	310.7656 – 316.7656	312.0156	315.5951	316.5156
40 DD	316.7659 – 322.7659	318.0159	321.5954	322.5159
41 EE	322.7662 – 328.7662	324.0162	327.5957	328.5162
42 FF	328.7665 – 334.7665	330.0165	333.5960	334.5165
43 GG	334.7668 – 340.7668	336.0168	339.5963	340.5168
44 HH	340.7671 – 346.7671	342.0171	345.5966	346.5171
45 II	346.7674 – 352.7674	348.0174	351.5969	352.5174
46 JJ	352.7677 – 358.7677	354.0177	357.5972	358.5177
47 KK	358.7680 – 364.7680	360.0180	363.5975	364.5180
48 LL	364.7683 – 370.7683	366.0183	369.5978	370.5183
49 MM	370.7686 – 376.7686	372.0186	375.5981	376.5186
50 NN	376.7689 – 382.7689	378.0189	381.5984	382.5189
51 OO	382.7692 – 388.7692	384.0192	387.5987	388.5192
52 PP	388.7695 – 394.7695	390.0195	393.5990	394.5195
53 QQ	394.7698 – 400.7698	396.0198	399.5993	400.5198
54 RR	400.7701 – 406.7701	402.0201	405.5996	406.5201
55 SS	406.7704 – 412.7704	408.0204	411.5999	412.5204
56 TT	412.7707 – 418.7707	414.0207	417.6002	418.5207
57 UU	418.7710 – 424.7710	420.0210	423.6005	424.5210
58 VV	424.7713 – 430.7713	426.0213	429.6008	430.5213
59 WW	430.7716 – 436.7716	432.0216	435.6011	436.5216
60 XX	436.7719 – 442.7719	438.0219	441.6014	442.5219
61 YY	442.7722 – 448.7722	444.0222	447.6017	448.5222
62 ZZ	448.7725 – 454.7725	450.0225	453.6020	454.5225
63	454.7728 – 460.7728	456.0228	459.6023	460.5228
64	460.7731 – 466.7731	462.0231	465.6026	466.5231
65	466.7734 – 472.7734	468.0234	471.6029	472.5234
66	472.7737 – 478.7737	474.0237	477.6032	478.5237
67	478.7740 – 484.7740	480.0240	483.6035	484.5240

## Harmonically Related Carriers (cont'd)

Channel Number/ Letter	Channel Bandedge (MHz)	Visual Carrier (MHz)	Chroma Carrier (MHz)	Aural Carrier (MHz)
68	484.7743 – 490.7743	486.0243	489.6038	490.5243
69	490.7746 – 496.7746	492.0246	495.6041	496.5246
70	496.7749 – 502.7749	498.0249	501.6044	502.5249
71	502.7752 – 508.7752	504.0252	507.6047	508.5252
72	508.7755 – 514.7755	510.0255	513.6050	514.5255
73	514.7758 – 520.7758	516.0258	519.6053	520.5258
74	520.7761 – 526.7761	522.0261	525.6056	526.5261
75	526.7764 – 532.7764	528.0264	531.6059	532.5264
76	532.7767 – 538.7767	534.0267	537.6062	538.5267
77	538.7770 – 544.7770	540.0270	543.6065	544.5270
78	544.7773 – 550.7773	546.0273	549.6068	550.5273
79	550.7776 – 556.7776	552.0276	555.6071	556.5276
80	556.7779 – 562.7779	558.0279	561.6074	562.5279
81	562.7782 – 568.7782	564.0282	567.6077	568.5282
82	568.7785 – 574.7785	570.0285	573.6080	574.5285
83	574.7788 – 580.7788	576.0288	579.6083	580.5288
84	580.7791 – 586.7791	582.0291	585.6086	586.5291
85	586.7794 – 592.7794	588.0294	591.6089	592.5294
86	592.7797 – 598.7797	594.0297	597.6092	598.5297
87	598.7800 – 604.7800	600.0300	603.6095	604.5300
88	604.7803 – 610.7803	606.0303	609.6098	610.5303
89	610.7806 – 616.7806	612.0306	615.6101	616.5306
90	616.7809 – 622.7809	618.0309	621.6104	622.5309
91	622.7812 – 628.7812	624.0312	627.6107	628.5312
92	628.7815 – 634.7815	630.0315	633.6110	634.5315
93	634.7818 – 640.7818	636.0318	639.6113	640.5318
94	640.7821 – 646.7821	642.0321	645.6116	646.5321
100	646.7824 – 652.7824	648.0324	651.6119	652.5324
101	652.7827 – 658.7827	654.0327	657.6122	658.5327
102	658.7830 – 664.7830	660.0330	663.6125	664.5330
103	664.7833 – 670.7833	666.0333	669.6128	670.5333
104	670.7836 – 676.7836	672.0336	675.6131	676.5336
105	676.7839 – 682.7839	678.0339	681.6134	682.5339
106	682.7842 – 688.7842	684.0342	687.6137	688.5342
107	688.7845 – 694.7845	690.0345	693.6140	694.5345
108	694.7848 – 700.7848	696.0348	699.6143	700.5348
109	700.7851 – 706.7851	702.0351	705.6146	706.5351
110	706.7854 – 712.7854	708.0354	711.6149	712.5354
111	712.7857 – 718.7857	714.0357	717.6152	718.5357
112	718.7860 – 724.7860	720.0360	723.6155	724.5360
113	724.7863 – 730.7863	726.0363	729.6158	730.5363
114	730.7866 – 736.7866	732.0366	735.6161	736.5366
115	736.7869 – 742.7869	738.0369	741.6164	742.5369

## Harmonically Related Carriers (cont'd)

Channel Number/ Letter	Channel Bandedge (MHz)	Visual Carrier (MHz)	Chroma Carrier (MHz)	Aural Carrier (MHz)
116	742.7872 – 748.7872	744.0372	747.6167	748.5372
117	748.7875 – 754.7875	750.0375	753.6170	754.5375
118	754.7878 – 760.7878	756.0378	759.6173	760.5378
119	760.7881 – 766.7881	762.0381	765.6176	766.5381
120	766.7884 – 772.7884	768.0384	771.6179	772.5384
121	772.7887 – 778.7887	774.0387	777.6182	778.5387
122	778.7890 – 784.7890	780.0390	783.6185	784.5390
123	784.7893 – 790.7893	786.0393	789.6188	790.5393
124	790.7896 – 796.7896	792.0396	795.6191	796.5396
125	796.7899 – 802.7899	798.0399	801.6194	802.5399

### 2.14 CTA Channel Nomenclature

The frequencies shown in the FCC Frequency Allocation table starting on page 2-2 for the visual carrier are the CTA Standard (STD) frequencies. CTA also defines incrementally related coherent (IRC) frequencies and the harmonically related coherent (HRC) frequencies. With the exception of channels 98 (A-2) and 99(A-1), which are identical, the IRC visual carrier frequencies are similar to the STD frequencies except that they all end in .2625MHz and thus are all exactly 6MHz apart. In HRC systems, all carriers are at harmonics of 6.0003MHz. Finally, the center frequency of downstream DOCSIS® QAM signals is 1.75MHz higher than the visual carrier frequency in the chart.

## 2.15 VHF and UHF Channel Plan

### Over-the-air VHF TV Channels

Channel Number	Channel Bandedge (MHz)		Visual Carrier (MHz)	DTV Carrier (MHz)	Aural Carrier (MHz)
2	54	60	55.25	54.31	59.75
3	60	66	61.25	60.31	65.75
4	66	72	67.25	66.31	71.75
5	76	82	77.25	76.31	81.75
6	82	88	83.25	82.31	87.75
7	174	180	175.25	174.31	179.75
8	180	186	181.25	180.31	185.75
9	186	192	187.25	186.31	191.75
10	192	198	193.25	192.31	197.75
11	198	204	199.25	198.31	203.75
12	204	210	205.25	204.31	209.75
13	210	216	211.25	210.31	215.75

### Over-the-air UHF TV Channels

Channel Number	Channel Bandedge (MHz)		Visual Carrier (MHz)	Chroma Carrier (MHz)	Aural Carrier (MHz)
14	470	476	471.25	474.83	475.75
15	476	482	477.25	480.83	481.75
16	482	488	483.25	486.83	487.75
17	488	494	489.25	492.83	493.75
18	494	500	495.25	498.83	499.75
19	500	506	501.25	504.83	505.75
20	506	512	507.25	510.83	511.75
21	512	518	513.25	516.83	517.75
22	518	524	519.25	522.83	523.75
23	524	530	525.25	528.83	529.75
24	530	536	531.25	534.83	535.75
25	536	542	537.25	540.83	541.75
26	542	548	543.25	546.83	547.75
27	548	554	549.25	552.83	553.75
28	554	560	555.25	558.83	559.75
29	560	566	561.25	564.83	565.75
30	566	572	567.25	570.83	571.75
31	572	578	573.25	576.83	577.75
32	578	584	579.25	582.83	583.75
33	584	590	585.25	588.83	589.75
34	590	596	591.25	594.83	595.75
35	596	602	597.25	600.83	601.75

## Over-the-air UHF TV Channels (cont'd)

Channel Number	Channel Bandedge (MHz)		Visual Carrier (MHz)	Chroma Carrier (MHz)	Aural Carrier (MHz)
36	602	608	603.25	606.83	607.75
37	608	614	609.25	612.83	613.75
38	614	620	615.25	618.83	619.75
39	620	626	621.25	624.83	625.75
40	626	632	627.25	630.83	631.75
41	632	638	633.25	636.83	637.75
42	638	644	639.25	642.83	643.75
43	644	650	645.25	648.83	649.75
44	650	656	651.25	654.83	655.75
45	656	662	657.25	660.83	661.75
46	662	668	663.25	666.83	667.75
47	668	674	669.25	672.83	673.75
48	674	680	675.25	678.83	679.75
49	680	686	681.25	684.83	685.75
50	686	692	687.25	690.83	691.75
51	692	698	693.25	696.83	697.75
The FCC has reallocated channels 52 through 83 for other services.					

## 2.16 QAM Channel Center Frequencies

CTA CH.	Center Freq. (MHz)	CTA CH.	Center Freq. (MHz)	CTA CH.	Center Freq. (MHz)	CTA CH.	Center Freq. (MHz)	CTA CH.	Center Freq. (MHz)
2	57	29	255	61	447	93	639	130	831
3	63	30	261	62	453	94	645	131	837
4	69	31	267	63	459	100	651	132	843
5	79	32	273	64	465	101	657	133	849
6	85	33	279	65	471	102	663	134	855
95	93	34	285	66	477	103	669	135	861
96	99	35	291	67	483	104	675	136	867
97	105	36	297	68	489	105	681	137	873
98	111	37	303	69	495	106	687	138	879
99	117	38	309	70	501	107	693	139	885
14	123	39	315	71	507	108	699	140	891
15	129	40	321	72	513	109	705	141	897
16	135	41	327	73	519	110	711	142	903
17	141	42	333	74	525	111	717	143	909
18	147	43	339	75	531	112	723	144	915
19	153	44	345	76	537	113	729	145	921
20	159	45	351	77	543	114	735	146	927
21	165	46	357	78	549	115	741	147	933
22	171	47	363	79	555	116	747	148	939
7	177	48	369	80	561	117	753	149	945
8	183	49	375	81	567	118	759	150	951
9	189	50	381	82	573	119	765	151	957
10	195	51	387	83	579	120	771	152	963
11	201	52	393	84	585	121	777	153	969
12	207	53	399	85	591	122	783	154	975
13	213	54	405	86	597	123	789	155	981
23	219	55	411	87	603	124	795	156	987
24	225	56	417	88	609	125	801	157	993
25	231	57	423	89	615	126	807	158	999
26	237	58	429	90	621	127	813		
27	243	59	435	91	627	128	819		
28	249	60	441	92	633	129	825		



## 2.17 FCC Rules and Regulations, Part 76

This section is a summary of FCC specifications that CATV systems are required to meet.



**Note:** *The intention of this section is to summarize FCC specifications, not to replace them. Consult the current editions of all specifications and regulations for the complete and detailed requirements. (Refer to [www.fcc.gov](http://www.fcc.gov)).*

---

Title 47 Telecommunications, part 76.640 references the technical requirements for unidirectional digital cable products on digital cable systems.

All specifications in this handbook were taken from Title 47 Telecommunications, part 76.605 from the FCC. It summarizes the rule, standard, number of channels to be tested, frequency of testing, and equipment needed to perform each test. (It should be noted that although testing is required on a limited number of channels, all channels must conform to the specifications.)

From the FCC specifications Title 47 Telecommunications, part 76.601: “For cable television systems with 1,000 or more subscribers, but with 12,500 or less subscribers, proof-of-performance tests conducted pursuant to this section shall include measurements taken at six (6) widely separated points. However, within each cable system, one additional test point shall be added for every additional 12,500 subscribers or fraction thereof...chosen...to represent all geographic areas served...at least one-third...representative of subscriber terminals most distant...”

The headings/titles given to these rules are not those of the FCC. They are supplied here to help quickly identify what is covered by each rule.

<b>Rule 76.605 (a)(2)</b>	<b>Aural Carrier Frequency</b>
Standard	4.5MHz $\pm$ 5kHz above the visual carrier, at the output of the modulating or processing equipment and at the subscriber terminal
Number of Channels	Seven, plus one channel for every 100MHz, or fraction thereof, of upper band limit above 400MHz <i>Ex: 10 channels for a 650MHz system</i>
Frequency of Testing	Two times per year
Type of Equipment	Spectrum analyzer, frequency counter, or automated testing system

<b>Rule 76.605 (a)(3)</b>	<b>Visual Carrier Frequency</b>
Standard	0dBmV at subscriber terminal and 3.0dBmV at end of 100 ft. drop cable connected to the subscriber tap
Number of Channels	All NTSC or similar video channels
Frequency of Testing	Two times per year
Type of Equipment	SLM, system analyzer, spectrum analyzer, or automated test system

<b>Rule 76.605 (a)(4)</b>	<b>24-Hour Visual Signal Level Variance Test</b>
Standard	Level on each channel not to vary more than 8dB within any 6-month interval including all tests in the 24-hour test period (measured at end of 100 ft. drop cable connected to the subscriber tap)
Number of Channels	All NTSC or similar video channels
Frequency of Testing	In July/August and January/February, one test per channel every six hours for a 24-hour period
Type of Equipment	SLM, system analyzer, spectrum analyzer, or automated test system

<b>Rule 76.605 (a)(4)(i)</b>	<b>Adjacent Visual Carrier Level Variation</b>
Standard	Within 3dB of any adjacent visual carrier within 6MHz
Number of Channels	All NTSC or similar video channels
Frequency of Testing	In July/August and January/February, one test each channel every six hours for a 24-hour test period
Type of Equipment	SLM, system analyzer, spectrum analyzer, or automated test system

<b>Rule 76.605 (a)(4)(ii)</b>	<b>Visual Carrier Level Variation Over Entire Bandwidth</b>
Standard	Within 10dB of the visual signal on any other channel for a system with an upper band limit of 300MHz, with a 1 dB increase for each additional 100MHz of upper band limit: <i>Ex: 12dB for a 401-500MHz system; 13dB for a 501-600MHz system, etc.</i>
Number of Channels	All NTSC or similar video channels
Frequency of Testing	In July/August and January/February, one test each channel every six hours for a 24-hour test period
Type of Equipment	SLM, system analyzer, spectrum analyzer, or automated test system

<b>Rule 76.605 (a)(4)(iii)</b>	<b>Maximum Visual Carrier Level</b>
Standard	Carrier level that will not overload the subscriber's terminal or receiver
Number of Channels	All NTSC or similar video channels
Frequency of Testing	In July/August and January/February, one test each channel every six hours for each 24-hour test period
Type of Equipment	SLM, system analyzer, spectrum analyzer, or automated test system

<b>Rule 76.605 (a)(5)</b>	<b>Aural Signal Level</b>
Standard	At both the subscriber terminal and the headend output: 10 to 17 dB below the associated visual signal level. At a baseband converter: 6.5 to 17 dB below the associated visual signal level
Number of Channels	All NTSC or similar video channels
Frequency of Testing	Two times per year
Type of Equipment	SLM, system analyzer, spectrum analyzer, or automated test system

<b>Rule 76.605 (a)(6)</b>	<b>In-Band Frequency Response</b>
Standard	Within a range of $\pm 2$ dB in the band from 0.75 to 5.0 MHz above the channel lower boundary, at the subscriber terminal
Number of Channels	Seven, plus one channel for every 100 MHz, or fraction thereof, upper band limit above 400 MHz <i>Ex: 11 channels for a 750 MHz system</i>
Frequency of Testing	Two times per year
Type of Equipment	Sweep transmitter/receiver, spectrum analyzer, or automated test system

<b>Rule 76.605 (a)(7)</b>	<b>Visual Carrier to Noise Ratio (CNR)<sup>1</sup></b>
Standard	CNR shall not be less than 43 dB
Number of Channels	Seven, plus one channel for every 100 MHz, or fraction thereof, upper band limit above 400 MHz <i>Ex: 12 channels for an 862 MHz system</i>
Frequency of Testing	Two times per year
Type of Equipment	SLM, system analyzer, spectrum analyzer, or automated test system

1. For more information on CNR, see Section 3.2.1 on page 3-7.

<b>Rule 76.605 (a)(8)</b>	<b>Carrier to Coherent Beats</b>
Standard	Not less than 51 dB for non-coherent (standard) CATV systems, or not less than 47 dB for coherent (HRC/IRC) CATV systems
Number of Channels	Seven, plus one channel for every 100MHz, or fraction thereof, upper band limit above 400MHz <i>Ex: 10 channels for a 650MHz system</i>
Frequency of Testing	Two times per year
Type of Equipment	SLM, system analyzer, spectrum analyzer, or automated test system

<b>Rule 76.605 (a)(9)</b>	<b>Terminal Isolation</b>
Standard	Not less than 18dB (or manufacturer's specification) and sufficient to prevent subscriber-caused terminal reflections
Number of Channels	Seven, plus one channel for every 100MHz, or fraction thereof, upper band limit above 400MHz <i>Ex: 12 channels for an 862MHz system</i>
Frequency of Testing	Two times per year
Type of Equipment	Manufacturer's specifications

<b>Rule 76.605 (a)(10)</b>	<b>Hum Modulation</b>
Standard	Not to exceed 3% of visual signal level
Number of Channels	One unmodulated channel
Frequency of Testing	Two times per year
Type of Equipment	SLM, system analyzer, spectrum analyzer, or automated test system

<b>Rule 76.605(a)(11)(i)</b>	<b>Chrominance Luminance Delay</b>
Standard	Within 170 ns
Number of Channels	Seven, plus one channel for every 100MHz, or fraction thereof, upper band limit above 400MHz <i>Ex: 9 channels for a 550MHz system</i>
Frequency of Testing	Once every three years (at headend)
Type of Equipment	Vectorscope, waveform monitor, or automated test system

<b>Rule 76.605(a)(11)(ii)</b>	<b>Differential Gain</b>
Standard	Not to exceed $\pm 20\%$ of the maximum
Number of Channels	Seven, plus one channel for every 100MHz, or fraction thereof, upper band limit above 400MHz <i>Ex: 10 channels for a 650MHz system</i>
Frequency of Testing	Once every three years (at headend)
Type of Equipment	Vectorscope, waveform monitor, or automated test system

<b>Rule 76.605(a)(11)(iii)</b>	<b>Differential Phase</b>
Standard	Not to exceed $\pm 10^\circ$
Number of Channels	Seven, plus one channel for every 100MHz, or fraction thereof, upper band limit above 400MHz <i>Ex: 11 channels for a 750MHz system</i>
Frequency of Testing	Once every three years (at headend)
Type of Equipment	Vectorscope, waveform monitor, or automated test system

<b>Rule 76.605 (a)(12)</b>	<b>RF Signal Leakage Index (CLI)<sup>1</sup> Limit</b>
Standard	< 54MHz and > 216MHz: $15\mu\text{V/m}$ @ 30m; 54 to 216MHz: $20\mu\text{V/m}$ @ 3m
Frequency of Testing	Quarterly
Type of Equipment	SLM, system analyzer, or spectrum analyzer and dipole, leakage field strength meter

1. For more information on CLI, see Section 4.1 on page 4-2.

## 2.18 Performance Standards

This is a summary of the FCC Proof of Performance Standards and is not intended as a replacement for those standards. Refer to the current edition of the FCC rules and regulations for definitive requirements (Title 47 Telecommunications Act, part 76.605).

Parameter	FCC Standard
Visual Signal at Subscriber Terminal	$\geq 0$ dBmV and $\geq 3.0$ dBmV @ 100' Drop
CNR at Subscriber Terminal	$\geq 43$ dB
CTB at Subscriber Terminal	$\geq 51$ dB
CSO at Subscriber Terminal	$\geq 51$ dB
3 IM at Subscriber Terminal	$\geq 51$ dB
2 IM at Subscriber Terminal	$\geq 51$ dB
Hum Distortion (Incidental Modulation)	$\leq 3\%$
Signal Leakage	
$\leq 54$ MHz	15 $\mu$ V/m@30m
54 to 216 MHz	20 $\mu$ V/m@3m
$> 216$ MHz	15 $\mu$ V/m@30m
Freq Response (Peak to Valley)	
4.2 MHz	$\pm 2$ dB
Total Signal Level Variation over Entire Frequency Range	$\leq 10$ dB over 300 MHz +1 dB per each additional 100 MHz <i>Ex: <math>\leq 15</math> dB over 750 MHz</i>
Isolation Port to Port	18 dB

## 2.19 MoCA Frequency Allocation

The Multimedia over Coax Alliance (MoCA) networking standard is used by cable, satellite, and IPTV set tops for communications between devices to permit for example multi-room digital video recording (DVR) functionality using a master or gateway set top box (STB) and less capable client STBs. The lowest frequency band was added in the MoCA 1.1 Annex to permit DBS equipment to communicate without overlap with 0.95 - 2.15GHz band used between satellite dish and receiver. MoCA uses orthogonal frequency-division multiplexing (OFDM) which is a multi-tone modulation scheme. MoCA 2.0 offers two performance modes, Basic and Enhanced which give effective throughputs of 400 and 800Mbps, respectively, and modulation rates which are 1.75 times the effective throughput. The MoCA frequency ranges are:

500kHz - 1.5MHz	(MoCA 1.1 Annex)
850 - 1500MHz	(MoCA 1.0)
500 - 1500MHz	(MoCA 1.1 Annex)
500kHz - 1.5MHz, 500 - 1650MHz	(MoCA 2.0)

## 2.20 WiFi RF Band Assignments (US)

Standard	802.11	802.11a	802.11b	802.11g	802.11n
<b>Freq. Band(s) (MHz)</b>	2400 – 2483.5	5150 – 5250, 5250 – 5350, 5725 – 5825	2400 – 2483.5	2400 – 2483.5	All a/b/g bands

## 2.21 WiMAX RF Band Assignment (US Typical)

While the 802.16 WiMAX standards cover 2 – 66GHz, current US deployments use 2.3, 2.5, 3.65, and 5.8GHz since frequencies below 6GHz are best for non line-of-sight RF.



## 2.22 Frequency Allocation Chart

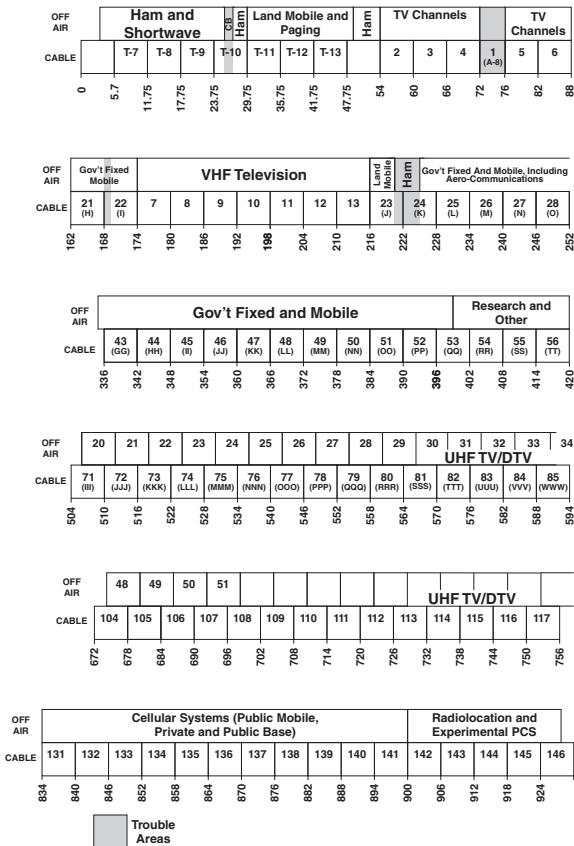

FM			Aircraft Radio, Voice and Aeronavigation				Space Research	Ham	Land Mobile				
95 (A-5)	96 (A-4)	97 (A-3)	98 (A-2)	99 (A-1)	14 (A)	15 (B)	16 (C)	17 (D)	18 (E)	19 (F)	20 (G)		
88	90	96	102	108	114	120	126	132	138	144	150	156	162

Gov't Fixed And Mobile, Including Aero-Communications							Harbor Navigation and Coast Guard							
29 (P)	30 (O)	31 (R)	32 (S)	33 (T)	34 (U)	35 (V)	36 (W)	37 (AA)	38 (BB)	39 (CC)	40 (DD)	41 (EE)	42 (FF)	
252	258	264	270	276	282	288	294	300	306	312	318	324	330	336

Ham					Land Mobile			UHF TV/DTV						
57 (UU)	58 (VV)	59 (WW)	60 (XX)	61 (YY)	62 (ZZ)	63 (AAA)	64 (BBB)	65 (CCC)	66 (DDD)	67 (EEE)	68 (FFF)	69 (GGG)	70 (HHH)	
420	426	432	438	444	450	456	462	468	474	480	486	492	498	504

34	35	36	37	38	39	40	41	42	43	44	45	46	47
UHF TV/DTV													
86 (XXX)	87 (YYY)	88 (ZZZ)	89	90	91	92	93	94	100	101	102	103	
594	600	606	612	618	624	630	636	642	648	654	660	666	672

UHF TV/DTV										Cellular Systems (Public Mobile, Private and Public Base)			
118	119	120	121	122	123	124	125	126	127	128	129	130	
756	762	768	774	780	786	792	798	804	810	816	822	828	834

Paging Sys.	Land Mobile Non-Common Carrier		Private Fixed		Aircraft Radionavigation							
147	148	149	150	151	152	153	154	155	156	157	158	
930	936	942	948	954	960	966	972	978	984	990	996	1002

 Trouble Areas

# RF Calculations

$$F_x = L_{F_H} - \frac{T}{B} (F_H - F_x)$$

$$R_S = (-10) \log \left[ 10^{\frac{-CNR_1}{10}} + 10^{\frac{-CNR_2}{10}} \right]$$

$$L_{F_x} = L_{F_H} - \frac{T}{B} (F_H - F_x)$$

### 3.1 Determining Carrier Levels

Determine balancing carrier levels by: Formula, Tilt Charts, and Calculation Chart.

#### 3.1.1 Formula

Use the following formula to find the carrier output level (**L**) at a frequency (**F<sub>x</sub>**), that is not a bandedge frequency

$$L_{F_x} = L_{F_H} - \frac{T}{B}(F_H - F_x)$$

where:

**L<sub>F<sub>x</sub></sub>** = Level at the balancing carrier frequency (dB)

**L<sub>F<sub>H</sub></sub>** = Level at the high bandedge frequency (dB)

**T** = System tilt (dB)

**B** = Band pass of the system (MHz)

**F<sub>H</sub>** = High bandedge frequency (MHz)

**F<sub>x</sub>** = Balancing carrier frequency (MHz)

#### 3.1.2 Tilt Chart

Determine the balancing carrier level using one of the following Tilt Charts. (Use the chart with the highest frequency matching that of your system—750MHz, 862MHz, or 1002MHz.) Typical system tilts are shown on each chart. (If your system tilt is not on the chart, adapt the chart or use the blank chart on page 3-6.)

Use a straightedge to draw a line from the upper right-hand corner of the chart to the point on the left hand side of the chart that corresponds to your system tilt and lowest forward frequency.

##### ► To use the chart

1. Find the point where the tilt line crosses the desired frequency.
2. From this point, read across to the dB level on the vertical axis.
3. Subtract the dB level on the vertical axis from the highest frequency output level to obtain the correct output level at the desired frequency.

# Amplifier Tilt—750MHz

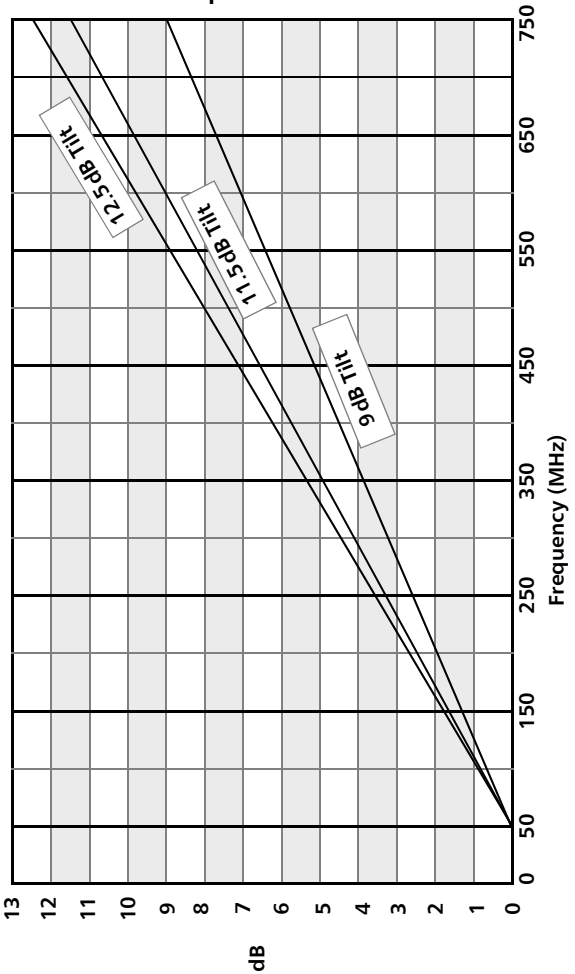

# Amplifier Tilt—870MHz

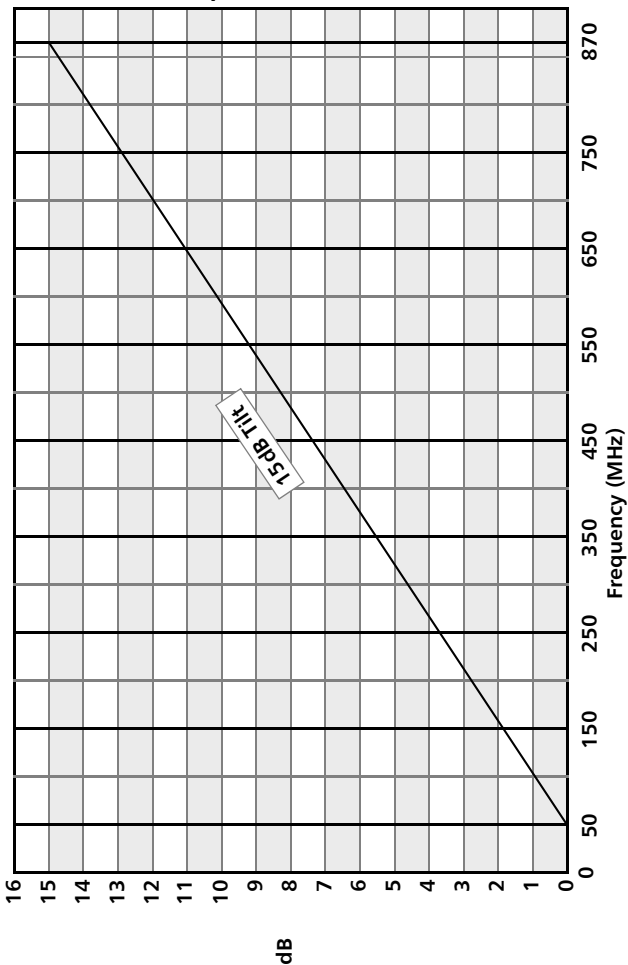

# Amplifier Tilt—1002MHz

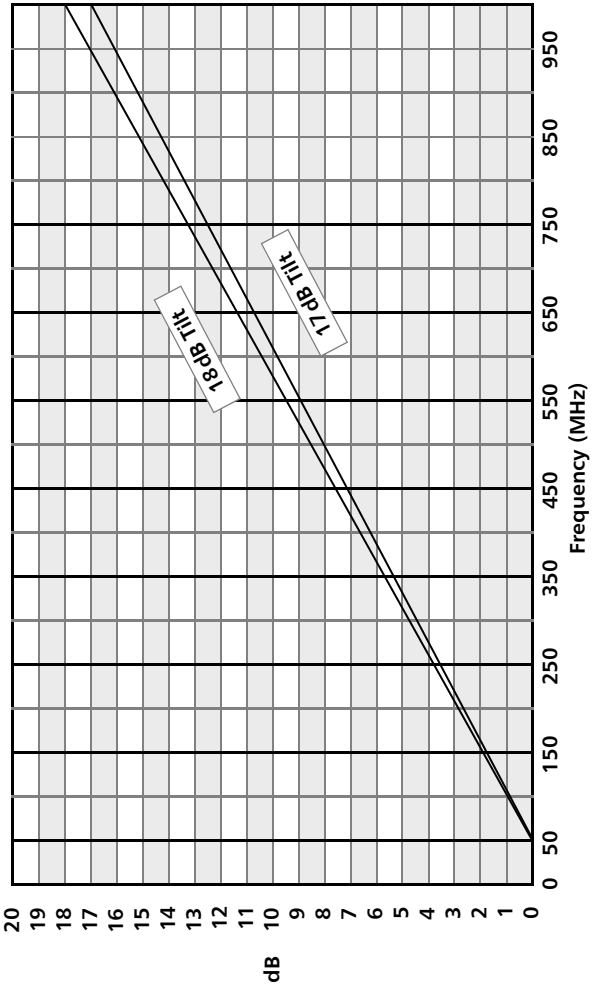

# Amplifier Tilt Worksheet

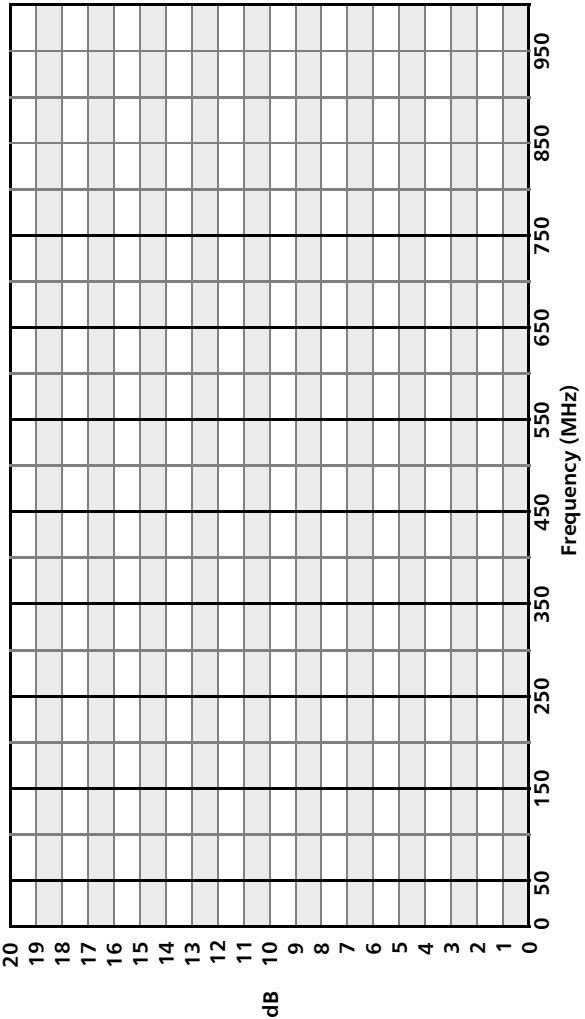



## 3.2 System Performance Equations

### 3.2.1 Carrier to Noise Ratio (CNR) for NTSC Channels

CNR is a measurement of the noise power in a specific bandwidth relative to the video carrier level in the same bandwidth. CNR is specified over a 4MHz band—the video portion of the channel. See the *CNR Measurement* figure on page 3-10.

CNR adds on a power basis. If the amplifier input level and the noise figure are known, CNR can be calculated with the following formulas.

CNR for a Single Amplifier:

$$\mathbf{CNR} = \mathbf{Input\ Level(dBmV)} + \mathbf{59} - \mathbf{NF}$$

where **NF** = Noise Figure

► *To add similar CNR figures*

$$\mathbf{CNR}_S = \mathbf{CNR}_0 - 10\log N$$

where **N** = Number of **CNR** Figures

► *To add dissimilar CNR figures*

$$\mathbf{CNR}_S = (-10) \log \left[ 10^{\frac{-\mathbf{CNR}_1}{10}} + 10^{\frac{-\mathbf{CNR}_2}{10}} \dots + 10^{\frac{-\mathbf{CNR}_N}{10}} \right]$$

where:

**CNR<sub>0</sub>**, **CNR<sub>n</sub>** = **CNR** (dB) of a Single Amplifier (**n** = 1, 2, 3, ...**N**)

**CNR<sub>S</sub>** = System **CNR** (dB)

**59** = Thermal Noise in 4MHz Bandwidth (dBmV)

**N** = Number of Amplifiers in Cascade

**NF** = Noise Figure (dB)



**Note:** *Input level must be in dBmV.*

---

If the Noise Figure does not include the equalizer at the amplifier input, add 1 dB to the Noise Figure. This will decrease CNR by about 1 dB.

---



**Note:** *Every time you double a cascade of similar amplifiers, CNR degrades by 3dB.*

---

► **To graphically add CNR figures**

Use the *Combining CNR or CSO Ratios* figure on page 3-9 to estimate the combined effects of two amplifiers with known CNR values.

1. Calculate the CNR difference for the two amplifiers.
2. Locate the point corresponding to the difference between the two CNR values on the line graph.
3. Identify the “subtraction factor.”
4. Subtract the “subtraction factor” from the lowest CNR value to obtain the combined CNR value.

The *CNR Measurement* figure on page 3-10 illustrates noise and the visual carrier in a 6MHz channel. When measuring noise level, you must take into account several correction factors:

- Near noise floor (See “Spectrum Analyzer Error Correction Chart” on page 3-41)
- Frequency bandwidth to adjust for the resolution bandwidth
- A Log Conversion Shape supplied by the spectrum analyzer manufacturer

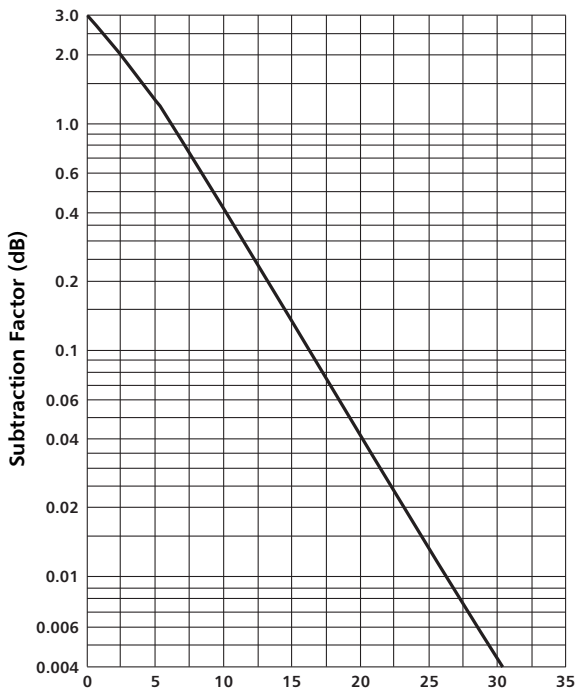

**Difference Between the Two Measurements (dB)**

**Combining CNR or CSO Ratios**

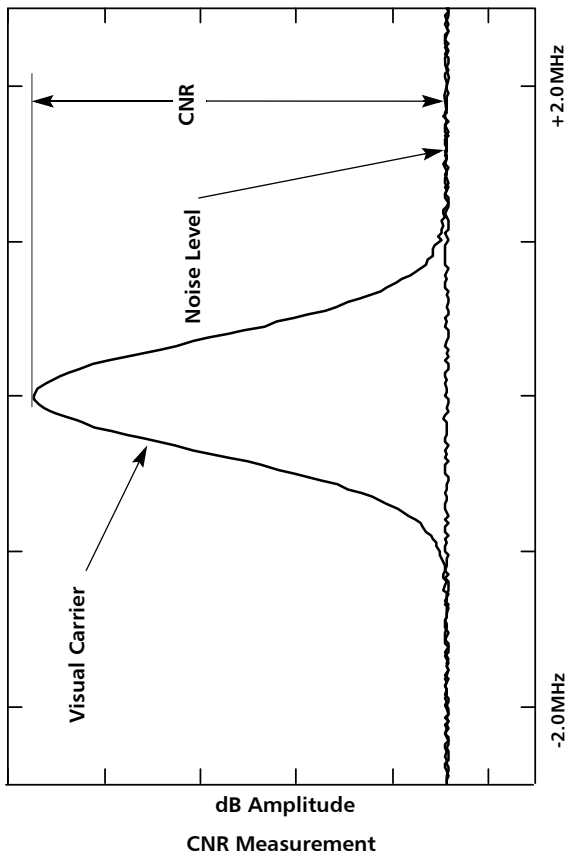

### 3.2.2 Composite Triple Beat (CTB)

CTB is the sum of the resultant beats produced by all combinations of  $\pm f_1 \pm f_2 \pm f_3$  that occur at a specified frequency. In multichannel systems using push-pull amplifiers, CTB is usually

the limiting performance factor. See the *CTB and CSO Beat Locations* figure on page 3-21 for the general locations of CTB beats.

CTB adds on a voltage basis. CTB ratios can be calculated as follows:

➤ *To add similar CTB ratios*

$$CTB_S = CTB_0 - 20 \log N$$

➤ *To add dissimilar CTB ratios*

$$CTB_S = (-20) \log \left[ 10^{\frac{-CTB_1}{20}} + 10^{\frac{-CTB_2}{20}} \dots + 10^{\frac{-CTB_N}{20}} \right]$$

where:

$CTB_0, CTB_n =$  **CTB** (dB) of a Single Amplifier ( $n = 1, 2, 3, \dots N$ )

$CTB_S =$  System **CTB** (dB)

**N** = Number of amplifiers in cascade



**Note:** Doubling the number of amplifiers with identical CTB ratios degrades the total CTB by 6dB. Reducing the amplifier output by 1 dB improves the CTB by about 2dB.

➤ *To graphically add CTB or Cross Modulation (XM) values*

Use the *Combining CTB or XM Values* figure on page 3-12 graph to estimate the combined effects of two amplifiers with known CNR values

1. Calculate the CNR difference for the two amplifiers.
2. Locate the point corresponding to the difference between the two CNR values on the line graph.
3. Identify the "subtraction factor."
4. Subtract the "subtraction factor" from the lowest CNR value to obtain the combined CNR value.

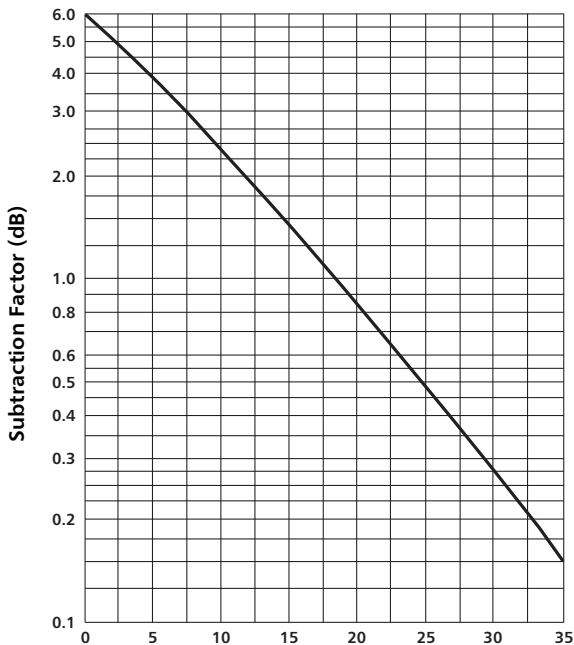

**Difference Between the Two Levels**

**Combining CTB or XM Values**

### 3.2.3 Cross Modulation (XM)

XM distortion is the result of modulation from one carrier imposed onto another carrier. XM calculations are identical to those of CTB.

XM adds on a voltage basis. CTB ratios can be calculated as follows:

- *To add similar XM ratios*

$$\mathbf{XM_S = XM_0 - 20\log N}$$

- *To add dissimilar XM ratios*

$$\mathbf{XM_S = (-20) \log \left[ 10^{\frac{-XM_1}{20}} + 10^{\frac{-XM_2}{20}} \dots + 10^{\frac{-XM_N}{20}} \right]}$$

where:

**XM<sub>S</sub>** = System **XM** (dB)

**XM<sub>0</sub>, XM<sub>n</sub>** = **XM** (dB) of a Single Amplifier (**n** = 1, 2, 3, ...**N**)

**N** = Number of Amplifiers in Cascade

Doubling the number of amplifiers with identical XM ratios degrades the total XM by 6 dB. Reducing the amplifier output by about 1 dB improves the XM by about 2 dB.

### 3.2.4 Carrier/Composite Triple Beat Ratio (CTB)

CTB at the output of a single amplifier operating at a given output level:

$$CTB = CTB_{ref} - 2(\text{Output Level} - \text{Reference Level})$$

To sum identical composite triple beat ratios:

$$CTB_s = CTB - 20 \log_{10} N$$

To sum differing composite triple beat ratios:

$$CTB_s = -20 \log_{10} \left( 10^{\frac{-CTB_1}{20}} + 10^{\frac{-CTB_2}{20}} + \dots + 10^{\frac{-CTB_n}{20}} \right)$$

Composite triple beat vs. channel loading:

$$\Delta CTB = 10 \log_{10} \left( \frac{\text{Number of Beats}_{ref}}{\text{Number of Beats}_{new}} \right)$$

See the Beat Table on page 3-16 to obtain the number of beats.

Rule: Single amplifier CTB improves by 2 dB with every 1 dB decrease in the output signal level.

Rule: Total CTB worsens by 6 dB with every double in the number of amplifiers with identical CTB.

CTB: Composite triple beat expressed as a positive number



### 3.2.5 Carrier/Single Second Order Ratio (SSO)

SSO at the output of a single amplifier operating at a given output level:

$$SSO = SSO_{ref} - (\text{Output Level} - \text{Reference Level})$$

To sum identical single second-order ratios:

$$SSO_s = SSO - 15 \log_{10} N$$

To sum differing single second-order ratios:

$$SSO_s = -15 \log_{10} (10^{\frac{-SSO_1}{15}} + 10^{\frac{-SSO_2}{15}} + \dots + 10^{\frac{-SSO_n}{15}})$$

**Rule:** Single-amplifier SSO improves by 1 dB with every 1 dB decrease in the output signal level.

SSO: Single second order expressed as a positive number

### 3.2.6 Carrier/Composite Intermodulation Noise Ratio (CIN)

It is assumed that CIN is dominated by third-order distortion (CIN3). This is the case in systems with analog television channels to 550 MHz and digital video above 550 MHz.

CIN at the output of a single amplifier operating at a given output level:

$$CIN = CIN_{ref} - 2(\text{Output Level} - \text{Reference Level})$$

To sum identical composite intermodulation noise ratios:

$$CIN_s = CIN - 20 \log_{10} N$$

To sum differing composite intermodulation noise ratios:

$$CIN_s = -20 \log_{10} \left( 10^{\frac{-CIN_1}{20}} + 10^{\frac{-CIN_2}{20}} + \dots + 10^{\frac{-CIN_n}{20}} \right)$$

To sum C/N and CIN:

$$C/N_s = -10 \log_{10} \left( 10^{\frac{-C/N}{10}} + 10^{\frac{-CIN}{10}} \right)$$

**Rule:** CIN behaves like CTB in a cascade of amplifiers, but it adds to the C/N.

**Rule:** Total CIN worsens by 6 dB with every double in the number of amplifiers with identical CIN.

CIN: Composite intermodulation noise expressed as a positive number

### 3.2.7 Carrier/Hum Modulation Ratio (C/H)

These calculations assume that all system power supplies are connected to the same power line phase.

To sum identical carrier/hum ratios:

$$C/H_s = C/H - 20 \log_{10} N$$

To sum differing carrier/hum ratios:

$$C/H_s = -20 \log_{10} \left( 10^{\frac{-C/H_1}{20}} + 10^{\frac{-C/H_2}{20}} + \dots + 10^{\frac{-C/H_n}{20}} \right)$$

To convert percent hum to C/H:

$$\%Hum = 100 \left( 10^{\frac{-C/H}{20}} \right)$$

To convert C/H to percent hum:

$$C/H = -20 \log_{10} \left( \frac{\%Hum}{100} \right)$$

C/H: Carrier-to-hum expressed as a positive number

### 3.2.8 Composite Second Order (CSO)

CSO is the distortion caused by the beats which result from all the possible combinations of two frequencies,  $\pm f_1 \pm f_1$ . See the *CTB and CSO Beat Locations* figure on page 3-21 for the general locations of CSO beats.

CSO adds on a power basis. CSO can be calculated as follows.

- *To add similar CSO ratios*

$$\mathbf{CSO_S = CSO_0 - 10\log N}$$

- *To add dissimilar CSO figures*

$$\mathbf{CSO_S = (-10) \log \left[ 10^{\frac{-CSO_1}{10}} + 10^{\frac{-CSO_2}{10}} \dots + 10^{\frac{-CSO_N}{10}} \right]}$$

where:

**CSO<sub>S</sub>** = System **CSO** (dB)

**CSO<sub>n</sub>**, **CSO<sub>n</sub>** = **CSO** (dB) of a Single Amplifier (**n** = 1, 2, 3, ...**N**)

**N** = Number of Amplifiers in Cascade



***Note:** Reducing amplifier output by 1 dB improves CSO by about 1 dB.*

***Note:** Every time you double a cascade of similar amplifiers, CSO degrades by 3 dB.*

---

### 3.2.9 Amplifier Cascade Factor

Cascade (N)	10 log(N)	15 log(N)	20 log(N)
1	0.00	0.00	0.00
2	3.01	4.52	6.02
3	4.77	7.16	9.54
4	6.02	9.03	12.04
5	6.99	10.48	13.98
6	7.78	11.67	15.56
7	8.45	12.68	16.90
8	9.03	13.55	18.06
9	9.54	14.31	19.08
10	10.00	15.00	20.00
11	10.41	15.62	20.83
12	10.79	16.19	21.58
13	11.14	16.71	22.28
14	11.46	17.19	22.92
15	11.76	17.64	23.52
16	12.04	18.06	24.08
17	12.30	18.46	24.61
18	12.55	18.83	25.11
19	12.79	19.18	25.58
20	13.01	19.52	26.02
21	13.22	19.83	26.44
22	13.42	20.14	26.85
23	13.62	20.43	27.23
24	13.80	20.70	27.60
25	13.98	20.97	27.96

### 3.3 Output Level on Performance

As output levels increase, CNR (Carrier-to-Noise Ratio) improves while CSO (Composite Second Order), CTB (Composite Triple Beat), and XM (Cross Modulation) degrade. As output levels decrease, CNR degrades, while CSO, CTB, and XM improve.

As a general rule, for every 1 dB *increase* in output level, CNR *increases* by 1 dB, CSO *decreases* by 1 dB, while CTB and XM *decrease* by 2 dB.

The **CNR** relationship to output for an amplifier is given by:

$$\mathbf{CNR}_1 = \mathbf{CNR}_0 + (\mathbf{L}_1 - \mathbf{L}_0)$$

where:

**CNR**<sub>0</sub> = Amplifier **CNR** at Level **L**<sub>0</sub> (dB)

**CNR**<sub>1</sub> = Amplifier **CNR** at (new) Level **L**<sub>1</sub> (dB)

The **CSO** relationship to output for an amplifier is given by:

$$\mathbf{CSO}_1 = \mathbf{CSO}_0 - (\mathbf{L}_1 - \mathbf{L}_0)$$

where:

**CSO**<sub>0</sub> = Amplifier **CSO** at Level **L**<sub>0</sub> (dB)

**CSO**<sub>1</sub> = Amplifier **CSO** at new Level **L**<sub>1</sub> (dB)

The **CTB** (or **XM**) relationship to output for an amplifier is given by:

$$\mathbf{CTB}_1 = \mathbf{CTB}_0 - 2(\mathbf{L}_1 - \mathbf{L}_0)$$

where:

**CTB**<sub>0</sub> = Amplifier **CTB** at Level **L**<sub>0</sub> (dB)

**CTB**<sub>1</sub> = Amplifier **CTB** at new Level **L**<sub>1</sub> (dB)

### 3.4 CSO and CTB

Composite Second Order (CSO) beats fall 1.25MHz above and below the visual carrier. Composite Triple Beats (CTB) fall directly under the carrier as shown below. Not shown are CSO beats that may also occur at 0.75MHz above and below the carrier at lower amplitudes.

FCC specifications require that the beats be a *minimum* of 51 dB below the carrier level. See reference to measurement correction factors on page 3-10.

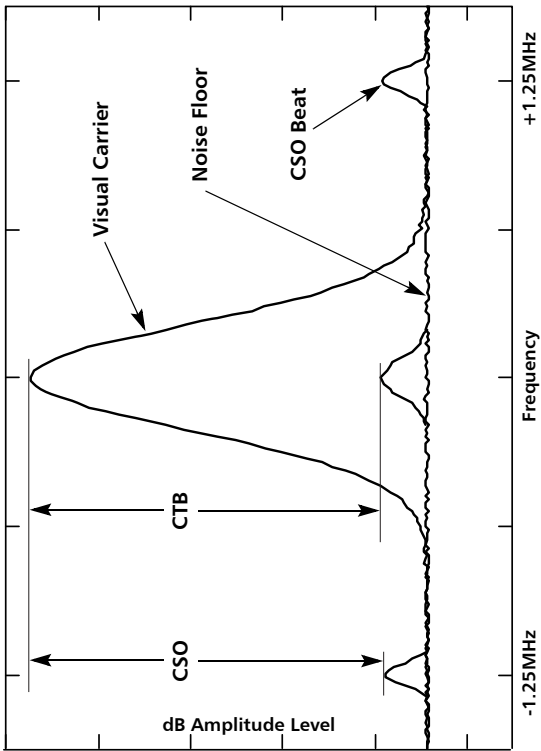

CTB and CSO Beat Locations

The following table gives the number of beats that accumulate at specific frequencies due to CTB and CSO for 60, 77, 96, 112, and 131 channel systems.

### System CTB and CSO for 60, 77, and 96 NTSC Channels

Visual Carrier Freq.	450MHz 60 Channels		550MHz 77 Channels			650MHz 96 Channels		
	CTB	CSO	CTB	CSO -1.25	CSO +1.25	CTB	CSO -1.25	CSO +1.25
55.25	615	2	1235	68	0	1903	85	0
61.25	640	2	1271	67	0	1946	84	0
67.25	661	2	1301	66	0	1986	83	0
77.25 <sup>1</sup>	56	45	1437	64	0	2156	81	0
83.25 <sup>1</sup>	56	44	1470	63	0	2196	80	0
121.25	868	2	1602	57	3	2362	74	3
127.25	894	2	1632	56	2	2402	73	2
133.25	918	2	1662	55	1	2439	72	1
139.25	939	2	1690	54	0	2477	71	0
145.25	960	2	1718	53	0	2512	70	0
151.25	979	2	1744	52	0	2548	69	0
157.25	998	2	1771	51	0	2582	68	0
163.25	1015	2	1796	50	2	2617	67	2
169.25	1032	2	1822	49	4	2650	66	4
175.25	1048	2	1845	48	6	2683	65	6
181.25	1064	2	1869	47	6	2714	64	6
187.25	1079	3	1890	46	6	2745	63	6
193.25	1093	3	1912	45	6	2774	62	6
199.25	1106	3	1931	44	6	2803	61	6
205.25	1118	3	1951	43	6	2830	60	6
211.25	1129	3	1968	42	6	2857	59	6
217.25	1139	3	1986	41	7	2882	58	7
223.25	1148	3	2001	40	8	2907	57	8
229.25	1156	3	2017	39	9	2930	56	9
235.25	1163	3	2030	38	10	2953	55	10
241.25	1169	4	2044	37	11	2974	54	11
247.25	1174	4	2055	36	12	2995	53	12
253.25	1178	5	2067	35	13	3014	52	13
259.25	1181	5	2076	34	14	3033	51	14
265.25	1183	6	2086	33	15	3050	50	15
271.25	1184	6	2093	32	16	3067	49	16
277.25	1184	7	2101	31	17	3082	48	17
283.25	1183	7	2106	30	18	3097	47	18



## System CTB and CSO for 60, 77, and 96 NTSC Channels

Visual Carrier Freq.	450MHz 60 Channels		550MHz 77 Channels			650MHz 96 Channels		
	CTB	CSO	CTB	CSO -1.25	CSO +1.25	CTB	CSO -1.25	CSO +1.25
289.25	1181	8	2112	29	19	3110	46	19
295.25	1178	8	2115	28	20	3123	45	20
301.25	1174	9	2119	27	21	3134	44	21
307.25	1169	9	2120	26	22	3145	43	22
313.25	1163	10	2122	25	23	3154	42	23
319.25	1156	10	2121	24	24	3163	41	24
325.25	1148	11	2121	23	25	3170	40	25
331.25	1139	11	2118	22	26	3177	39	26
337.25	1129	12	2116	21	27	3182	38	27
343.25	1118	12	2111	20	28	3187	37	28
349.25	1106	13	2107	19	29	3190	36	29
355.25	1093	13	2100	18	30	3193	35	30
361.25	1079	14	2094	17	31	3194	34	31
367.25	1064	14	2085	16	32	3195	33	32
373.25	1048	15	2077	15	33	3194	32	33
379.25	1031	15	2066	14	34	3193	31	34
385.25	1013	16	2056	13	35	3190	30	35
391.25	995	16	2043	12	36	3187	29	36
397.25	977	17	2031	11	37	3182	28	37
403.25	959	17	2016	10	38	3177	27	38
409.25	940	18	2002	9	39	3170	26	39
415.25	920	18	1985	8	40	3163	25	40
421.25	899	19	1969	7	41	3154	24	41
427.25	877	19	1950	6	42	3145	23	42
433.25	854	20	1932	5	43	3134	22	43
439.25	829	20	1911	4	44	3123	21	44
445.25	801	21	1891	3	45	3110	20	45
451.25	-	-	1868	3	46	3097	19	46
457.25	-	-	1846	3	47	3082	18	47
463.25	-	-	1821	3	48	3067	17	48
469.25	-	-	1797	3	49	3050	16	49
475.25	-	-	1770	3	50	3033	15	50
481.25	-	-	1744	3	51	3014	14	51
487.25	-	-	1715	2	52	2995	13	52
493.25	-	-	1687	1	53	2974	12	53
499.25	-	-	1656	0	54	2953	11	54
505.25	-	-	1627	0	55	2930	10	55

## System CTB and CSO for 60, 77, and 96 NTSC Channels

Visual Carrier Freq.	450MHz 60 Channels		550MHz 77 Channels			650MHz 96 Channels		
	CTB	CSO	CTB	CSO -1.25	CSO +1.25	CTB	CSO -1.25	CSO +1.25
511.25	-	-	1596	0	56	2907	9	56
517.25	-	-	1567	0	57	2882	8	57
523.25	-	-	1535	0	58	2857	7	58
529.25	-	-	1504	0	59	2830	6	59
535.25	-	-	1470	0	60	2803	5	60
541.25	-	-	1436	0	61	2774	4	61
547.25	-	-	1398	0	62	2745	3	62
553.25	-	-	-	-	-	2714	3	63
559.25	-	-	-	-	-	2683	3	64
565.25	-	-	-	-	-	2650	3	65
571.25	-	-	-	-	-	2617	3	66
577.25	-	-	-	-	-	2582	3	67
583.25	-	-	-	-	-	2547	3	68
589.25	-	-	-	-	-	2510	2	69
595.25	-	-	-	-	-	2473	1	70
601.25	-	-	-	-	-	2434	0	71
607.25	-	-	-	-	-	2396	0	72
613.25	-	-	-	-	-	2357	0	73
619.25	-	-	-	-	-	2319	0	74
625.25	-	-	-	-	-	2279	0	75
631.25	-	-	-	-	-	2239	0	76
637.25	-	-	-	-	-	2197	0	77
643.25	-	-	-	-	-	2154	0	78
649.25	-	-	-	-	-	2108	0	79

1. Because NTSC channels 5 and 6 do not fall at the regular 6MHz spacing, beats are offset from the normal beat locations by +2.0MHz (i.e., CTB is located at +2.0MHz, and CSO products are located at +0.75 and +2.75MHz from the carrier).

## System CTB and CSO for 112 and 131 NTSC Channels

Visual Carrier Freq.	750MHz 112 Channels			860MHz 131 Channels		
	CTB	CSO -1.25	CSO +1.25	CTB	CSO -1.25	CSO +1.25
55.25	2663	101	0	3731	120	0
61.25	2714	100	0	3793	119	0
67.25	2762	99	0	3849	118	0
77.25 <sup>1</sup>	2964	97	0	4089	116	0
83.25 <sup>1</sup>	3012	96	0	4148	115	0
121.25	3210	90	3	4384	109	3
127.25	3258	89	2	4440	108	2
133.25	3303	88	1	4496	107	1
139.25	3349	87	0	4550	106	0
145.25	3392	86	0	4604	105	0
151.25	3436	85	0	4656	104	0
157.25	3478	84	0	4709	103	0
163.25	3521	83	2	4760	102	2
169.25	3562	82	4	4812	101	4
175.25	3603	81	6	4861	100	6
181.25	3642	80	6	4911	99	6
187.25	3681	79	6	4958	98	6
193.25	3718	78	6	5006	97	6
199.25	3755	77	6	5051	96	6
205.25	3790	76	6	5097	95	6
211.25	3825	75	6	5140	94	6
217.25	3858	74	7	5184	93	7
223.25	3891	73	8	5225	92	8
229.25	3922	72	9	5267	91	9
235.25	3953	71	10	5306	90	10
241.25	3982	70	11	5346	89	11
247.25	4011	69	12	5383	88	12
253.25	4038	68	13	5421	87	13
259.25	4065	67	14	5456	86	14
265.25	4090	66	15	5492	85	15
271.25	4115	65	16	5525	84	16
277.25	4138	64	17	5559	83	17
283.25	4161	63	18	5590	82	18
289.25	4182	62	19	5622	81	19
295.25	4203	61	20	5651	80	20
301.25	4222	60	21	5681	79	21

## System CTB and CSO for 112 and 131 NTSC Channels

Visual Carrier Freq.	750MHz 112 Channels			860MHz 131 Channels		
	CTB	CSO -1.25	CSO +1.25	CTB	CSO -1.25	CSO +1.25
307.25	4241	59	22	5708	78	22
313.25	4258	58	23	5736	77	23
319.25	4275	57	24	5761	76	24
325.25	4290	56	25	5787	75	25
331.25	4305	55	26	5810	74	26
337.25	4318	54	27	5834	73	27
343.25	4331	53	28	5855	72	28
349.25	4342	52	29	5877	71	29
355.25	4353	51	30	5896	70	30
361.25	4362	50	31	5916	69	31
367.25	4371	49	32	5933	68	32
373.25	4378	48	33	5951	67	33
379.25	4385	47	34	5966	66	34
385.25	4390	46	35	5982	65	35
391.25	4395	45	36	5995	64	36
397.25	4398	44	37	6009	63	37
403.25	4401	43	38	6020	62	38
409.25	4402	42	39	6032	61	39
415.25	4403	41	40	6041	60	40
421.25	4402	40	41	6051	59	41
427.25	4401	39	42	6058	58	42
433.25	4398	38	43	6066	57	43
439.25	4395	37	44	6071	56	44
445.25	4390	36	45	6077	55	45
451.25	4385	35	46	6080	54	46
457.25	4378	34	47	6084	53	47
463.25	4371	33	48	6085	52	48
469.25	4362	32	49	6087	51	49
475.25	4353	31	50	6086	50	50
481.25	4342	30	51	6086	49	51
487.25	4331	29	52	6083	48	52
493.25	4318	28	53	6081	47	53
499.25	4305	27	54	6076	46	54
505.25	4290	26	55	6072	45	55
511.25	4275	25	56	6065	44	56
517.25	4258	24	57	6059	43	57
523.25	4241	23	58	6050	42	58

## System CTB and CSO for 112 and 131 NTSC Channels

Visual Carrier Freq.	750MHz 112 Channels			860MHz 131 Channels		
	CTB	CSO -1.25	CSO +1.25	CTB	CSO -1.25	CSO +1.25
529.25	4222	22	59	6042	41	59
535.25	4203	21	60	6031	40	60
541.25	4182	20	61	6021	39	61
547.25	4161	19	62	6008	38	62
553.25	4138	18	63	5996	37	63
559.25	4115	17	64	5981	36	64
565.25	4090	16	65	5967	35	65
571.25	4065	15	66	5950	34	66
577.25	4038	14	67	5934	33	67
583.25	4011	13	68	5915	32	68
589.25	3982	12	69	5897	31	69
595.25	3953	11	70	5876	30	70
601.25	3922	10	71	5856	29	71
607.25	3891	9	72	5833	28	72
613.25	3858	8	73	5811	27	73
619.25	3825	7	74	5786	26	74
625.25	3790	6	75	5762	25	75
631.25	3755	5	76	5735	24	76
637.25	3718	4	77	5709	23	77
643.25	3681	3	78	5680	22	78
649.25	3642	3	79	5652	21	79
655.25	3603	3	80	5621	20	80
661.25	3562	3	81	5591	19	81
667.25	3521	3	82	5558	18	82
673.25	3478	3	83	5526	17	83
679.25	3435	3	84	5491	16	84
685.25	3390	2	85	5457	15	85
691.25	3345	1	86	5420	14	86
697.25	3298	0	87	5384	13	87
703.25	3252	0	88	5345	12	88
709.25	3205	0	89	5307	11	89
715.25	3159	0	90	5266	10	90
721.25	3111	0	91	5226	9	91
727.25	3063	0	92	5183	8	92
733.25	3013	0	93	5141	7	93
739.25	2962	0	94	5096	6	94
745.25	2908	0	95	5052	5	95

## System CTB and CSO for 112 and 131 NTSC Channels

Visual Carrier Freq.	750MHz 112 Channels			860MHz 131 Channels		
	CTB	CSO -1.25	CSO +1.25	CTB	CSO -1.25	CSO +1.25
751.25	-	-	-	5005	4	96
757.25	-	-	-	4959	3	97
763.25	-	-	-	4910	3	98
769.25	-	-	-	4862	3	99
775.25	-	-	-	4811	3	100
781.25	-	-	-	4761	3	101
787.25	-	-	-	4708	3	102
793.25	-	-	-	4656	3	103
799.25	-	-	-	4601	2	104
805.25	-	-	-	4547	1	105
811.25	-	-	-	4490	0	106
817.25	-	-	-	4435	0	107
823.25	-	-	-	4378	0	108
829.25	-	-	-	4323	0	109
835.25	-	-	-	4265	0	110
841.25	-	-	-	4208	0	111
847.25	-	-	-	4148	0	112
853.25	-	-	-	4088	0	113
859.25	-	-	-	4024	0	114

1. Because NTSC channels 5 and 6 do not fall at the regular 6MHz spacing, beats are offset from the normal beat locations by +2.0MHz (i.e., CTB is located at +2.0MHz, and CSO products are located at +0.75 and +2.75MHz from the carrier).

## System CTB and CSO for 29, 35, & 42 CENELEC Channels

Visual Carrier Freq.	600MHz 29 Channels			750MHz 35 Channels			860MHz 42 Channels		
	CTB	CSO -0.75	CSO +0.75	CTB	CSO -0.75	CSO +0.75	CTB	CSO -0.75	CSO +0.75
48.25 <sup>1</sup>	0	0	0	0	0	0	0	0	0
119.25	71	0	14	100	0	15	147	0	15
175.25	106	0	7	159	0	8	199	0	12
191.25	117	0	7	170	0	7	210	0	11
207.25	122	0	6	171	0	6	211	0	9
223.25	114	0	6	156	0	7	197	0	10

## System CTB and CSO for 29, 35, & 42 CENELEC Channels

Visual Carrier Freq.	600MHz 29 Channels			750MHz 35 Channels			860MHz 42 Channels		
	CTB	CSO -0.75	CSO +0.75	CTB	CSO -0.75	CSO +0.75	CTB	CSO -0.75	CSO +0.75
231.25	88	0	7	130	0	12	209	0	14
247.25	102	0	5	151	0	9	231	0	12
263.25	107	0	4	160	0	7	238	0	11
287.25	108	0	6	133	0	11	184	0	12
311.25	131	2	2	186	2	2	270	2	9
327.25	139	2	1	199	2	1	284	2	7
343.25	143	2	2	204	2	2	289	2	7
359.25	141	0	3	206	0	3	289	0	7
375.25	140	0	4	206	0	5	287	0	8
391.25	139	0	4	207	0	5	288	0	7
407.25	135	4	3	203	4	4	285	4	5
423.25	124	4	2	190	4	3	275	4	3
439.25	107	6	0	167	6	2	255	6	2
447.25	127	3	1	180	3	4	244	3	11
463.25	138	5	1	199	5	4	262	5	10
479.25	140	6	1	207	6	4	269	6	9
495.25	135	7	0	208	7	2	269	7	7
511.25	130	6	0	209	6	1	272	6	6
527.25	121	3	0	204	3	0	272	3	5
543.25	106	4	0	189	4	1	265	4	5
567.25	91	10	0	142	10	1	233	10	5
583.25	97	10	0	151	10	0	243	10	4
599.25	92	12	0	151	12	0	241	12	4
663.25	-	-	-	159	6	0	257	6	2
679.25	-	-	-	163	4	0	268	4	1
695.25	-	-	-	157	6	0	266	6	0
711.25	-	-	-	148	8	0	264	8	0
727.25	-	-	-	133	8	0	258	8	0
743.25	-	-	-	116	8	0	257	8	0
759.25	-	-	-	-	-	-	248	12	0
775.25	-	-	-	-	-	-	239	16	0
791.25	-	-	-	-	-	-	226	16	0
807.25	-	-	-	-	-	-	217	14	0
823.25	-	-	-	-	-	-	208	12	0
839.25	-	-	-	-	-	-	198	14	0
855.25	-	-	-	-	-	-	179	20	0

1. Because CENELEC channel at 48.25MHz does not fall at the regular 8MHz spacing, beats are offset from the normal beat locations by  $-2.0\text{MHz}$  (i.e., CTB is located at  $-2.0\text{MHz}$ , and CSO products are located at  $-1.75$  and  $-0.25\text{MHz}$  from the carrier).

### System CTB and CSO for 63 and 76 PAL B/G Channels

Visual Carrier Freq. (MHz)	550MHz 63 Channels			650MHz 76 Channels		
	CTB	CSO $-0.75$	CSO $+0.75$	CTB	CSO $-0.75$	CSO $+0.75$
48.25	183	26 <sup>1</sup>	21	235	39 <sup>1</sup>	21
55.25	188	11	44	288	1 <sup>1</sup>	57
62.25	185	1 <sup>1</sup>	29 <sup>2</sup>	237	1 <sup>1</sup>	42 <sup>2</sup>
69.25	181	1 <sup>1</sup>	24 <sup>3</sup>	220	1 <sup>1</sup>	37 <sup>3</sup>
76.25	172	1 <sup>1</sup>	23 <sup>4</sup>	211	1 <sup>1</sup>	36 <sup>4</sup>
112.25	273	30 <sup>1</sup>	7	325	43 <sup>1</sup>	7
119.25	310	12 <sup>1</sup>	23	462	12 <sup>1</sup>	36
126.25	302	11 <sup>1</sup>	18 <sup>2</sup>	354	11 <sup>1</sup>	31 <sup>2</sup>
133.25	305	10 <sup>1</sup>	17 <sup>3</sup>	344	10 <sup>1</sup>	30 <sup>3</sup>
140.25	312	9 <sup>1</sup>	16 <sup>4</sup>	351	9 <sup>1</sup>	29 <sup>4</sup>
147.25	297	8 <sup>1</sup>	7	323	8 <sup>1</sup>	7
154.25	302	7 <sup>1</sup>	7	328	7 <sup>1</sup>	7
161.25	310	14 <sup>5</sup>	7	336	27 <sup>5</sup>	7
168.25	355	16 <sup>1</sup>	8	407	29 <sup>1</sup>	8
175.25	424	6	17	623	6	30
182.25	364	8	12 <sup>2</sup>	416	8	25 <sup>2</sup>
189.25	351	10	11 <sup>3</sup>	390	10	24 <sup>3</sup>
196.25	351	10	10 <sup>4</sup>	390	10	23 <sup>4</sup>
203.25	336	10	8	362	10	8
210.25	335	10	8	361	10	8
217.25	336	10	8	362	21 <sup>5</sup>	8
224.25	361	10	8	413	20 <sup>1</sup>	8
231.25	492	10	9	735	10	22
238.25	357	10	6	409	10	18 <sup>2</sup>
245.25	330	10	5 <sup>3</sup>	369	10	18 <sup>3</sup>
252.25	324	10	5 <sup>6</sup>	363	10	17 <sup>4</sup>
259.25	309	10	6	335	10	6 <sup>6</sup>
266.25	302	10	7 <sup>6</sup>	328	10	7 <sup>6</sup>
273.25	295	10	8 <sup>6</sup>	321	15	8 <sup>6</sup>
280.25	298	10	9 <sup>6</sup>	350	14 <sup>1</sup>	9 <sup>6</sup>
287.25	511	10	10 <sup>6</sup>	801	10	13
294.25	273	10	11	325	10	12 <sup>2</sup>



## System CTB and CSO for 63 and 76 PAL B/G Channels

Visual Carrier Freq. (MHz)	550MHz 63 Channels			650MHz 76 Channels		
	CTB	CSO -0.75	CSO +0.75	CTB	CSO -0.75	CSO +0.75
303.25	349	4 <sup>1</sup>	4	652	5 <sup>1</sup>	11
311.25	360	4 <sup>1</sup>	10 <sup>7</sup>	667	5 <sup>1</sup>	10
319.25	365	4 <sup>1</sup>	15 <sup>7</sup>	682	5 <sup>1</sup>	15 <sup>7</sup>
327.25	375	3 <sup>1</sup>	16 <sup>8</sup>	696	5 <sup>1</sup>	16 <sup>8</sup>
335.25	381	3 <sup>1</sup>	17 <sup>9</sup>	709	5 <sup>1</sup>	17 <sup>9</sup>
343.25	489	10	18 <sup>6</sup>	821	10	18 <sup>6</sup>
351.25	456	19	3	795	19	5
359.25	418	3 <sup>1</sup>	3	761	5 <sup>1</sup>	5
367.25	425	3 <sup>1</sup>	3	775	5 <sup>1</sup>	4
375.25	425	3 <sup>1</sup>	23 <sup>7</sup>	783	4 <sup>1</sup>	23 <sup>7</sup>
383.25	424	2	24 <sup>8</sup>	791	4 <sup>1</sup>	24 <sup>8</sup>
391.25	427	2	25 <sup>9</sup>	797	4 <sup>1</sup>	25 <sup>9</sup>
399.25	463	2	28 <sup>6</sup>	839	4 <sup>1</sup>	28 <sup>6</sup>
407.25	472	29	2	851	29	4
415.25	437	2	4 <sup>6</sup>	823	4 <sup>1</sup>	4
423.25	441	4	4 <sup>6</sup>	828	4	4 <sup>6</sup>
431.25	433	4	23 <sup>7</sup>	831	4	23 <sup>7</sup>
439.25	421	4	22 <sup>8</sup>	833	4	22 <sup>8</sup>
447.25	416	4	21 <sup>9</sup>	834	4	21 <sup>9</sup>
455.25	417	4	24 <sup>6</sup>	838	4	24 <sup>6</sup>
463.25	430	23	4 <sup>6</sup>	857	23	4 <sup>6</sup>
471.25	404	4	6 <sup>6</sup>	834	4	6 <sup>6</sup>
479.25	400	6	6 <sup>6</sup>	832	6	6 <sup>6</sup>
487.25	389	6	17 <sup>7</sup>	826	6	17 <sup>7</sup>
495.25	361	6	16 <sup>8</sup>	823	6	16 <sup>8</sup>
503.25	353	6	15 <sup>9</sup>	818	6	15 <sup>9</sup>
511.25	342	6	18 <sup>6</sup>	813	6	18 <sup>6</sup>
519.25	336	17	6 <sup>6</sup>	810	17	6 <sup>6</sup>
527.25	319	6	8 <sup>6</sup>	799	6	8 <sup>6</sup>
535.25	310	8	8 <sup>6</sup>	789	8	8 <sup>6</sup>
543.25	297	8	11 <sup>7</sup>	770	8	11 <sup>7</sup>
551.25	-	-	-	760	8	10 <sup>8</sup>
559.25	-	-	-	751	8	9 <sup>9</sup>
567.25	-	-	-	739	8	12 <sup>6</sup>
575.25	-	-	-	728	11	8 <sup>6</sup>
583.25	-	-	-	714	8	10 <sup>6</sup>
591.25	-	-	-	697	10	10 <sup>6</sup>

## System CTB and CSO for 63 and 76 PAL B/G Channels

Visual Carrier Freq. (MHz)	550MHz 63 Channels			650MHz 76 Channels		
	CTB	CSO -0.75	CSO +0.75	CTB	CSO -0.75	CSO +0.75
599.25	-	-	-	663	10	10 <sup>6</sup>
607.25	-	-	-	649	11	10 <sup>6</sup>
615.25	-	-	-	632	12	10 <sup>6</sup>
623.25	-	-	-	616	13	10 <sup>6</sup>
631.25	-	-	-	597	14	10 <sup>6</sup>
639.25	-	-	-	579	15	10 <sup>6</sup>
647.25	-	-	-	560	16	10 <sup>6</sup>

1. Maximum beats are located at -0.25MHz from carrier.
2. Maximum beats are located at +1.75MHz from carrier.
3. Maximum beats are located at +2.75MHz from carrier.
4. Maximum beats are located at +3.75MHz from carrier.
5. Maximum beats are located at -1.25MHz from carrier.
6. Maximum beats are located at +0.25MHz from carrier.
7. Maximum beats are located at +3.25MHz from carrier.
8. Maximum beats are located at +2.25MHz from carrier.
9. Maximum beats are located at +1.25MHz from carrier.

## System CTB and CSO for 88 and 102 PAL B/G Channels

Visual Carrier Freq. (MHz)	550MHz 88 Channels			650MHz 102 Channels		
	CTB	CSO -0.75	CSO +0.75	CTB	CSO -0.75	CSO +0.75
48.25	399 <sup>1</sup>	51 <sup>2</sup>	21	693 <sup>1</sup>	65 <sup>2</sup>	21
55.25	456	1	69	743	1 <sup>2</sup>	83
62.25	533 <sup>3</sup>	1	54 <sup>4</sup>	841 <sup>3</sup>	1 <sup>2</sup>	68 <sup>4</sup>
69.25	442 <sup>5</sup>	1	49 <sup>6</sup>	757 <sup>5</sup>	1 <sup>2</sup>	63 <sup>6</sup>
76.25	460 <sup>7</sup>	1	48 <sup>8</sup>	782 <sup>7</sup>	1 <sup>2</sup>	62 <sup>8</sup>
112.25	620 <sup>1</sup>	55 <sup>2</sup>	7	970 <sup>1</sup>	69 <sup>2</sup>	7
119.25	678	12 <sup>2</sup>	48	1021	12 <sup>2</sup>	62
126.25	563 <sup>3</sup>	11 <sup>2</sup>	43 <sup>4</sup>	927 <sup>3</sup>	11 <sup>2</sup>	57 <sup>4</sup>
133.25	584 <sup>5</sup>	10 <sup>2</sup>	42 <sup>6</sup>	955 <sup>5</sup>	10 <sup>2</sup>	56 <sup>6</sup>
140.25	604 <sup>7</sup>	9 <sup>2</sup>	41 <sup>8</sup>	982 <sup>7</sup>	9 <sup>2</sup>	55 <sup>8</sup>
147.25	623 <sup>9</sup>	8 <sup>2</sup>	7	1008 <sup>9</sup>	8 <sup>2</sup>	7
154.25	352	7 <sup>2</sup>	7	380	7 <sup>2</sup>	7
161.25	360	39 <sup>10</sup>	7	388	53 <sup>10</sup>	7
168.25	714 <sup>1</sup>	41 <sup>2</sup>	8	1113 <sup>1</sup>	55 <sup>2</sup>	8
175.25	881	6	42	1273	6	56

## System CTB and CSO for 88 and 102 PAL B/G Channels

Visual Carrier Freq. (MHz)	550MHz 88 Channels			650MHz 102 Channels		
	CTB	CSO -0.75	CSO +0.75	CTB	CSO -0.75	CSO +0.75
182.25	709 <sup>3</sup>	8	37 <sup>4</sup>	1122 <sup>3</sup>	8	51 <sup>4</sup>
189.25	732 <sup>5</sup>	10	36 <sup>6</sup>	1152 <sup>5</sup>	10	50 <sup>6</sup>
196.25	752 <sup>7</sup>	10	35 <sup>8</sup>	1179 <sup>7</sup>	10	49 <sup>8</sup>
203.25	774 <sup>9</sup>	10	8	1208 <sup>9</sup>	10	8
210.25	385	10	8	413	10	8
217.25	386	33 <sup>10</sup>	8	414	47 <sup>10</sup>	8
224.25	832 <sup>1</sup>	32 <sup>2</sup>	8	1280 <sup>1</sup>	46 <sup>2</sup>	8
231.25	1035	10	34	1476	10	48
238.25	890 <sup>3</sup>	10	30 <sup>4</sup>	1352 <sup>3</sup>	10	44 <sup>4</sup>
245.25	901 <sup>5</sup>	10	30 <sup>6</sup>	1370 <sup>5</sup>	10	44 <sup>6</sup>
252.25	924 <sup>7</sup>	10	29 <sup>8</sup>	1400 <sup>7</sup>	10	43 <sup>8</sup>
259.25	946 <sup>9</sup>	10	6 <sup>11</sup>	1429 <sup>9</sup>	10	6 <sup>11</sup>
266.25	352	10	7 <sup>11</sup>	380	10	7 <sup>11</sup>
273.25	345	27 <sup>10</sup>	8 <sup>11</sup>	373	41 <sup>10</sup>	8 <sup>11</sup>
280.25	991 <sup>1</sup>	26 <sup>2</sup>	9 <sup>11</sup>	1488 <sup>1</sup>	40 <sup>2</sup>	9 <sup>11</sup>
287.25	1143	10	25	1633	10	39
294.25	1087 <sup>3</sup>	10	24 <sup>4</sup>	1598 <sup>3</sup>	10	38 <sup>4</sup>
303.25	1006	5 <sup>2</sup>	23	1510	5 <sup>2</sup>	37
311.25	1027	5 <sup>2</sup>	22	1538	5 <sup>2</sup>	36
319.25	1048	5 <sup>2</sup>	21	1566	5 <sup>2</sup>	35
327.25	1068	5 <sup>2</sup>	20	1593	5 <sup>2</sup>	34
335.25	1087	5 <sup>2</sup>	19	1619	5 <sup>2</sup>	33
343.25	1205	10	18	1744	10	32
351.25	1185	19	17	1731	19	31
359.25	1157	5 <sup>2</sup>	16	1710	5 <sup>2</sup>	30
367.25	1177	5 <sup>2</sup>	15	1737	5 <sup>2</sup>	29
375.25	1191	5 <sup>2</sup>	23 <sup>12</sup>	1758	5 <sup>2</sup>	28
383.25	1205	5 <sup>2</sup>	24 <sup>13</sup>	1779	5 <sup>2</sup>	27
391.25	1217	5 <sup>2</sup>	25 <sup>14</sup>	1798	5 <sup>2</sup>	26
399.25	1265	5 <sup>2</sup>	28 <sup>11</sup>	1853	5 <sup>2</sup>	28 <sup>11</sup>
407.25	1283	29	10	1878	29	24
415.25	1260	5 <sup>2</sup>	9	1862	5 <sup>2</sup>	23
423.25	1273	5 <sup>2</sup>	8	1882	5 <sup>2</sup>	22
431.25	1281	5 <sup>2</sup>	23 <sup>12</sup>	1897	5 <sup>2</sup>	23 <sup>12</sup>
439.25	1288	5 <sup>2</sup>	22 <sup>13</sup>	1911	5 <sup>2</sup>	22 <sup>13</sup>
447.25	1294	5 <sup>2</sup>	21 <sup>14</sup>	1924	5 <sup>2</sup>	21 <sup>14</sup>
455.25	1303	5 <sup>2</sup>	24 <sup>11</sup>	1940	5 <sup>2</sup>	24 <sup>11</sup>

## System CTB and CSO for 88 and 102 PAL B/G Channels

Visual Carrier Freq. (MHz)	550MHz 88 Channels			650MHz 102 Channels		
	CTB	CSO -0.75	CSO +0.75	CTB	CSO -0.75	CSO +0.75
463.25	1327	23	4	1971	23	17
471.25	1309	4	6 <sup>11</sup>	1960	5 <sup>2</sup>	16
479.25	1316	6	6 <sup>11</sup>	1974	6	15
487.25	1317	6	17 <sup>12</sup>	1982	6	17 <sup>12</sup>
495.25	1318	6	16 <sup>13</sup>	1990	6	13
503.25	1317	6	15 <sup>14</sup>	1996	6	15 <sup>14</sup>
511.25	1317	6	18 <sup>11</sup>	2002	6	18 <sup>11</sup>
519.25	1316	17	6 <sup>11</sup>	2010	17	10
527.25	1310	6	8 <sup>11</sup>	2010	6	9
535.25	1309	8	8 <sup>11</sup>	2015	8	8
543.25	1305	8	11 <sup>12</sup>	2017	8	11 <sup>12</sup>
551.25	1299	8	10 <sup>13</sup>	2017	8	10 <sup>13</sup>
559.25	1294	8	9 <sup>14</sup>	2018	8	9 <sup>14</sup>
567.25	1286	8	12 <sup>11</sup>	2016	8	12 <sup>11</sup>
575.25	1275	11	8 <sup>11</sup>	2015	11	8 <sup>11</sup>
583.25	1263	8	10 <sup>11</sup>	2011	8	10 <sup>11</sup>
591.25	1255	10	10 <sup>11</sup>	2008	10	10 <sup>11</sup>
599.25	1244	10	10 <sup>11</sup>	2002	10	10 <sup>11</sup>
607.25	1234	11	10 <sup>11</sup>	1997	11	10 <sup>11</sup>
615.25	1221	12	10 <sup>11</sup>	1989	12	10 <sup>11</sup>
623.25	1209	13	10 <sup>11</sup>	1983	13	10 <sup>11</sup>
631.25	1190	14	10 <sup>11</sup>	1971	14	10 <sup>11</sup>
639.25	1166	15	10 <sup>11</sup>	1963	15	10 <sup>11</sup>
647.25	1150	16	10 <sup>11</sup>	1952	16	10 <sup>11</sup>
655.25	1135	17	10 <sup>11</sup>	1942	17	10 <sup>11</sup>
663.25	1117	18	10 <sup>11</sup>	1929	18	10 <sup>11</sup>
671.25	1100	19	10 <sup>11</sup>	1917	19	10 <sup>11</sup>
679.25	1080	20	10 <sup>11</sup>	1902	20	10 <sup>11</sup>
687.25	1057	21	10 <sup>11</sup>	1884	21	10 <sup>11</sup>
695.25	1017	22	10 <sup>11</sup>	1865	22	10 <sup>11</sup>
703.25	997	23	10 <sup>11</sup>	1850	23	10 <sup>11</sup>
711.25	974	24	10 <sup>11</sup>	1832	24	10 <sup>11</sup>
719.25	952	25	10 <sup>11</sup>	1815	25	10 <sup>11</sup>
727.25	927	26	10 <sup>11</sup>	1795	26	10 <sup>11</sup>
735.25	903	27	10 <sup>11</sup>	1776	27	10 <sup>11</sup>
743.25	878	28	10 <sup>11</sup>	1750	28	10 <sup>11</sup>
751.25	-	-	-	1719	29	10 <sup>11</sup>

## System CTB and CSO for 88 and 102 PAL B/G Channels

Visual Carrier Freq. (MHz)	550MHz 88 Channels			650MHz 102 Channels		
	CTB	CSO -0.75	CSO +0.75	CTB	CSO -0.75	CSO +0.75
759.25	-	-	-	1696	30	10 <sup>11</sup>
767.25	-	-	-	1674	31	10 <sup>11</sup>
775.25	-	-	-	1649	32	10 <sup>11</sup>
783.25	-	-	-	1625	33	10 <sup>11</sup>
791.25	-	-	-	1598	34	10 <sup>11</sup>
799.25	-	-	-	1568	35	10 <sup>11</sup>
807.25	-	-	-	1521	36	10 <sup>11</sup>
815.25	-	-	-	1494	37	10 <sup>11</sup>
823.25	-	-	-	1464	38	10 <sup>11</sup>
831.25	-	-	-	1435	39	10 <sup>11</sup>
839.25	-	-	-	1403	40	10 <sup>11</sup>
847.25	-	-	-	1372	41	10 <sup>11</sup>
855.25	-	-	-	1340	42	10 <sup>11</sup>

1. Maximum CTB occurs at -1.0MHz.
2. Maximum beats are located at -0.25MHz from carrier.
3. Maximum CTB occurs at +1.0MHz.
4. Maximum beats are located at +1.75MHz from carrier.
5. Maximum CTB occurs at +2.0MHz.
6. Maximum beats are located at +2.75MHz from carrier.
7. Maximum CTB occurs at +3.0MHz.
8. Maximum beats are located at +3.75MHz from carrier.
9. Maximum CTB occurs at +4.0MHz.
10. Maximum beats are located at -1.25MHz from carrier.
11. Maximum beats are located at +0.25MHz from carrier.
12. Maximum beats are located at +3.25MHz from carrier.
13. Maximum beats are located at +2.25MHz from carrier.
14. Maximum beats are located at +1.25MHz from carrier.

## 3.5 Derating Performance

### 3.5.1 With Cascaded Amplifiers of Similar Distortion

Use the following procedure to determine the performance of an amplifier cascade when the amplifiers have similar distortion characteristics. All values are in dB.



**Note:** CTB and XM degrade on a voltage basis. CNR and CSO degrade on a power basis.

► **To determine the performance of an amplifier cascade**

1. Determine the number of amplifiers in cascade.
2. Refer to Section 3.5.2, *Derating Factor for Amplifiers with Similar Distortion*. Find the Voltage and Power derating factors for this number of cascaded amplifiers.
3. Subtract the Power derating factor from the CNR and CSO distortion parameters and the Voltage derating factor from the CTB and XM parameters.

**Example:** Find the distortion performance of eight amplifiers in cascade, given the amplifier parameters CTB = 102.0, CSO = 90.5, XM = 97.0, and CNR = 61.0, all in dB.

Referring to the Section 3.5.2 Derating Factor table, we find the following derating factors for eight amplifiers in cascade:

**Power:** 9.03

**Voltage:** 18.06

Subtracting the appropriate factor from each parameter results in the following values:

Output Level/ Distortion	Performance for One Amplifier	Derating Factor	Performance for Eight Amplifiers
CTB	102.0	-18.06	= 83.9
CSO	90.5	-9.03	= 81.5
XM	97.0	-18.06	= 78.9
CNR	61.0	-9.03	= 52.0

### 3.5.2 Derating Factor for Amplifiers with Similar Distortion

Use this chart with the procedure of Section 3.5 to find the distortion performance of a cascade of similar amplifiers.

All values are in dB.

# of Amps	Power (CNR/CSO)	Voltage (CTB/XM)	# of Amps	Power (CNR/CSO)	Voltage (CTB/XM)
1	0.00	0.00	26	14.15	28.30
2	3.01	6.02	27	14.31	28.63
3	4.77	9.54	28	14.47	28.94
4	6.02	12.04	29	14.62	29.25
5	6.99	13.98	30	14.77	29.54
6	7.78	15.56	31	14.91	29.83
7	8.45	16.90	32	15.05	30.10
8	9.03	18.06	33	15.19	30.37
9	9.54	19.08	34	15.31	30.63
10	10.00	20.00	35	15.44	30.88
11	10.41	20.83	36	15.56	31.13
12	10.79	21.58	37	15.68	31.36
13	11.14	22.28	38	15.80	31.60
14	11.46	22.92	39	15.91	31.82
15	11.76	23.52	40	16.02	32.04
16	12.04	24.08	41	16.13	32.26
17	12.30	24.61	42	16.23	32.46
18	12.55	25.11	43	16.33	32.67
19	12.79	25.58	44	16.43	32.87
20	13.01	26.02	45	16.53	33.06
21	13.22	26.44	46	16.63	33.26
22	13.42	26.85	47	16.72	33.44
23	13.62	27.23	48	16.81	33.62
24	13.80	27.60	49	16.90	33.80
25	13.98	27.96	50	16.99	33.98

### 3.5.3 With Cascaded Amplifiers of Dissimilar Distortion

Use the following procedure to find the performance of two amplifiers with different CNR, CSO, and/or CTB values. The performance of a cascade of amplifiers combined with another amplifier, or cascade of amplifiers, may be determined by using previously determined distortion parameters.

► **To find the performance of cascaded amplifiers of dissimilar distortion**

1. Find the difference between the same distortion parameter for two different amplifiers (*Example: CNR parameter*).
2. Determine the derating factor:
  - Use Section 3.6, *Voltage Addition Chart*, to find the derating factor for CTB and XM.
  - Use Section 3.7, *Power Addition Chart*, to find the derating factor for CNR and CSO.
3. Separate the difference value into two portions, the integer and decimal portions. (*Example: For a difference of 15.4, the integer portion = 15, the decimal portion = .4*)
4. In the appropriate table, find the required derating factor in the row of the integer portion of the difference, and in the column of the decimal portion. (*Example: for 15.4 in the Voltage Addition Chart, the derating factor is 1.36*)
5. Subtract the derating factor from the *lower* value parameter to find the performance of the two amplifiers in cascade.
6. Repeat Steps 1 to 5 for each parameter using the Power Addition Chart for CNR and CSO.

Derating Factor and Combined Performance in the table below were determined following the above procedure from the given Trunk and Bridger parameters.

	Trunk	Bridger	Derating Factor	Cascaded Performance
CSO	73.0	70.0	4.65	65.3
CNR	52.0	69.5	.14	51.9
CTB	78.9	64.0	1.44	62.6



### 3.6 Voltage Addition Chart

Use this chart to find the cascaded CTB and XM values for cascaded amplifiers. CTB and XM are voltage functions. The power ratio of two voltages is given by  $20\log(V_1/V_2)$ . All values are in dB.

Diff.	.0	.1	.2	.3	.4	.5	.6	.7	.8	.9
0	6.02	5.97	5.92	5.87	5.82	5.77	5.73	5.68	5.63	5.58
1	5.53	5.49	5.44	5.39	5.35	5.30	5.26	5.21	5.17	5.12
2	5.08	5.03	4.99	4.95	4.90	4.86	4.82	4.78	4.73	4.69
3	4.65	4.61	4.57	4.53	4.49	4.45	4.41	4.37	4.33	4.29
4	4.25	4.21	4.17	4.13	4.10	4.06	4.02	3.98	3.95	3.91
5	3.88	3.84	3.80	3.77	3.73	3.70	3.66	3.63	3.60	3.56
6	3.53	3.50	3.46	3.43	3.40	3.36	3.33	3.30	3.27	3.24
7	3.21	3.18	3.15	3.12	3.09	3.06	3.03	3.00	2.97	2.94
8	2.91	2.88	2.85	2.83	2.80	2.77	2.74	2.72	2.69	2.66
9	2.64	2.61	2.59	2.56	2.53	2.51	2.48	2.46	2.44	2.41
10	2.39	2.36	2.34	2.32	2.29	2.27	2.25	2.22	2.20	2.18
11	2.16	2.13	2.11	2.09	2.07	2.05	2.03	2.01	1.99	1.97
12	1.95	1.93	1.91	1.89	1.87	1.85	1.83	1.81	1.79	1.77
13	1.75	1.74	1.72	1.70	1.68	1.67	1.65	1.63	1.61	1.60
14	1.58	1.56	1.55	1.53	1.51	1.50	1.48	1.47	1.45	1.44
15	1.42	1.41	1.39	1.38	1.36	1.35	1.33	1.32	1.31	1.29
16	1.28	1.26	1.25	1.24	1.22	1.21	1.20	1.19	1.17	1.16
17	1.15	1.14	1.12	1.11	1.10	1.09	1.08	1.06	1.05	1.04
18	1.03	1.02	1.01	1.00	0.99	0.98	0.96	0.95	0.94	0.93
19	0.92	0.91	0.90	0.89	0.88	0.87	0.86	0.86	0.85	0.84
20	0.83	0.82	0.81	0.80	0.79	0.78	0.77	0.77	0.76	0.75
21	0.74	0.73	0.73	0.72	0.71	0.70	0.69	0.69	0.68	0.67
22	0.66	0.66	0.65	0.64	0.64	0.63	0.62	0.61	0.61	0.60
23	0.59	0.59	0.58	0.57	0.57	0.56	0.56	0.55	0.54	0.54
24	0.53	0.53	0.52	0.51	0.51	0.50	0.50	0.49	0.49	0.48
25	0.48	0.47	0.46	0.46	0.45	0.45	0.44	0.44	0.43	0.43

### 3.7 Power Addition Chart

Use this chart to find the cascaded CNR and CSO values for cascaded amplifiers. CNR and CSO are power functions. The ratio of two powers is expressed as  $10\log(P_1/P_2)$ . All values are in dB.

Diff.	.0	.1	.2	.3	.4	.5	.6	.7	.8	.9
0	3.01	2.96	2.91	2.86	2.81	2.77	2.72	2.67	2.63	2.58
1	2.54	2.50	2.45	2.41	2.37	2.32	2.28	2.24	2.20	2.16
2	2.12	2.09	2.05	2.01	1.97	1.94	1.90	1.87	1.83	1.80
3	1.76	1.73	1.70	1.67	1.63	1.60	1.57	1.54	1.51	1.48
4	1.46	1.43	1.40	1.37	1.35	1.32	1.29	1.27	1.24	1.22
5	1.19	1.17	1.15	1.12	1.10	1.08	1.06	1.04	1.01	0.99
6	0.97	0.95	0.93	0.91	0.90	0.88	0.86	0.84	0.82	0.81
7	0.79	0.77	0.76	0.74	0.73	0.71	0.70	0.68	0.67	0.65
8	0.64	0.63	0.61	0.60	0.59	0.57	0.56	0.55	0.54	0.53
9	0.51	0.50	0.49	0.48	0.47	0.46	0.45	0.44	0.43	0.42
10	0.41	0.40	0.40	0.39	0.38	0.37	0.36	0.35	0.35	0.34
11	0.33	0.32	0.32	0.31	0.30	0.30	0.29	0.28	0.28	0.27
12	0.27	0.26	0.25	0.25	0.24	0.24	0.23	0.23	0.22	0.22
13	0.21	0.21	0.20	0.20	0.19	0.19	0.19	0.18	0.18	0.17
14	0.17	0.17	0.16	0.16	0.15	0.15	0.15	0.14	0.14	0.14
15	0.14	0.13	0.13	0.13	0.12	0.12	0.12	0.12	0.11	0.11
16	0.11	0.11	0.10	0.10	0.10	0.10	0.09	0.09	0.09	0.09
17	0.09	0.08	0.08	0.08	0.08	0.08	0.07	0.07	0.07	0.07
18	0.07	0.07	0.07	0.06	0.06	0.06	0.06	0.06	0.06	0.06
19	0.05	0.05	0.05	0.05	0.05	0.05	0.05	0.05	0.05	0.04
20	0.04	0.04	0.04	0.04	0.04	0.04	0.04	0.04	0.04	0.04
21	0.03	0.03	0.03	0.03	0.03	0.03	0.03	0.03	0.03	0.03
22	0.03	0.03	0.03	0.03	0.02	0.02	0.02	0.02	0.02	0.02
23	0.02	0.02	0.02	0.02	0.02	0.02	0.02	0.02	0.02	0.02
24	0.02	0.02	0.02	0.02	0.02	0.02	0.02	0.01	0.01	0.01
25	0.01	0.01	0.01	0.01	0.01	0.01	0.01	0.01	0.01	0.01

### 3.8 Spectrum Analyzer Error Correction Chart

Use the chart on page 3-43 to correct spectrum analyzer signal measurement when the signal is within 10dB of the instrument noise floor (from the spectrum analyzer data sheet). Add the Display Error Correction to the measured value to obtain the correct value.

To measure carrier/noise ratio using a spectrum analyzer:

1. Measure the difference between the peak of sync amplitude and the noise floor.
2. The measured noise is the sum of analyzer noise and system noise. Remove the analyzer input or preamplifier input, if used, terminate, and observe the reduction in indicated noise.
3. Refer to the graph and correct the measurement in step 1 for the true carrier/noise ratio.

Example:

The indicated C/N for a system was 43 dB as per step 1 above. The noise level dropped by 5 dB when the input of the analyzer was disconnected. From the graph below it is determined that the true C/N ratio is 1.7 dB better. The true C/N is therefore 44.7 dB.

$$N + N = 10 \log_{10}(10^{\frac{A}{10}} - 1) - \Delta$$

$\Delta$  = difference between analyzer noise floor and system noise

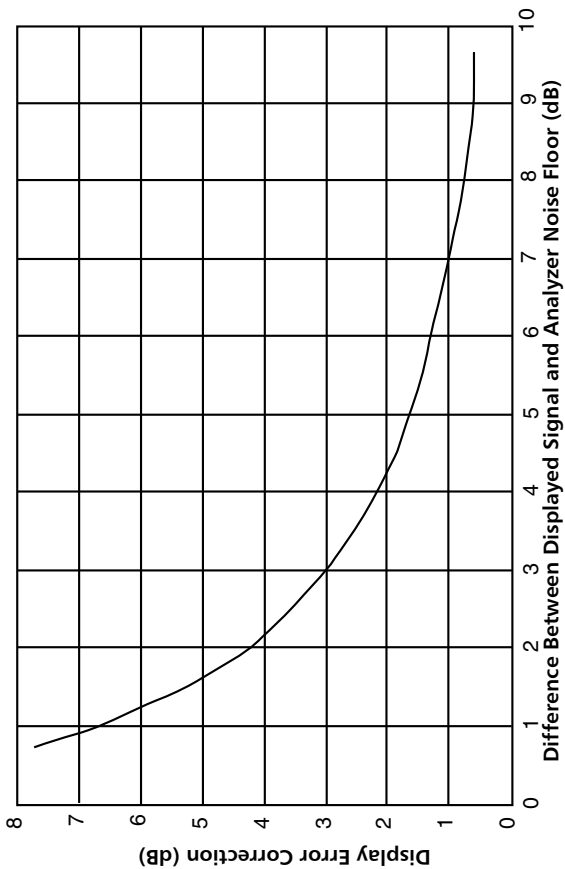

### 3.9 dBmV/Hz Bandwidth Conversion

Power per Hz is a measure of the total power within a given bandwidth (such as 1 Hz, 1 MHz, 6 MHz). This is actually a power density, or loading. To convert a known total power in one bandwidth to the total power in another bandwidth, use the following equation:

$$P_2 = P_1 + 10 \log \frac{x_2}{x_1}$$

where:

**P<sub>2</sub>** = Total power in new bandwidth

**P<sub>1</sub>** = Total power in current bandwidth

**x<sub>2</sub>** = New bandwidth

**x<sub>1</sub>** = Current bandwidth

**Examples:**

1. If a power is specified as  $-50\text{dBmV/Hz}$ , then what is the power in a 6 MHz channel?

$$x_1 = 1\text{ Hz}, x_2 = 6\text{ MHz}, P_1 = -50\text{ dBmV}$$

$$P_2 = P_1 + 10 \log \frac{6 \times 10^6}{1}$$

$$P_2 = -50 + 10(6.78)$$

$$P_2 = 17.8\text{ dBmV}$$

2. If the noise power in a 6 MHz channel is  $2.5\text{ dBmV}$ , then what is the total noise power in the 4 MHz video band?

$$x_1 = 6\text{ MHz}, x_2 = 4\text{ MHz}, P_1 = 2.5\text{ dBmV}$$

$$P_2 = P_1 + 10 \log \frac{4 \times 10^6}{6 \times 10^6}$$

$$P_2 = 2.5 + 10(-0.176)$$

$$P_2 = 0.74\text{ dBmV}$$

### 3.10 Return Loss, Reflection, and Standing Waves

Return loss is the most common measure of signal reflections (VSWR).

$$\text{Return Loss (in dB)} = 20\log\left(\frac{1}{|\Gamma|}\right)$$

The reflection coefficient is gamma ( $\Gamma$ ),  $P_r$  = reflected wave power,  $P_i$  = incident wave power.

$$\Gamma = \sqrt{\frac{P_r}{P_i}}$$

$$\text{VSWR} = \frac{1 + \Gamma}{1 - \Gamma}$$

Return Loss dB Down	Reflection Coefficient (%)	VSWR	Return Loss dB Down	Reflection Coefficient (%)	VSWR
0.0	100.0	-	8.0	39.8	2.32
0.5	94.4	34.7	8.5	37.6	2.21
1.0	89.1	17.3	9.0	35.5	2.10
1.5	84.1	11.6	9.5	33.5	2.01
2.0	79.4	8.71	10.0	31.6	1.92
2.5	75.0	7.00	10.5	29.9	1.85
3.0	70.8	5.85	11.0	28.2	1.79
3.5	66.8	5.02	11.5	26.6	1.72
4.0	63.1	4.42	12.0	25.1	1.67
4.5	59.6	3.95	12.5	23.7	1.62
5.0	56.2	3.57	13.0	22.4	1.58
5.5	53.1	3.26	13.5	21.1	1.53
6.0	50.1	3.01	14.0	20.0	1.50
6.5	47.3	2.80	14.5	18.8	1.46
7.0	44.7	2.62	15.0	17.8	1.43
7.5	42.2	2.46	15.5	16.8	1.40

Return Loss dB Down	Reflection Coefficient (%)	VSWR	Return Loss dB Down	Reflection Coefficient (%)	VSWR
16.0	15.9	1.38	24.0	6.31	1.135
16.5	15.0	1.35	24.5	5.96	1.127
17.0	14.1	1.33	25.0	5.62	1.119
17.5	13.3	1.31	25.5	5.31	1.112
18.0	12.6	1.29	26.0	5.01	1.105
18.5	11.9	1.27	26.5	4.73	1.099
19.0	11.2	1.25	27.0	4.47	1.094
19.5	10.6	1.233	27.5	4.22	1.088
20.0	10.0	1.222	28.0	3.98	1.083
20.5	9.44	1.208	28.5	3.76	1.078
21.0	8.91	1.196	29.0	3.55	1.074
21.5	8.41	1.184	29.5	3.35	1.069
22.0	7.94	1.172	30.0	3.16	1.065
22.5	7.50	1.162	30.5	2.99	1.062
23.0	7.08	1.152			
23.5	6.68	1.143			





# Maintenance and Troubleshooting

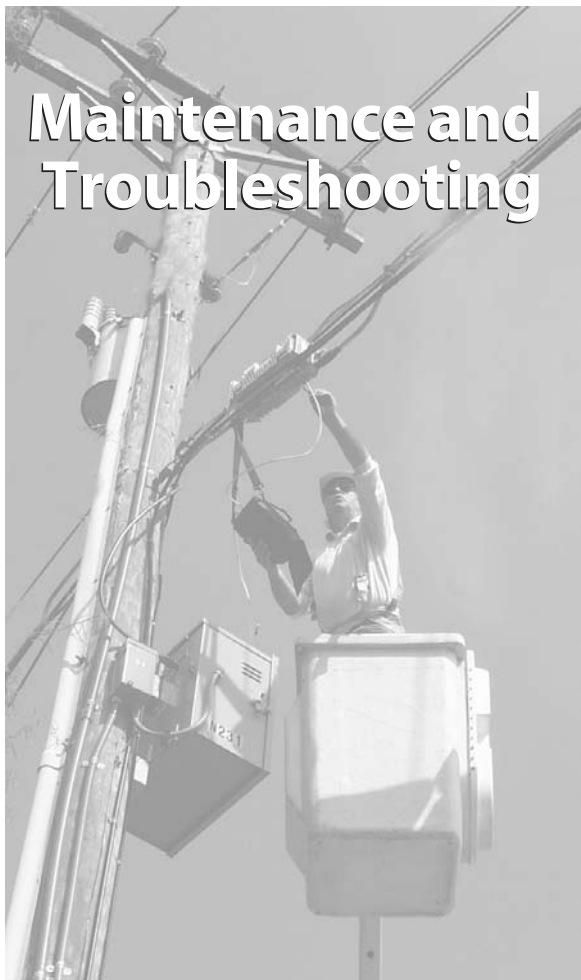

## 4.1 Cumulative Leakage Index Calculation (CLI)

Cumulative Leakage Index (CLI), also referred to as a “figure of merit” measurement, is a method for assessing the signal leakage integrity of an RF network. A quarterly signal leakage monitoring program, noting leaks of  $\geq 20 \mu\text{V}/\text{m}$  at a distance of 3 meters, must be maintained. The cable operator can demonstrate compliance with the FCC cumulative signal leakage standard by calculating the last quarter (calendar year) data with either the  $I_{3000}$  method or with the  $I_{\text{infinity}}$  method.

### 4.1.1 $I_{3000}$ Method

$$10 \log I_{3000} \leq -7$$

► *To calculate the  $I_{3000}$  method use the following procedure*

(**R** in Step 1 is the slant height distance from the leakage source to an imaginary spot 3000 meters above the center of the system).

1. Multiply the value of each leak that is  $\geq 50 \mu\text{V}/\text{m}$  by itself and divide by the square of the slant height **R**.
2. Add all these leaks together.
3. If measuring less than the entire system, divide the sum in Step 2 by the fraction of the system that was measured.
4. Find the logarithm of the number in Step 3.
5. Multiply that number by 10.
6. The resulting CLI test number should be  $\leq -7$ .

### 4.1.2 $I_{\text{infinity}}$ Method

$$10 \log I_{\infty} \leq 64$$

► *To calculate the  $I_{\text{infinity}}$  method use the following procedure*

1. Multiply the value of each leak that is  $50 \mu\text{V}/\text{m}$  or greater by itself.
2. Add all these leaks together.
3. If measuring less than the entire system, divide the sum in Step 2 by the fraction of the system that was measured.
4. Find the logarithm of the number in Step 3.
5. Multiply that number by 10.
6. A result of  $\leq 64$  is in compliance with FCC standards.

## 4.2 Maximum Leakage Field Strength Levels

The following table states, for the frequencies shown, the measured dBmV leakage levels which correspond to field strengths of 20 and 50  $\mu\text{V}/\text{m}$ .

Ch #	Visual Carrier	20 $\mu\text{V}/\text{m}$ (dBmV)	50 $\mu\text{V}/\text{m}$ (dBmV)	Ch #	Visual Carrier	20 $\mu\text{V}/\text{m}$ (dBmV)	50 $\mu\text{V}/\text{m}$ (dBmV)
14	121.2625	-42.10	-34.14	38	307.2625	-50.17	-42.22
15	127.2625	-42.52	-34.56	39	313.2625	-50.34	-42.38
16	133.2625	-42.92	-34.96	40	319.2625	-50.51	-42.55
25	229.2625	-47.63	-39.67	41	325.2625	-50.67	-42.71
26	235.2625	-47.85	-39.90	42	331.2625	-50.83	-42.87
27	241.2625	-48.07	-40.11	43	337.2625	-50.98	-43.02
28	247.2625	-48.29	-40.33	44	343.2625	-51.14	-43.18
29	253.2625	-48.50	-40.54	45	349.2625	-51.29	-43.33
30	259.2625	-48.70	-40.74	46	355.2625	-51.43	-43.48
31	265.2625	-48.90	-40.94	47	361.2625	-51.58	-43.62
32	271.2625	-49.09	-41.13	48	367.2625	-51.72	-43.76
33	277.2625	-49.28	-41.32	49	373.2625	-51.86	-43.91
34	283.2625	-49.47	-41.51	50	379.2625	-52.00	-44.04
35	289.2625	-49.65	-41.69	51	385.2625	-52.14	-44.18
36	295.2625	-49.83	-41.87	52	391.2625	-52.27	-44.31
37	301.2625	-50.00	-42.04	53	397.2625	-52.41	-44.45

Maximum leakage level may also be calculated from:

$$L = 20 \log \left[ \frac{E}{21f} \right]$$

where:

**L** = Maximum leakage level in dBmV

**E** = Voltage in  $\mu\text{V}/\text{m}$

**f** = Visual carrier frequency in MHz

### 4.3 Leakage Measurement at Different Distances

The equation for correlating signal levels from a known distance (y) to 3 meters (10 feet) is:

$$\mu\text{V/m at 10 ft} = (\mu\text{V/m at } y \text{ ft}) \times (y/10)$$

**Example:**

$$\mu\text{V/m at 10 ft} = (12.5 \mu\text{V/m at 80 ft}) \times (80/10)$$

$$\mu\text{V/m at 10 ft} = 12.5 \times 8$$

$$\mu\text{V/m at 10 ft} = 100$$

Use the following table to convert leakage measurements made at the distances listed to  $\mu\text{V/m}$  if measured 10 feet from the source.

$\mu\text{V/m}$ at 10 ft	Equivalent $\mu\text{V/m}$ when measured at:			
	15 ft	25 ft	40 ft	80 ft
20	13.33	8	5	2.50
50	33.33	20	12.5	6.25
100	66.66	40	25	12.5
200	133.33	80	50	25
300	200	120	75	37.5
400	266	160	100	50
600	400	240	150	75
800	533.33	320	200	100
1200	800	480	300	150
1500	1000	600	375	187.5

#### 4.4 Dipole Antenna Equations

A typical half-wave dipole, or Hertz, antenna is illustrated below. The radiation/reception pattern of a dipole antenna is perpendicular to the axis of the antenna. In directions parallel to the axis, both reception and radiation by this antenna are ineffective. Always orient the dipole to be broadside to a signal source. The formulas shown provide an approximate dipole length. At VHF frequencies, the dipole element diameters also affect resonant frequency.

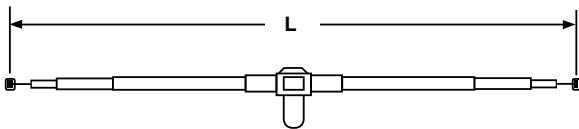

The ideal length, **L**, of a half-wave dipole antenna is given by:

$$L_{\text{feet}} = \frac{468}{\text{Frequency in MHz}}$$

$$L_{\text{meters}} = \frac{143}{\text{Frequency in MHz}}$$

## 4.5 Sweep vs. Balance

Both sweep and rough balance testing provide information about broadband signals; however, the information is different in form and purpose.

**Rough Balance** testing is limited to measuring one signal level at a time with a Signal Level Meter (SLM) at a few different frequencies within the system bandwidth. Ideally, these frequencies are the highest and lowest in the band, but may be any convenient frequencies. One is considered the “high-balancing carrier,” another the “low-balancing carrier.”

When measuring only a few carriers, you cannot see the entire bandwidth and problems may remain undetected. (See figure below.)

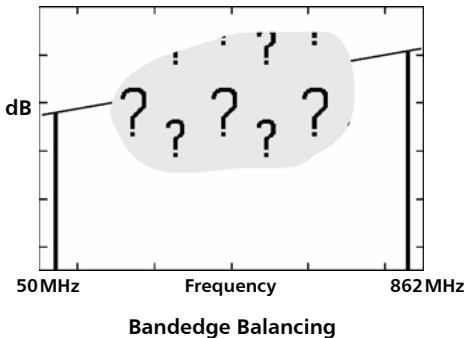

**Sweep** testing, typically performed for certification or troubleshooting, is a much more sophisticated function that requires a synchronized sweep transmitter and sweep receiver. The transmitter sends, and the receiver receives, very quick pulses on each unused frequency in the band. The receiver has a screen that displays a graph trace representing the signal pulses across the entire bandwidth of the system. The shape of this graph trace is known as the system “sweep response.” Analysis of irregularities in the signature response can be a powerful troubleshooting tool for the knowledgeable and experienced technician.

The difference between the levels at the system highest and lowest frequencies is the “tilt.” The balanced sweep with its tilt is shown on the figure below.

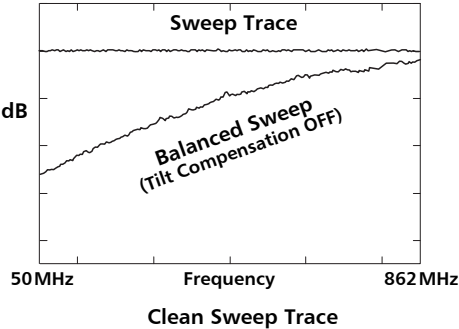

### 4.5.1 System Sweep

Sweep testing requires a field strength meter (FSM) with sweep receiver capabilities in the tested passband. The trace this meter displays is a graphical representation of the RF output level at all frequencies in the passband. It is the “sweep response” of the device or system being tested. With knowledge and experience, this signature provides a useful tool for identifying problems in a CATV network.

Contributing factors to a system’s signature include:

- The signature of the individual amplifiers used in the system (Amplifiers of the same type have similar signatures which tend to build up)
- Passives, including couplers, splitters, taps, cable and connectors, pads and equalizers
- Construction practices.

The key to sweep testing and troubleshooting lies in an understanding of the difference between normal RF cascade sweep response and abnormal peak-to-valley response. Each problem will exhibit an identifiable sweep display that, through experience, will be apparent to the technician.

When assessing the significance of signature irregularities, you can tolerate more irregularity at the end of a cascade, after signatures are built up, than at the beginning of a cascade.

**Some common system response problems and their typical causes are:**

#### **Jagged Response—**

Positive and negative spikes, closely spaced across the band, but sometimes in specific bands with smaller amplitude—often very erratic.

*Causes:* Most often caused by water damage and/or corrosion, often found in older underground cable.

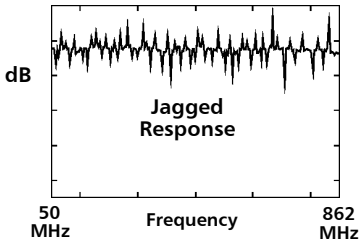



**Roll-off**—Frequency response level drop-off near the upper or lower bandedges.

Causes:

- Loose connectors or center-seizure screws
- Loose modules
- Amplifier misalignment
- Diplex filter problems
- Improper splicing such as scraping of the center conductor
- Taps, passives, or plug-in accessories in the system designed for a lower passband. (Example: 750MHz EQ in an 862MHz system).

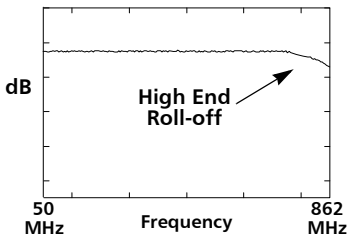

**Notch**—A sharp, often deep, negative dip.

Causes:

- Loose connectors
- Tap/coupler faceplates or amplifier modules
- Internal RF grounding problems in the amplifier.

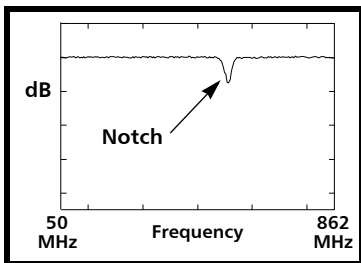

**Humping**—A signal build-up of the midband.

**Causes:** Over-equalizing amplifiers in the affected cascade, especially if equalization has been used to correct roll-off.

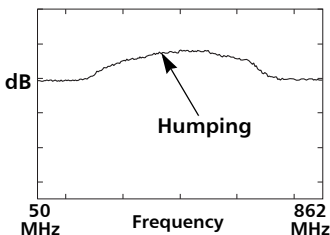

**Reflections**—Standing waves. Stable symmetrical peaks and valleys in the response, typically across the entire band but may appear only in the higher frequency region.

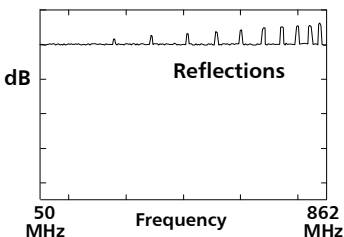

**Causes:** An impedance mismatch—a point in the signal path with an impedance of other than  $75\Omega$ . Reflections are most common in amplifiers with bi-directional testpoints.

Bi-directional testpoints are always resistive and are very useful when troubleshooting sweep response issues and fault locations. Standing waves, or reflections, in the forward sweep can be used to determine the distance **D** to a fault at the output of an amplifier with the formula:

$$D = 492(V_F/F)$$

where:

**D** = Distance to the fault (feet)

**492** = A constant factor (use **149** for distance in meters)

**V<sub>F</sub>** = Velocity factor, which is the velocity of propagation in decimal form of cable (% speed of light, 0.87 typical)

**F** = Frequency width (MHz)—the bandwidth spanned by one cycle of the standing wave



**Note:** *F* is often best measured by determining the frequency width of several standing waves, then dividing by the number of standing waves you measured.

---

## 4.6 Troubleshooting

There is no substitute for experience in troubleshooting CATV systems. However, some tips, reminders, and general information is provided in this section.

### 4.6.1 Required Equipment

- Field strength meter (FSM)
- True RMS voltmeter
- Standard technician hand tools
- Optical power meter (optional)
- Spare supplies such as, plug-in accessories, module passives, connectors
- System maps

### 4.6.2 Reminders

For each amplifier, verify the following:

- The amplifier has proper input voltage (60/90VAC)
- Raw DC
- B+ voltages
- Ripple
- ALC is on and verified
- All required accessories are properly installed
- Unused ports, ends of cables, and split points have 75Ω termination.
- Check for visible problems such as, water damage/corrosion, burnt components, blown fuses, loose or missing parts
- If using a test TV, the input testpoint to an amplifier will always display snowy pictures due to the low signal.

### 4.6.3 Service Outage Troubleshooting—Forward

System outages demand fast response and repair times.

Pinpointing a problem is made easier with good information on the outage. Information from the dispatcher or office as to exactly which areas or specific addresses are affected, and those which are not, can often enable you to pinpoint the problem to a specific power supply or amplifier without getting out of the truck.

While troubleshooting an outage, look past minor system level deviations. Do not waste time adjusting levels that are within a couple of dB while customers are without service (no picture).

In most cases, the “divide and conquer” rule works best. Establish the most distant point from the headend at which signal is verified and start midway between this point and the affected subscribers. Work forward or backward as your information dictates, always going to the middle of the identified problem cascade.

At each amplifier:

Check RF input levels at an amplifier, or the optical receiver input power at a node.

If the input is *bad*:

- Verify optical signal with a power meter.
- If there is no optical signal, the problem is either with the fiber or at the headend or hub.
- If the optical input level is correct, it is possible that there is no RF on the light. The problem is either the node optical receiver or the headend/hub transmitter.

If the input is *good*, check the RF output.

- If the RF output is *bad*, test the AC and B+ voltages.
  - If no RF, check fuses, the system power supply, or the amplifier that feeds AC to the amplifier being tested.
  - If AC OK but not B+, check main fuse and the 24V power supply.

- If AC and B+ are OK, replace the amplifier RF module. (Remove all plug-ins from the module being removed and install them in the replacement amplifier.)
- If RF is *good*, move downstream to the midpoint of the remaining problem cascade, repeating the above tests.

#### 4.6.4 Service Outage Troubleshooting—Return

Return path noise and ingress can result from:

- stationary impairments
  - thermal noise
  - intermodulation distortion
  - frequency response problems
- transient impairments
  - RF ingress
  - impulse noise
  - signal clipping
- multiplicative impairments
  - transient hum modulation
  - intermittent connections

Reducing noise and ingress in the return path should be part of a long-term maintenance plan; however, follow these procedures to troubleshoot noise and ingress in the return path.

1. Systematically check the signal level at the Return Path Receiver testpoints in the headend or hub until the problem node is determined.
2. Once the problem node is located, insert a pad (6 dB, for example) into the reverse pad location for each port of the node while monitoring the signal on a spectrum analyzer to determine on which cascade the problem lies. (The signal on the problem port/cascade will drop by 6 dB.)

3. In most cases, the “divide and conquer” rule works best. Establish the most distant point from the headend at which the signal is verified and start midway between this point and the affected subscribers. Work forward or backward as your information dictates, always going to the middle of the identified problem cascade (testing halfway through the plant, then dividing in half again, etc.) determine the problem amplifier.
4. Once the problem amplifier is isolated, continue testing to locate the suspect port. Determine if the noise or ingress is resulting from:
  - loose, corroded, or improperly installed connectors
  - damaged cabling
  - loose or improperly torqued amplifier lids
  - loose passive device faceplates
  - or loose or corroded F-port terminators.
  - Poorly shielded consumer devices may also be causing the problem.

First, repair all obvious hardware problems, including the customer drop. It may be necessary to contact the customer and inform them of the problem as they may be contributing to it. It may be necessary to use filters at the drop.



**Note:** *It may be necessary to continue to isolate the problem to a specific tap port by disconnecting individual subscriber drops from the tap until the noise/interference disappears.*

---

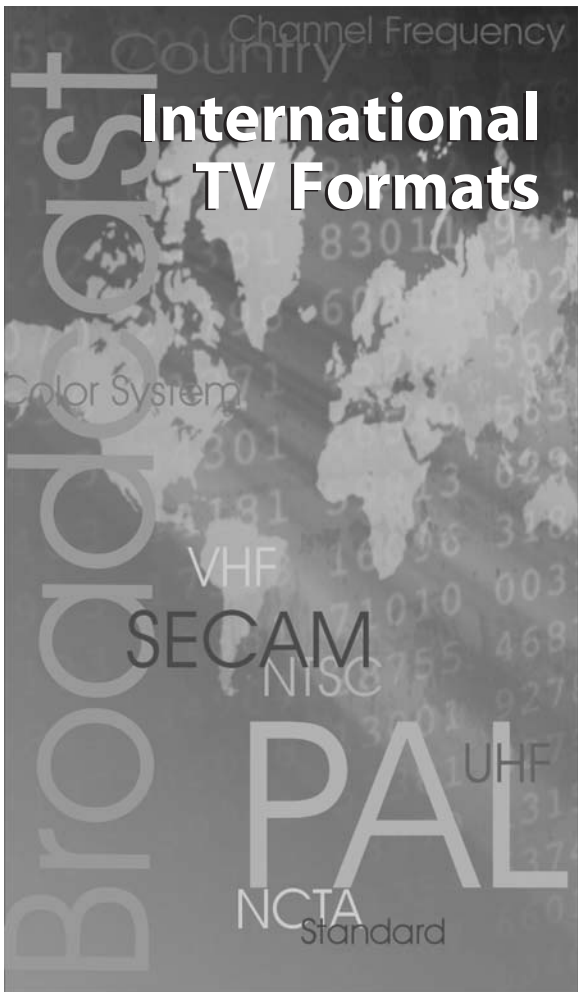

# International TV Formats

VHF  
SECAM

NISC  
PAL

UHF  
NCTA  
Standard

## 5.1 International Channel Standards

Country	Format	Broadcast Standard		Channel Freq. Standard	Std. Voltage and Cycles (Hz)	
		VHF	UHF			
Argentina	PAL	N	N	NCTA	220	50
Australia	PAL	B	G	Australian	240	50
Austria	PAL	B	G	West Euro	230	50
Bahamas	NTSC	M	—	NCTA	120	60
Belgium	PAL	B	H	West Euro	230	50
Bermuda	NTSC	M	—	NCTA	120/240	60
Bolivia	NTSC	M	N	NCTA	110/220	50
Brazil	PAL	M	M	NCTA	110/220	60
Canada	NTSC	M	M	NCTA	120	60
Chile	NTSC	M	M	NCTA	220	50
China	PAL	D	—	Chinese	220	50
Colombia	NTSC	M	M	NCTA	110	60
Costa Rica	NTSC	M	M	NCTA	120	60
Denmark	PAL	B	G	West Euro	220	50
Ecuador	NTSC	M	M	NCTA	120/220	60
Egypt	SECAM/PAL	B	G	West Euro	220	50
Finland	PAL	B	G	West Euro	220	50
France	SECAM	L	L	French	220	50
Germany	SECAM/PAL	B	G	West Euro	220	50
Greece	SECAM/PAL	B	G	West Euro	220	50
Hong Kong	PAL	—	I	West Euro	220	50
Hungary	SECAM/PAL	D	K	East Euro	220	50
India	PAL	B	—	West Euro	240	50
Indonesia	PAL	B	G	West Euro	110/220	50
Iran	SECAM	B	G	West Euro	220	50
Iraq	SECAM	B	—	West Euro	220	50
Ireland	PAL	I	I	Irish	220	50
Israel	PAL	B	G	West Euro	220	50
Italy	PAL	B	G	Italian	220	50
Japan	NTSC	M	M	Japanese	110	50/ 60
Jordan	PAL	B	G	West Euro	220	50
Korea S.	NTSC	M	M	NCTA	110	60
Kuwait	PAL	B	G	—	240	50
Malaysia	PAL	B	G	West Euro	230	50
Mexico	NTSC	M	M	NCTA	110-125	60
Morocco	SECAM	B	—	Morocco	120/220	50
Netherlands	PAL	B	G	West Euro	220	50



Country	Format	Broadcast Standard		Channel Freq. Standard	Std. Voltage and Cycles (Hz)	
		VHF	UHF			
New Zealand	PAL	B	G	NZ	240	50
Norway	PAL	B	G	West Euro	220	50
Panama	NTSC	M	M	NCTA	120	60
Peru	NTSC	M	M	NCTA	110/220	50/60
Philippines	NTSC	M	M	NCTA	110/220	60
Poland	SECAM/PAL	D	K	East Euro	220	50
Portugal	PAL	B	G	West Euro	220	50
Puerto Rico	NTSC	M	M	—	110	60
Romania	SECAM/PAL	D	K	East Euro	220	50
Russia	SECAM	D	K	East Euro	220	50
Saudi Arabia	SECAM/PAL	B	G	—	120/220	50
Singapore	PAL	B	G	West Euro	230	50
Spain	PAL	B	G	West Euro	120/220	50
Sweden	PAL	B	G	West Euro	220	50
Switzerland	PAL	B	G	West Euro	110/220	50
Taiwan	NTSC	M	—	—	110	60
Thailand	PAL	B	—	—	220	50
Turkey	PAL	B	G	—	110/220	50
United Arab Emirates	PAL	M	M	—	220/240	50
United Kingdom	PAL	I	I	West Euro	240	50
United States of America	NTSC	M	M	NCTA	110	60
Uruguay	PAL	N	—	NCTA	220	50
Venezuela	NTSC	M	—	NCTA	120/240	60

NTSC - National Television Systems Committee

PAL - Phase Alternating Line

SECAM - Système Électronique pour Couleur Avec Memoire

## 5.1.1 Broadcast Standard Letter Codes

### Broadcast Standards

Broadcast Standard	Number of Lines	Channel Width (MHz)	Visual BW (MHz)	Visual/Aural Separation (MHz)	Vestigial Sidebands (MHz)	Visual Modulation	Aural MOD
A	405	5	3.0	3.5	0.75	Pos	AM
B	625	7	5.0	5.5	0.75	Neg	FM
C	625	7	5.0	5.5	0.75	Pos	AM
D	625	8	6.0	6.5	0.75	Neg	FM
G	625	8	5.0	5.5	0.75	Neg	FM
H	625	8	5.0	5.5	1.25	Neg	FM
I	625	8	5.5	6.0	1.25	Neg	FM
K	625	8	6.0	6.5	0.75	Neg	FM
K	625	8	6.0	6.5	1.25	Neg	FM
L	625	8	6.0	6.5	1.25	Pos	AM
M	525	6	4.2	4.5	0.75	Neg	FM
N	625	6	4.2	4.5	0.75	Neg	FM

## 5.2 Channel Formats

The NTSC channel format is shown below. Refer to *International Television Standards*, on page 5-6 for parameters associated with various international channel formats.

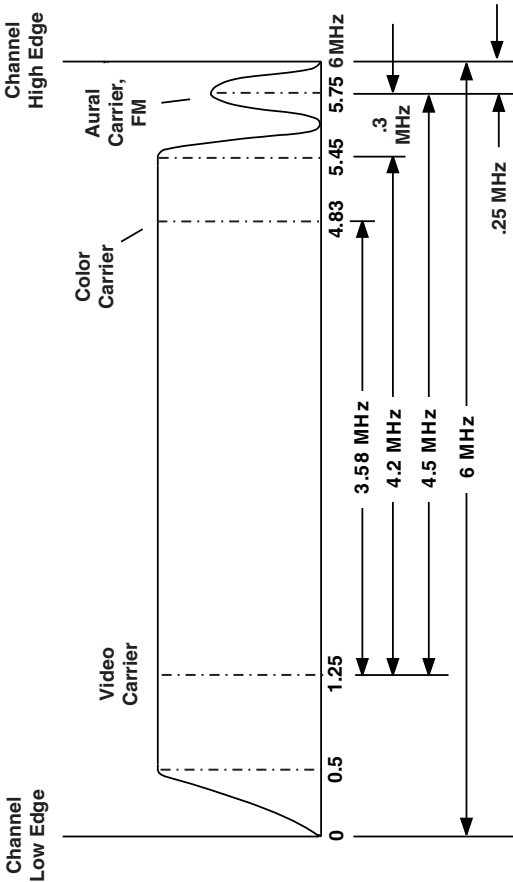

**Note:** The aural carrier amplitude level is approximately 10 to 17 dB below the visual carrier.

## International Television Standards

	NTSC	PAL B,G, H	PAL I	PAL D	PAL N	PAL M	SECAM B/H	SECAM D/K, L
Channel Width (MHz)	6	7	8	8	6	6	7	8
Video Carrier (MHz)	1.25	1.25	1.25	1.25	1.25	1.25	1.25	1.25
Color Carrier (MHz)	4.829545	5.683618	5.683618	5.683618	4.832056	4.825611	—	—
Sound Carrier (MHz)	5.75	6.75	7.25	7.75	5.75	5.75	6.75	7.75
Video Bandwidth (MHz)	4.2	5.0	5.5	6.0	4.2	4.2	5.0	6.0
Lines/Field	525/60	625/50	625/50	625/50	625/50	525/60	625/50	625/50
Horizontal Freq. (kHz)	15.734	15.625	15.625	15.625	15.625	15.75	15.625	15.625
Vertical Freq. (Hz)	60	50	50	50	50	60	50	50

### 5.3 Distortion Conversions for International TV

	550 MHz	600 MHz	750 MHz	862 MHz	Units
<b>NTSC System M</b>					
Analog Channel Spacing	6	6	6	6	MHz
Analog Channel Loading	77	85	110	129	
<b>PAL System B/G</b>					
Analog Channel Spacing	b	8	8	8	MHz
Analog Channel Loading	63	69	88	102	
CTB Conversion Factor	4	4	3	1	dB
XMOD Conversion Factor	2	2	1	1	dB
CSO Conversion Factor <sup>1</sup>	0	0	0	0	dB
<b>PAL System I, SECAM Systems D/K, and L</b>					
Analog Channel Spacing	8	8	8	8	MHz
Analog Channel Loading	60	66	85	99	
CTB Conversion Factor	3	3	3	1	dB
XMOD Conversion Factor	2	2	1	1	dB
CSO Conversion Factor <sup>2</sup>	0	0	0	0	dB
<b>CENELEC</b>					
Analog Channel Loading	—	29	35	42	
CTB Conversion Factor	—	11	12	9	dB
XMOD Conversion Factor	—	8	9	9	dB
CSO Conversion Factor <sup>2</sup>	—	4	4	6	dB

1. For output tilts greater than 8 dB, reduce CSO specification by 1 dB for each 1 dB tilt over 8 dB.
2. 7 MHz below 300 MHz, 8 MHz above 300 MHz

All specifications are subject to change without notice. Measured per NCTA test methods at 70°F.

## 5.4 Carrier Options

Use the following carrier values with distortion conversion factors provided on page 5-7.

### 5.4.1 PAL B/G Video Carriers

The PAL B/G channel plan offers the following video carriers (in MHz):

48.25	196.25	319.25	455.25	591.25	727.25
55.25	203.25	327.25	463.25	599.25	735.25
62.25	210.25	335.25	471.25	607.25	743.25
69.25	217.25	343.25	479.25	615.25	751.25
76.25	224.25	351.25	487.25	623.25	759.25
112.25	231.25	359.25	495.25	631.25	767.25
119.25	238.25	367.25	503.25	639.25	775.25
126.25	245.25	375.25	511.25	647.25	783.25
133.25	252.25	383.25	519.25	655.25	791.25
140.25	259.25	391.25	527.25	663.25	799.25
147.25	266.25	399.25	535.25	671.25	807.25
154.25	273.25	407.25	543.25	679.25	815.25
161.25	280.25	415.25	551.25	687.25	823.25
168.25	287.25	423.25	559.25	695.25	831.25
175.25	294.25	431.25	567.25	703.25	839.25
182.25	303.25	439.25	575.25	711.25	847.25
189.25	311.25	447.25	583.25	719.25	855.25

## 5.4.2 PAL I Video Carriers

The PAL I channel plan offers the following video carriers (in MHz:)

47.25	207.25	343.25	479.25	615.25	751.25
55.25	215.25	351.25	487.25	623.25	759.25
63.25	223.25	359.25	495.25	631.25	767.25
71.25	231.25	367.25	503.25	639.25	775.25
79.25	239.25	375.25	511.25	647.25	783.25
111.25	247.25	383.25	519.25	655.25	791.25
119.25	255.25	391.25	527.25	663.25	799.25
127.25	263.25	399.25	535.25	671.25	807.25
135.25	271.25	407.25	543.25	679.25	815.25
143.25	279.25	415.25	551.25	687.25	823.25
151.25	287.25	423.25	559.25	695.25	831.25
159.25	295.25	431.25	567.25	703.25	839.25
167.25	303.25	439.25	575.25	711.25	847.25
175.25	311.25	447.25	583.25	719.25	855.25
183.25	319.25	455.25	591.25	727.25	
191.25	327.25	463.25	599.25	735.25	
199.25	335.25	471.25	607.25	743.25	

### 5.4.3 NTSC System M Channel Plan

The NTSC System M Channel plan offers video carriers at 55.25, 61.25, 67.25, 77.25, 83.25, 121.25, 127.25, and every 6 MHz from 127.25 MHz to 859.25 MHz.

Available frequencies follow:

55.25	235.25	379.25	523.25	667.25	811.25
61.25	241.25	385.25	529.25	673.25	817.25
67.25	247.25	391.25	535.25	679.25	823.25
77.25	253.25	397.25	541.25	685.25	829.25
83.25	259.25	403.25	547.25	691.25	835.25
121.25	265.25	409.25	553.25	697.25	841.25
127.25	271.25	415.25	559.25	703.25	847.25
133.25	277.25	421.25	565.25	709.25	853.25
139.25	283.25	427.25	571.25	715.25	859.25
145.25	289.25	433.25	577.25	721.25	
151.25	295.25	439.25	583.25	727.25	
157.25	301.25	445.25	589.25	733.25	
163.25	307.25	451.25	595.25	739.25	
169.25	313.25	457.25	601.25	745.25	
175.25	319.25	463.25	607.25	751.25	
181.25	325.25	469.25	613.25	757.25	
187.25	331.25	475.25	619.25	763.25	
193.25	337.25	481.25	625.25	769.25	
199.25	343.25	487.25	631.25	775.25	
205.25	349.25	493.25	637.25	781.25	
211.25	355.25	499.25	643.25	787.25	
217.25	361.25	505.25	649.25	793.25	
223.25	367.25	511.25	655.25	799.25	
229.25	373.25	517.25	661.25	805.25	



#### 5.4.4 CENELEC Video Carriers

The CENELEC test channels offers the following video carriers (in MHz:)

48.25	391.25	679.25
119.25	407.25	695.25
175.25	423.25	711.25
191.25	439.25	727.25
207.25	447.25	743.25
223.25	463.25	759.25
231.25	479.25	775.25
247.25	495.25	791.25
263.25	511.25	807.25
287.25	527.25	823.25
311.25	543.25	839.25
327.25	567.25	855.25
343.25	583.25	
359.25	599.25	
375.25	663.25	





# Cable, Taps, Plug-ins, and Passives

**CommScope, Inc.**

## 6.1 Basic Cable Calculations

### 6.1.1 Cable Loss vs. Frequency

Cable attenuation doubles as frequency quadruples. For example, if a broadband signal passes through enough cable to attenuate a 54MHz signal by 5 dB, signals at 216MHz are attenuated by 10dB.

If you know the cable loss at a given frequency, you can calculate the loss at a desired frequency using the following formula:

$$L_{F_2} = L_{F_1} \sqrt{\frac{F_2}{F_1}}$$

where:

$L_{F_2}$  = Loss at the desired frequency (dB)

$L_{F_1}$  = Loss at the known frequency (dB)

$F_2$  = Desired frequency (MHz)

$F_1$  = Known frequency (MHz)

For specific frequencies, the result may be obtained without the formula by multiplying the dB loss at a Known Frequency ( $F_1$ ) by the Conversion Factor in the Known Frequency row and the Desired Frequency ( $F_2$ ) column in the table below.

### Conversion Factors

Known Frequency ( $F_1$ )—MHz	220	1	1.17	1.43	1.51	1.58	1.65	1.72	1.78	1.85	1.98
	300	0.86	1	1.22	1.29	1.35	1.41	1.47	1.53	1.58	1.70
	450	0.70	0.82	1	1.05	1.11	1.15	1.20	1.25	1.29	1.38
	500	0.66	0.77	0.95	1	1.05	1.10	1.14	1.18	1.22	1.31
	550	0.63	0.74	0.90	0.95	1	1.04	1.09	1.13	1.17	1.25
	600	0.61	0.71	0.87	0.91	0.96	1	1.04	1.08	1.12	1.20
	650	0.58	0.68	0.83	0.88	0.92	0.96	1	1.04	1.07	1.15
	700	0.56	0.65	0.80	0.85	0.89	0.93	0.96	1	1.04	1.11
	750	0.54	0.63	0.77	0.82	0.86	0.89	0.93	0.97	1	1.07
	862	0.51	0.59	0.72	0.76	0.80	0.83	0.87	0.90	0.93	1
		220	300	450	500	550	600	650	700	750	862
		Desired Frequency ( $F_2$ )—MHz									

► **To determine cable loss at a desired frequency**

1. Using the Conversion Factors chart on page 6-2, locate the Known Frequency in the column along the left side of the chart.
2. Locate the Desired Frequency along the bottom row.
3. Multiply the Conversion Factor (the number where the Known Frequency row and Desired Frequency column intersect) by the dB loss at the Known Frequency:

$$L_{F_2} = L_{F_1} \times \text{Conversion Factor}$$

**Example:** If the loss at 750MHz is 8.0dB, then the loss at 550MHz would be 8dB x 0.86, or 6.88dB.

### 6.1.2 DC Loop Resistance Calculation

The DC loop resistance and RF attenuation can be calculated at temperatures other than 68°F if the nominal resistance and attenuation at 68°F is known:

$$\text{Resistance}_{\text{DC Loop}@T} = \text{Resistance}_{\text{DC Nominal}} \left[ 1 + \left( \frac{0.022}{10^\circ\text{F}} \right) (T - 68^\circ) \right]$$

where:

**T** = ambient temperature in °F

**Resistance DC Nominal** = **Resistance DC Loop** @ 68°F

also:

$$\text{RF Attenuation Loss}@T = \text{Loss at } 68^\circ\text{F} \left[ 1 + \left( \frac{0.01}{10^\circ\text{F}} \right) (T - 68^\circ\text{F}) \right]$$

### 6.1.3 Cable Loss and Temperature Correction

---



**Note:** If the temperature is between 50°F and 90°F (10°C and 32°C), temperature correction is not required.

---

Coaxial cable loss increases with increasing temperature and decreases with decreasing temperature. To compensate for cable loss due to temperature change, you can remember that the percentage of *change* of cable loss is measured 1% for every 10°F (5.5°C) of temperature change, or you can use the Temperature Correction Value (TCV) Chart on the following page.

If the temperature is below 50°F (10°C) or above 90°F (32°C), perform temperature correction as follows:

1. In the Calculation Worksheet below, record the System Forward High and Low Balancing Carrier levels from the system map.
2. For both forward balancing carriers, note the loss (in dB at the carrier frequency) due to the cable preceding the unit under test. Also note the air temperature. Use these values and the TCV chart to obtain a TCV for this section of cable for each balancing carrier. Record both TCVs below.
3. Perform the calculation to get the corrected output levels.
4. Use the temperature-corrected forward balancing carrier levels for Forward Balancing or Forward Field Testing.
5. **Optional:** Repeat Steps 1 and 3 for the reverse balancing carriers. Use these temperature corrected levels for Reverse Balancing or Reverse Field Testing.

#### Calculation Worksheet:

<hr/>	+	<hr/>	=	<hr/>
System Forward High Balancing Carrier Level		TCV For High Carrier		Corrected Forward High Balancing Carrier Level
<hr/>	+	<hr/>	=	<hr/>
System Forward Low Balancing Carrier Level		TCV For Low Carrier		Corrected Forward Low Balancing Carrier Level

---



**Note:** The change in cable loss due to a temperature change is different at different frequencies. If the temperature changes more than 20° during balancing, recalculate the TCV.

---

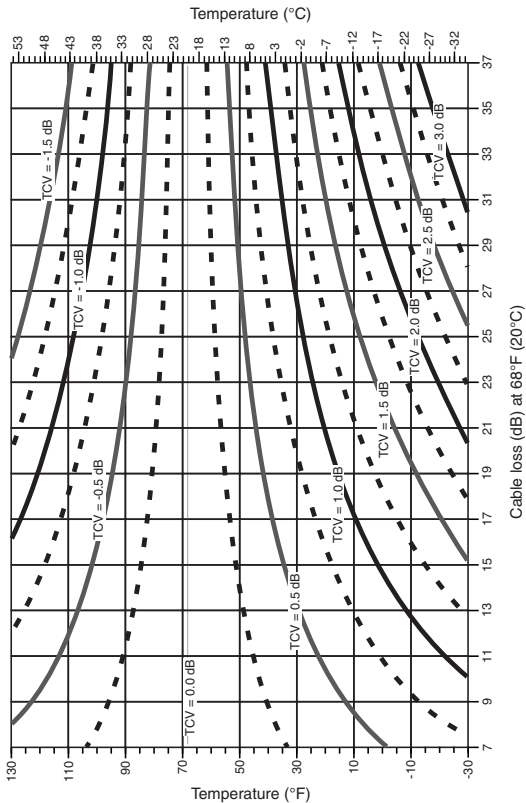

### Temperature Correction Value Chart



**Note:** To quickly obtain the TCV, find the point on the chart corresponding to your cable loss and temperature values. Then, find the TCV lines nearest this point. The dB value label on that line is your TCV.

## 6.2 Cable Specifications

### 6.2.1 Typical Coax Cable Properties

Typical losses, bending radius, and pulling tension for common types of coaxial cable are shown below.

<b>Cable Properties</b>					©SCTE
Coax	dB Loss			Bending Radius	Pulling Tension
	@30 MHz/ 100'	@50MHz/ 100'	@750MHz/ 100'		
RG59	1.45	1.78	6.78	3"	-
RG6	1.17	1.44	5.5	3"	45 lbs
320 QR	0.76	0.84	3.34	2"	120 lbs
715 QR	0.27	0.36	1.49	5"	340 lbs
750 P3	0.26	0.37	1.48	8"	675 lbs



## 6.2.2 Drop Cable

### CommScope® Drop Cable Loss

Frequency (MHz)	59 Series	6 Series	7 Series <sup>1</sup>	11 Series
	Maximum dB cable loss per 100ft / 100m at 68°F			
5	0.86/2.82	0.58/1.90	0.47/1.54	0.38/1.25
55	2.05/6.73	1.60/5.25	1.25/4.10	0.96/3.15
83	2.45/8.04	1.95/6.40	1.5/4.92	1.18/3.87
85	N/A	1.97/6.46	N/A	1.19/3.90
187	3.60/11.81	2.85/9.35	N/A	1.75/5.74
204	N/A	3.00/9.84	N/A	1.87/6.14
211	3.80/12.47	3.05/10.00	N/A	1.90/6.23
250	4.10/13.45	3.30/10.82	N/A	2.05/6.72
300	4.45/14.60	3.55/11.64	2.82/9.25	2.25/7.38
350	4.80/15.75	3.85/12.63	3.05/10.01	2.42/7.94
400	5.10/16.73	4.15/13.61	3.27/10.73	2.60/8.53
450	5.40/17.72	4.40/14.43	3.46/11.35	2.75/9.02
500	5.70/18.70	4.66/15.29	3.67/12.04	2.90/9.51
550	5.95/19.52	4.90/16.08	3.85/12.63	3.04/9.97
600	6.20/20.34	5.10/16.73		3.18/10.43
750	6.97/22.87	5.65/18.54	4.57/14.99	3.65/11.97
865	7.52/24.67	6.10/20.01	4.93/16.17	3.98/13.05
1000	8.12/26.64	6.55/21.49	5.32/17.45	4.35/14.27
1218	N/A	7.21/23.66	N/A	4.92/16.14
Vel. of Prop.	85% nominal			

1. CommScope has discontinued the 7 Series cable.

Specifications reproduced by permission. All specifications taken from manufacturer's data sheets. Contact manufacturer for more information. Attenuation increases with increasing temperature and decreases with decreasing temperature at the rate of 0.1% per °F (0.18% per °C).

## Times Fiber Communications T10 Drop Cable Loss

Frequency (MHz)	59 Series	6 Series	7 Series	11 Series
dB cable loss per 100ft / 100m at 68°F				
5	0.77/2.53	0.57/1.87	0.56/1.84	0.36/1.18
45	1.75/5.74	1.39/4.56	1.15/3.77	0.89/2.92
55	1.88/6.18	1.50/4.94	1.22/4.00	0.95/3.12
83	2.31/7.58	1.85/6.07	1.50/4.92	1.17/3.84
150	3.03/9.94	2.42/7.94	1.93/6.33	1.53/5.02
300	4.27/14.01	3.43/11.25	2.74/8.99	2.17/7.12
330	4.50/14.76	3.61/11.84	2.89/9.47	2.29/7.51
400	4.88/16.01	4.00/13.12	3.20/10.50	2.53/8.30
450	5.30/17.39	4.28/14.04	3.41/11.19	2.69/8.83
500	5.50/18.04	4.51/14.8	3.61/11.84	2.85/9.35
550	5.90/19.36	4.76/15.62	3.8/12.47	3.01/9.88
750	6.96/22.83	5.62/18.44	4.5/14.76	3.58/11.75
870	7.54/24.75	6.09/19.99	4.87/17.22	3.90/12.80
1000	8.09/26.54	6.54/21.46	5.25/17.22	4.23/13.88
Vel. of Prop.	85% nominal			

Specifications reproduced by permission. All specifications taken from manufacturer's data sheets. Contact manufacturer for more information. Attenuation increases with increasing temperature and decreases with decreasing temperature at the rate of 0.1% per °F (0.18% per °C).

<b>Copper-Clad Aluminum</b>	1.70	1.10	0.75	0.55	0.41
<b>Solid Copper</b>	—	—	—	—	—
Loop resistance at 68 °F (ohms/1000 ft); to obtain resistance in ohms/1000 m, multiply by 3.281.					

### 6.2.3 Trunk and Distribution Cable

#### CommScope Parameter III Cable Loss

Frequency (MHz)	CommScope Parameter III (P3) Cable Dia. (in)				
	0.500	0.625	0.750	0.875	1.000 <sup>1</sup>
	Maximum dB cable loss per 100ft / 100m at 68°F				
5	0.16/0.52	0.13/0.43	0.11/0.36	0.09/0.30	0.08/0.26
55	0.54/1.77	0.45/1.48	0.37/1.21	0.33/1.08	0.31/1.02
83	0.66/2.17	0.56/1.84	0.46/1.51	0.41/1.35	0.39/1.28
85	0.68/2.23	0.56/1.84	0.46/1.51	0.40/1.31	N/A
204	1.07/3.51	0.89/2.92	0.72/2.36	0.63/2.07	N/A
211	1.09/3.58	0.92/3.02	0.74/2.43	0.66/2.17	0.59/1.94
250	1.20/3.94	1.00/3.28	0.81/2.66	0.72/2.36	0.65/2.13
300	1.31/4.30	1.08/3.54	0.89/2.92	0.78/2.56	0.72/2.36
350	1.43/4.69	1.18/3.87	0.97/3.18	0.84/2.76	0.78/2.56
400	1.53/5.02	1.27/4.17	1.05/3.44	0.91/2.99	0.84/2.76
450	1.63/5.35	1.35/4.43	1.12/3.67	0.97/3.18	0.90/2.95
500	1.73/5.67	1.43/4.69	1.18/3.87	1.03/3.38	0.96/3.15
550	1.82/5.97	1.50/4.92	1.24/4.07	1.08/3.54	1.01/3.31
600	1.91/6.27	1.58/5.18	1.31/4.30	1.14/3.74	1.06/3.48
750	2.16/7.09	1.78/5.84	1.48/4.86	1.29/4.23	1.21/3.97
865	2.34/7.68	1.93/6.33	1.61/5.28	1.41/4.63	1.34/4.40
1000	2.52/8.27	2.07/6.79	1.74/5.71	1.53/5.02	1.44/4.72
1002	2.54/8.33	2.09/6.86	1.74/5.71	1.52/4.99	N/A
1218	2.83/9.28	2.32/7.61	1.95/6.40	1.70/5.58	N/A
Nominal DC Loop Resistance (ohms per 1000 ft/m) at 68°F					
Copper Clad	1.72/5.64	1.10/3.51	0.76/2.55	0.55/1.81	0.40/1.31
Solid Cop.	1.20/3.96	0.82/2.59	0.56/1.83	0.41/1.35	n/a
Vel. of Prop.	87% nominal				

1. CommScope has discontinued the P3 cable with a diameter of 1.000 inches.

Specifications reproduced by permission. All specifications taken from manufacturer's data sheets. Contact manufacturer for more information. Attenuation increases with increasing temperature and decreases with decreasing temperature at the rate of 0.1% per °F (0.18% per °C).

## CommScope Quantum Reach Cable Loss

Freq. (MHz)	CommScope Quantum Reach Cable Dia. (in)				
	0.320	0.540	0.715	0.860	1.125 <sup>1</sup>
	Maximum dB cable loss per 100ft / 100m at 68°F				
5	0.24/0.79	0.14/0.46	0.11/0.36	0.09/0.30	0.07/0.23
55	0.84/2.76	0.48/1.56	0.37/1.21	0.32/1.05	0.23/0.76
83	1.07/3.51	0.58/1.90	0.45/1.48	0.40/1.31	0.29/0.95
85	N/A	0.59/1.94	0.46/1.51	0.40/1.31	N/A
204	N/A	0.93/3.05	0.73/2.40	0.63/2.07	N/A
211	1.45/4.76	0.95/3.12	0.74/2.43	0.64//2.10	0.41/1.35
250	1.86/6.10	1.03/3.38	0.81/2.66	0.70/2.50	0.54/1.77
300	2.04/6.69	1.13/3.71	0.89/2.92	0.76/2.49	N/A
350	2.25/7.38	1.23/4.04	0.97/3.18	0.83/2.72	0.65/2.13
400	2.38/7.81	1.32/4.33	1.05/3.44	0.88/2.89	0.70/2.30
450	2.52/8.27	1.40/4.59	1.12/3.67	0.95/3.12	0.75/2.46
500	2.72/8.92	1.49/4.89	1.19/3.90	1.00/3.28	N/A
550	2.85/9.35	1.56/5.12	1.25/4.10	1.06/3.48	0.84/2.76
600	2.98/9.78	1.64/5.38	1.31/4.30	1.10/3.61	N/A
750	3.34/10.96	1.85/6.07	1.49/4.89	1.24/4.07	1.01/3.31
865	3.62/11.87	2.00/6.56	1.62/5.31	1.33/4.36	1.11/3.64
1000	3.89/12.76	2.17/7.12	1.75/5.74	1.44/4.72	1.20/3.94
1002	N/A	2.16/7.09	1.75/5.74	1.45/4.76	N/A
1218	N/A	2.41/7.91	1.96/6.43	1.61/5.28	N/A
	Nominal DC Loop Resistance (ohms per 1000 ft/m) at 68°F				
Copper Clad Alum.	4.27/14.01	1.61/5.28	0.997/3.27	0.724/2.37	0.42/1.38
Solid Cop.	3.11/10.21	1.26/4.14	0.796/2.61	0.568/1.86	n/a
Vel. of Prop.	87% nominal	88% nominal			

- CommScope has discontinued the Quantum Reach cable with a diameter of 1.125 inches.

Specifications reproduced by permission. All specifications taken from manufacturer's data sheets. Contact manufacturer for more information. Attenuation increases with increasing temperature and decreases with decreasing temperature at the rate of 0.1% per °F (0.18% per °C).

## CommScope MC<sup>2</sup> Cable Loss

Frequency (MHz)	MC <sup>2</sup> Cable Diameter (in.)				
	0.440 <sup>1</sup>	0.500	0.650	0.750	1.000 <sup>1</sup>
	Maximum dB cable loss per 100ft / 100m at 68°F				
5	0.17/0.56	0.15/0.49	0.12/0.39	0.11/0.36	0.07/0.23
30	0.41/1.35	0.35/1.15	0.28/0.92	0.25/0.82	0.18/0.59
55	0.56/1.84	0.49/1.61	0.39/1.28	0.36/1.18	0.24/0.79
83	0.69/2.26	0.61/2.00	0.48/1.57	0.43/1.41	0.30/0.98
211	1.11/3.64	0.98/3.22	0.78/2.56	0.68/2.23	0.49/1.61
250	1.21/3.97	1.06/3.48	0.85/2.79	0.75/2.46	0.54/1.77
350	1.44/4.72	1.27/4.17	1.02/3.35	0.88/2.89	0.65/2.13
450	1.64/5.38	1.44/4.72	1.17/3.84	1.00/3.28	0.74/2.43
550	1.81/5.94	1.60/5.25	1.29/4.23	1.11/3.64	0.82/2.69
750	2.13/6.99	1.88/6.17	1.54/5.05	1.29/4.23	0.97/3.18
865	2.36/7.74	2.05/6.73	1.67/5.48	1.39/4.56	1.09/3.58
1000	2.49/8.17	2.22/7.28	1.82/5.97	1.51/4.95	1.16/3.81
	Nominal DC Loop Resistance (ohms per 1000 ft/m) at 68°F				
Copper Clad Alum.	1.95/6.40	1.55/5.09	1.00/3.28	0.69/2.26	0.41/1.35
Vel. of Prop.	93% nominal				

- CommScope has discontinued the 0.440 and 1.000 inch diameter cables. The specifications for these cables are subject to change without notice.

Specifications reproduced by permission. All specifications taken from manufacturer's data sheets. Contact manufacturer for more information. Attenuation increases with increasing temperature and decreases with decreasing temperature at the rate of 0.1% per °F (0.18% per °C).

## Times Fiber T10 Semiflex Communication Cable Loss (dB/100 ft at 68°F)

Frequency (MHz)	T10 SEMIFLEX Cable Diameter (in)				
	0.500	0.625	0.750	0.875	1.000
	dB cable loss per 100ft / 100m at 68°F				
5	0.16/0.52	0.13/0.43	0.11/0.36	0.09/0.30	0.08/0.26
55	0.55/1.80	0.45/1.46	0.37/1.21	0.32/1.04	0.29/0.95
211	1.08/3.55	0.89/2.92	0.73/2.41	0.64/2.09	0.58/1.92
250	1.19/3.92	0.98/3.22	0.81/2.65	0.70/2.31	0.64/2.11
270	1.24/4.07	1.02/3.35	0.84/2.76	0.73/2.40	N/A
300	1.31/4.30	1.08/3.54	0.89/2.92	0.78/2.56	N/A
330	1.38/4.54	1.14/3.75	0.94/3.08	0.82/2.68	N/A
350	1.43/4.69	1.18/3.87	0.97/3.18	0.84/2.76	0.78/2.56
400	1.53/5.02	1.27/4.17	1.05/3.44	0.91/2.99	N/A
450	1.63/5.35	1.35/4.43	1.12/3.67	0.97/3.18	0.90/2.95
500	1.73/5.68	1.43/4.69	1.18/3.87	1.03/3.38	N/A
550	1.82/5.97	1.51/4.95	1.25/4.10	1.09/3.58	1.01/3.31
600	1.91/6.27	1.58/5.18	1.31/4.30	1.14/3.74	N/A
750	2.16/7.09	1.79/5.87	1.48/4.86	1.29/4.23	1.21/3.97
870	2.35/7.69	1.95/6.40	1.61/5.28	1.41/4.63	1.33/4.35
1000	2.53/8.30	2.11/6.92	1.74/5.71	1.53/5.02	1.44/4.72
	Nominal DC Loop Resistance (ohms per 1000 ft/m) at 68°F				
Copper-clad	1.70/5.58	1.09/3.57	0.75/2.46	0.55/1.80	0.41/1.35
Vel. of Prop.	87% nominal				

Specifications reproduced by permission. All specifications taken from manufacturer's data sheets. Contact manufacturer for more information. Attenuation increases with increasing temperature and decreases with decreasing temperature at the rate of 0.1% per °F (0.18% per °C).

## Times Fiber TX10 Semiflex Communication Cable Loss

Frequency (MHz)	TX10 SEMIFLEX Cable Diameter (in)			
	0.565	0.700	0.840	0.860
	dB cable loss per 100 ft / 100m at 68°F			
5	0.14/0.46	0.11/0.36	0.09/0.30	0.09/0.23
55	0.47/1.55	0.37/1.21	0.32/1.04	0.32/1.05
211	0.93/3.06	0.74/2.43	0.64/2.10	0.64/2.10
250	1.03/3.38	0.82/2.68	0.70/2.31	0.70/2.30
270	1.07/3.51	0.85/2.79	0.73/2.40	0.72/2.36
300	1.13/3.71	0.90/2.95	0.77/2.53	0.76/2.49
330	1.19/3.91	0.95/3.11	0.82/2.69	0.80/2.62
350	1.23/4.04	0.98/3.21	0.84/2.76	0.65/2.13
400	1.32/4.33	1.05/3.44	0.91/2.99	0.88/2.89
450	1.40/4.59	1.12/3.67	0.97/3.18	0.75/2.46
500	1.49/4.89	1.19/3.90	1.03/3.38	1.00/3.28
550	1.56/5.12	1.25/4.10	1.09/3.58	1.06/3.48
600	1.64/5.38	1.31/4.30	1.14/3.74	1.10/3.61
750	1.85/6.07	1.49/4.89	1.30/4.27	1.24/4.07
870	2.01/6.58	1.62/5.31	1.41/4.63	1.34/4.40
1000	2.17/7.12	1.75/5.74	1.53/5.02	1.44/4.72
	Nominal DC Loop Resistance (ohms per 1000 ft/m) at 68°F			
Copper-clad	1.30/4.27	0.85/2.79	0.60/1.97	0.72/2.37
Vel. of Prop.	89% nominal			

Specifications reproduced by permission. All specifications taken from manufacturer's data sheets. Contact manufacturer for more information. Attenuation increases with increasing temperature and decreases with decreasing temperature at the rate of 0.1% per °F (0.18% per °C).

<b>Copper-Clad Aluminum</b>	1.30	0.85	0.60	0.30
<b>Solid Copper</b>	—	—	—	—

To obtain resistance in ohms/1000 m, multiply by 3.281.

### 6.3 Plug-in Accessories

Plug-in accessories are used to adjust the level and “tilt” of an RF signal to produce a desired result. (Tilt is the signal level difference between the highest and lowest system frequency carriers.

Generally, the higher frequencies have more loss than the lower frequencies.) Tilt can be changed in either direction, positive or negative. Positive tilt is desired and occurs when the high frequencies have more signal level than the low frequencies.

**Cable Equalizers** compensate for the tilt produced by coaxial cable. That is, equalizers counteract the cable-induced loss in the signal by attenuating low frequency carriers more than high frequency carriers. See figure below, left.

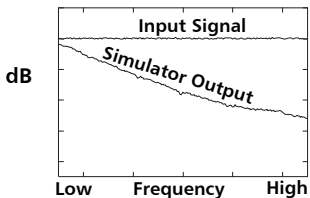
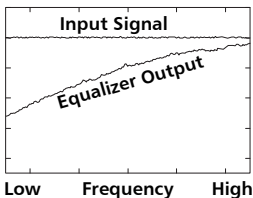

#### Equalizer and Simulator Effects on Signal

**Cable Simulators** perform the opposite function of equalizers. That is, simulators attenuate high frequency carriers more than low frequency carriers, as does cable. They are typically used when a length of cable has less than the required input “tilt” loss for a particular amplifier. See figure above, right.

**Attenuators (PADs)** attenuate (decrease) signal without regard to frequency, reducing level equally within the band for which they are rated. See figure at right.

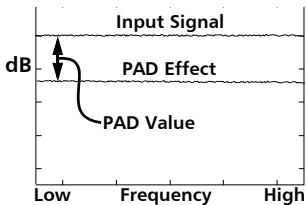

#### PAD Effects on Signal



Accessories may be used in systems with frequency the same as or lower than the accessory rating, but *not* in systems using frequencies *higher* than the accessory rating.

This means that 1 GHz accessories may be used in 862MHz system or lower frequency systems. However, the attenuation value of an 1 GHz equalizer is greater than that of the 862MHz equalizer at 862MHz and the attenuation difference narrows as the frequency approaches 0MHz. Conversely, the attenuation value of an 1 GHz cable simulator is less than that of the 862MHz cable simulator at 862MHz and the attenuation difference narrows as the frequency approaches 0MHz.



**Note:** A 862MHz accessory should not be used in an 1GHz system.

### Cable Equalizer

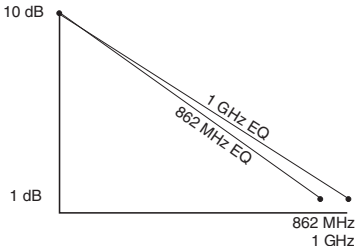

### Cable Simulator

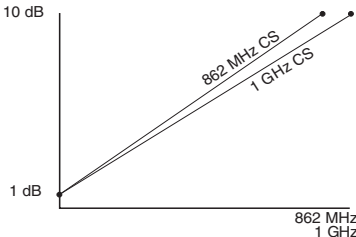

## Cable Equalizer Plug-In Module (5–1000 MHz)

Specification	Frequency (MHz)	T-EQ-2	T-EQ-4	T-EQ-6	T-EQ-8	T-EQ-10	T-EQ-12	T-EQ-14	T-EQ-16
EQ Value (dB nominal)	870	2.0	4.0	6.0	8.0	10.0	12.0	14.0	16.0
Insertion Loss (dB max)	5	3.1	4.3	6.2	7.5	9.4	11.0	12.9	14.4
	1000	0.8	0.8	0.8	0.8	0.8	1.0	1.0	1.0
Drop Insertion Loss* (dB nominal)	5	2.9	4.1	6.0	7.3	9.2	10.8	12.6	14.1
	10	2.9	4.1	6.0	7.3	9.2	10.8	12.6	14.1
	40	2.9	4.0	5.9	7.2	9.0	10.6	12.3	13.7
	50	2.8	4.0	5.9	7.1	8.9	10.5	12.2	13.6
	300	2.3	2.9	3.7	4.5	5.4	6.3	6.9	7.3
	450	1.8	2.0	2.4	3.0	3.6	4.4	4.8	5.1
	550	1.5	1.4	1.6	2.0	2.4	3.1	3.3	3.6
	750	0.9	0.7	0.8	0.9	1.2	1.7	1.7	1.9
	870	0.6	0.5	0.6	0.6	0.7	1.2	1.1	1.2
	1000	0.6	0.5	0.5	0.5	0.6	0.8	0.8	0.9
Forward Response Flatness (dB max)	-	±0.5	±0.5	±0.5	±0.5	±0.5	±0.5	±0.5	±0.5

\* The insertion loss specifications shown are in addition to the nominal tap value loss.

Specifications are subject to change without notice.

### Cable Equalizer Plug-in Module (5–1218 MHz)

Specification	Freq. (MHz)	T-EQ -2-Q	T-EQ -4-Q	T-EQ -6-EQ	T-EQ -8-Q	T-EQ -10-Q	T-EQ -12-Q	T-EQ -14-Q	T-EQ -16-Q	T-EQ -18-Q	T-EQ -20-Q	T-EQ -22-Q
EQ Value (dB nominal)	1003	2.0	4.0	6.0	8.0	10.0	12.0	14.0	16.0	18.0	20.0	22.0
Drop Insertion Loss (dB max) <sup>1</sup>	5	2.9	4.1	6.2	7.8	9.2	11.1	12.9	14.8	18.1	20.0	22.0
	50	2.9	4.1	6.1	7.6	9.1	11.0	12.5	14.5	18.1	20.0	22.0
	85	2.9	4.1	6.0	7.6	8.9	10.8	12.5	14.0	17.6	18.6	20.0
	104	2.8	4.1	5.9	7.6	8.9	10.8	11.3	14.0	17.0	18.0	19.2
	300	2.4	3.6	4.7	5.9	7.2	8.6	9.4	10.9	12.1	12.4	12.4
	450	2.1	3.0	3.7	4.6	5.6	6.6	7.0	8.3	8.9	8.9	8.9
	550	1.9	2.5	3.1	3.8	4.5	5.4	5.6	6.8	7.1	7.1	7.1
	750	1.5	1.5	2.1	2.2	2.4	3.1	3.2	4.2	4.2	4.2	4.2
	870	1.2	1.2	1.5	1.5	1.6	2.1	2.2	2.9	2.9	2.9	2.9
	1000	1.0	1.0	0.9	1.1	1.1	1.2	1.2	1.8	1.8	1.8	1.8
	1218	1.0	1.0	0.9	1.1	1.1	1.1	1.1	1.5	1.5	1.5	1.5
Fwd. Response Flatness (dB max)	—	±0.5	±0.5	±0.5	±0.7	±0.7	±0.7	±0.8	±0.9	±1.2	±1.2	±1.2

1. The insertion loss specifications shown are in addition to the nominal tap value loss.

## Cable Simulator Plug-In Module (5–1000 MHz)

Specification	Frequency (MHz)	T-CS-3 2,4,8 tap	T-CS-6 2,4,8 tap	T-CS-9 2,4 tap	T-CS-9 8 tap	T-CS-12 2,4 tap	T-CS-2 8 tap
<b>Cable Simulator Value (dB nominal)</b>	870	3.0	6.0	9.0	10.2	12.0	13.4
<b>Drop Insertion Loss* (dB max)</b>	5–108	0.5	0.5	0.5	0.5	0.5	0.5
	870	3.3	5.8	9.3	10.7	11.5	13.9
<b>Drop Insertion Loss* (dB nominal)</b>	5	0.1	0.1	0.1	0.1	0.1	0.1
	10	0.1	0.1	0.1	0.1	0.1	0.1
	40	0.1	0.1	0.1	0.1	0.1	0.1
	50	0.1	0.1	0.1	0.1	0.1	0.1
	108	0.3	0.2	0.3	0.3	0.4	0.4
	300	1.4	1.6	1.9	2.0	2.5	2.7
	450	2.1	2.9	3.7	3.9	4.7	5.2
	550	2.4	3.7	4.9	5.3	6.3	6.9
	750	2.9	5.0	7.5	8.1	9.5	11.0
	870	3.1	5.6	9.2	10.2	11.4	13.4
1000	3.3	6.1	11.2	12.1	14.3	15.1	
<b>Forward Response Flatness (dB max)</b>	–	±0.5	±0.5	±0.5	±0.5	±0.5	±0.5

\* The insertion loss specifications shown are in addition to the nominal tap value loss. Note, the insertion loss values are different for the T-CS-9 and T-CS-12 within the 2- and 4-way vs. the 8-way tap.

*Specifications are subject to change without notice.*

## Cable Simulator Plug-in Module (5–1218 MHz)

Specification	Freq. (MHz)	T-CS-2-Q	T-CS-4-Q	T-CS-6-EQ	T-CS-8-Q	T-CS-10-Q	T-CS-12-Q	T-CS-15-Q	T-CS-18-Q	T-CS-21Q
Cable Simulator Value (dB nominal)	1218	2.0	4.0	6.0	8.0	10.0	12.0	15.0	18.0	21.0
Drop Insertion Loss (dB max) <sup>1</sup>	5	0.1	0.1	0.1	0.1	0.1	0.1	0.1	0.1	0.1
	50	0.1	0.1	0.2	0.2	0.3	0.3	0.3	0.3	0.4
	85	0.2	0.2	0.3	0.3	0.5	0.6	0.6	0.7	0.9
	104	0.2	0.3	0.5	0.5	0.7	0.8	1.0	1.1	1.3
	300	0.6	1.4	1.9	2.2	3.1	3.3	3.9	4.5	5.3
	450	1.0	2.2	3.0	3.7	5.1	5.4	6.5	7.4	8.6
	550	1.3	2.7	3.7	4.7	6.3	6.8	8.1	9.4	11.0
	750	1.7	3.4	4.9	6.5	8.4	9.2	11.3	13.2	16.0
	870	1.9	3.8	5.5	7.5	9.3	10.5	13.3	15.7	18.8
	1000	2.1	4.1	6.1	8.3	10.2	11.7	14.7	18.2	21.0
	1218	2.3	4.4	6.7	9.3	11.0	12.7	15.6	19.0	21.5
Fwd. Response Flatness (dB max)	5–1003	±0.5	±0.5	±0.5	±0.5	±0.7	±0.7	±0.7	±0.8	±0.8

1. The insertion loss specifications shown are in addition to the nominal tap value loss.

## Return Path Attenuator Plug-in Module (5–1218 MHz)

Specification	Freq. (MHz)	T-RPA/ 42-2	T-RPA/ 42-4	T-RPA/ 42-6	T-RPA/ 42-8	T-RPA/ 42-10	T-RPA/ 42-12	T-RPA/ 42-14	RPA/ 42-16	T-RPA/ 42-18
Return Attenuation (dB nominal)	5–42	2.5	4.5	6.5	8.5	10.5	12.5	14.5	16.5	18.5
Tolerance	5–30	1.0	1.0	1.0	1.0	1.0	1.4	1.6	1.6	2.1
(± dB max)	31–42	2.0	2.0	2.0	2.0	2.0	2.0	2.0	2.5	2.5
Drop Insertion Loss (dB max) <sup>1</sup>	54	2.0	2.0	2.0	2.0	2.0	2.0	2.0	2.0	2.0
	100	0.3	0.3	0.3	0.3	0.3	0.3	0.3	0.3	0.3
	300	0.3	0.3	0.3	0.3	0.3	0.3	0.3	0.3	0.3
	550	0.4	0.4	0.4	0.4	0.4	0.4	0.4	0.4	0.4
	750	0.6	0.6	0.6	0.6	0.6	0.6	0.6	0.6	0.6
	870	0.7	0.7	0.7	0.7	0.7	0.7	0.7	0.7	0.7
	1000	0.7	0.7	0.7	0.7	0.7	0.7	0.7	0.7	0.7
	1218	0.9	0.9	0.9	0.9	0.9	0.9	0.9	0.9	0.9

1. The insertion loss specifications shown are in addition to the nominal tap value loss.

### Return Path Attenuator Plug-in Module (5–1218 MHz)

Specification	Freq. (MHz)	T-RPA/ 85-2	T-RPA/ 85-4	T-RPA/ 85-6	T-RPA/ 85-8	T-RPA/ 85-10	T-RPA/ 85-12	T-RPA/ 85-14	RPA/ 85-16	T-RPA/ 85-18
Return Attenuation (dB nominal)	5-85	2.0	4.0	6.0	8.0	10.0	12.0	14.0	16.0	18.0
Tolerance	5-30	1.5	1.5	1.5	1.5	1.5	1.5	1.8	2.0	2.0
(± dB max)	51-80	2.0	2.0	2.0	2.0	2.0	2.0	2.0	2.0	2.0
Drop Insertion Loss (dB max) <sup>1</sup>	104	2.2	2.2	2.2	2.2	2.2	2.2	2.2	2.2	2.2
	106	1.8	1.8	1.8	1.8	1.8	1.8	1.8	1.8	1.8
	300	0.5	0.5	0.5	0.5	0.5	0.5	0.5	0.5	0.5
	550	0.6	0.6	0.6	0.6	0.6	0.6	0.6	0.6	0.6
	750	0.7	0.7	0.7	0.7	0.7	0.7	0.7	0.7	0.7
	870	0.7	0.7	0.7	0.7	0.7	0.7	0.7	0.7	0.7
	1000	0.8	0.8	0.8	0.8	0.8	0.8	0.8	0.8	0.8
	1218	1.0	1.0	1.0	1.0	1.0	1.2	1.2	1.2	1.2

1. The insertion loss specifications shown are in addition to the nominal tap value loss.

## 6.4 RF Taps and Passives

### 6.4.1 Couplers and Splitters (9-TFC Series)

All specifications in this section reflect nominal performance for design purposes and are subject to change without notice.

<b>Philips® 9-TFC Series Directional Coupler Losses (dB)</b>				
	<b>Model</b>	<b>9-TFC-8</b>	<b>9-TFC-12</b>	<b>9-TFC-16</b>
Insertion Loss (input/output port)	5 MHz	1.7	0.9	0.7
	30 MHz	1.6	0.8	0.7
	54 MHz	1.5	0.8	0.6
	112 MHz	1.8	1.0	0.9
	330 MHz	1.8	1.0	0.9
	450 MHz	1.9	1.1	0.9
	550 MHz	2.0	1.1	0.9
	600 MHz	2.1	1.3	1.1
	750 MHz	2.4	1.5	1.2
	862 MHz	2.6	1.8	1.4
	1000 MHz	3.0	2.0	1.6
Tap Loss (input/tap port)		8.5	12.5	16.6
	5 -19 MHz			
	20-899 MHz	8.2	11.9	16.0
	900-1000 MHz	8.3	12.2	16.1



**Philips 9-TFC Series Splitter (5-1000 MHz) Losses (dB)**

	Model	9-TFC-4	9-TFC-488 <sup>1</sup>		9-TFC-777
			A	B	
			Insertion Loss (input/output port)		
	5 MHz	3.7	3.7	7.2	5.6
	30 MHz	3.5	3.7	7.1	5.5
	54 MHz	3.5	3.6	7.1	5.4
	112 MHz	3.6	3.7	7.2	5.5
	330 MHz	3.8	3.9	7.4	5.9
	400 MHz	3.8	3.9	7.4	5.9
	450 MHz	3.9	4.0	7.4	6.0
	550 MHz	4.0	4.1	7.5	6.0
	600 MHz	4.1	4.2	7.7	6.2
	750 MHz	4.3	4.5	8.0	6.5
	862 MHz	4.5	4.6	8.4	7.1
	1000 MHz	4.8	5.1	8.8	7.8

1. Value in column A refers to losses between Input and High Output. Value in column B refers to losses between Input and Low Output.

## 6.4.2 FFT\*-\*P Series 1 GHz Tap Specifications

<b>Tap Value</b>	
2-way	±1.5 dB
4-way	±1.5 dB
8-way	±2.0 dB
<b>Tap-to-Tap Isolation</b>	
5–30 MHz	20 dB
30–750 MHz	25 dB
750–1 GHz	20 dB
<b>Return Loss (Tap Ports)</b>	
10–30 MHz	16 dB
30–600 MHz	18 dB
600–1 GHz	16 dB
<b>Return Loss (In/Out Ports)</b>	
5–30 MHz	16 dB
30–600 MHz	18 dB
600–1 GHz	16 dB
<b>Power Passing</b>	
12 A maximum, 60/90 V	
<b>Hum Modulation</b>	
Low-frequency hum: 70 dB minimum at 10 A, 60/90 V	
<b>High-Frequency Transients</b>	
Hum modulation: –73 dB for input Voltage slew rates below 0.3 V/μS	
<b>RFI</b>	
90 dB	
<b>Minimum Dimensions</b>	
4.0" H x 2.9" W x 5.6" D (10.2 x 7.4 x 14.2 cm)	
<b>Weight</b>	
1 lb (0.45 kg)	

ARRIS products are designed to meet RoHS (Restriction of Hazardous Substances) Directive, which restricts the use of six hazardous materials in the manufacture of electronic and electrical equipment.

### 6.4.3 FFT\*-\*Q Series 1.2 GHz Tap Specifications

<b>Tap Value</b>	
2-way	
5–1000 Mhz	±2.0 dB
1000–1218 MHz	±2.5 dB
4-way	
5–1000 Mhz	±2.0 dB
1000–1218 MHz	±2.5 dB
8-way	
5–1000 Mhz	±3.0 dB
1000–1218 MHz	±3.5 dB
<b>Tap-to-Tap Isolation</b>	
5–9 MHz	20 dB
10–85 MHz	25 dB
86–300 MHz	27 dB
301–749 MHz	23 dB
750–1218 MHz	20 dB
<b>Return Loss (Tap Ports)</b>	
5–9 MHz	16 dB
10–749 MHz	17 dB
750–1000 MHz	17 dB
1001–1218 MHz	16 dB
<b>Return Loss (In/Out Ports)</b>	
5–9 MHz	16 dB
10–749 MHz (2-way taps)	17 dB
10–749 MHz (4- and 8-way taps)	16 dB
750–1218 MHz	16 dB
<b>Power Passing</b>	
12 A maximum, 60/90 V	
<b>Hum Modulation, 10 A</b>	
5–10 MHz	60 dB min.
11–750 MHz	65 dB min.
751–1000 MHz	60 dB min. <sup>1</sup>
1001–1218 MHz	55 dB min. <sup>1</sup>
<b>High-Frequency Transients</b>	
Hum modulation: –73 dB for input Voltage slew rates below 0.3 V/μS	
<b>RFI</b>	
100 dB min.	

---

**Minimum Dimensions**

4.0" H x 2.9" W x 5.6" D  
(10.2 x 7.4 x 14.2 cm)

**Weight**

1 lb (0.45 kg)

---

1. Hum performance can degrade 2–3 dB at 60°C.

#### 6.4.4 Regal RMT212\* Series 1.2 GHz Tap Specifications

##### Tap Value

2-way (narrow and wide)	
5–1000 Mhz	±2.0 dB
1000–1218 MHz	±2.5 dB
4-way (narrow and wide)	
5–1000 Mhz	±2.0 dB
1000–1218 MHz	±2.5 dB
8-way	
5–1000 Mhz	±3.0 dB
1000–1218 MHz	±3.5 dB

##### Tap-to-Tap Isolation

5–9 MHz	20 dB
10–85 MHz	25 dB
86–204 MHz	25 dB
205–749 MHz	23 dB
750–1218 MHz	20 dB

##### Return Loss (Tap Ports)

5–9 MHz	16 dB
10–749 MHz	16 dB
750–1000 MHz	16 dB
1001–1218 MHz	16 dB

##### Return Loss (In/Out Ports)

5–9 MHz	16 dB
10–204 MHz	16 dB
205–749 MHz	16 dB
750–1218 MHz	16 dB

##### Power Passing

12 A maximum, 60/90 V

##### Hum Modulation, 10 A

5–10 MHz	60 dB min.
11–750 MHz	65 dB min.
751–1000 MHz	60 dB min.
1001–1218 MHz	53 dB min.

##### High-Frequency Transients

Hum modulation: –73 dB for input Voltage slew rates below 0.3 V/ $\mu$ S

##### RFI

100 dB min.

---

**Minimum Dimensions**

Narrow Body: 3.75" H x 4.0" W x 3.0" D (9.53 x 10.16 x 7.62 cm)

Wide Body: 5.5" H x 4.5" W x 3.0" D (13.97 x 11.43 x 7.62 cm)

**Weight**

Narrow Body: 1 lb (0.45 kg)

Wide Body: 1.5 lb (0.68 kg)

---

## 6.4.5 BTTF\*-\*Q Power Extracting 1.2 GHz Taps Specifications

<b>Tap Value</b>	
2-way	
5–1000 Mhz	±2.0 dB
1000–1218 MHz	±2.5 dB
4-way	
5–1000 Mhz	±2.0 dB
1000–1218 MHz	±2.5 dB
8-way	
5–1000 Mhz	±3.5 dB
1000–1218 MHz	±3.8 dB
<b>Tap-to-Tap Isolation</b>	
5–9 MHz	20 dB
10–85 MHz	25 dB
86–300 MHz	27 dB
301–749 MHz	23 dB
750–1218 MHz	20 dB
<b>Return Loss (Tap Ports)</b>	
5–9 MHz	16 dB
10–749 MHz	17 dB
750–1000 MHz	17 dB
1001–1218 MHz	16 dB
<b>Return Loss (In/Out Ports)</b>	
5–9 MHz	16 dB
10–749 MHz (2-way taps)	17 dB
10–749 MHz (4- and 8-way taps)	16 dB
750–1218 MHz	16 dB
<b>Power Passing</b>	
12 A maximum, 60/90 V	
<b>Hum Modulation, 10 A<sup>1</sup></b>	
5–10 MHz	60 dB min.
11–750 MHz	65 dB min.
751–1000 MHz	60 dB min.
1001–1218 MHz	55 dB min.

---

**RFI**

100 dB min.

**Minimum Dimensions**

Wide Body: 5.5" H x 4.5" W x 3.5" D (13.97 x 11.43 x 8.89 cm)

**Weight**

Wide Body: 1.5 lb (0.68 kg)

---

1. Hum performance can degrade 2–3 dB at 60° C.



## 6.4.6 FFT\*-\*P Series 1 GHz Taps

### FFT\*-\*P Series Insertion Loss (dB) Typical Performance

	Nom. Tap Value	5 MHz	10 MHz	50 MHz	450 MHz	550 MHz	750 MHz	870 MHz	1000 MHz
FFT2-4TP	4.3	–	–	–	–	–	–	–	–
FFT2-7P	7.5	3.4	3.3	3.3	3.9	4.2	4.3	4.5	4.7
FFT2-10P	10.5	1.7	1.3	1.3	1.8	1.8	2.2	2.5	3.2
FFT2-12P	12.0	1.4	1.1	1.0	1.5	1.6	1.9	2.4	2.7
FFT2-14P	14.0	1.1	0.9	0.9	1.3	1.3	1.6	1.9	2.2
FFT2-17P	17.0	1.0	0.9	0.8	1.2	1.2	1.5	1.7	2.0
FFT2-20P	20.0	0.6	0.5	0.5	0.9	1.1	1.3	1.6	1.9
FFT2-23P	23.0	0.3	0.3	0.3	0.8	0.9	1.3	1.4	1.8
FFT2-26P	26.0	0.3	0.3	0.3	0.9	0.9	1.3	1.4	1.8
FFT2-29P	29.0	0.3	0.3	0.3	0.8	0.9	1.3	1.4	1.8
FFT4-7TP	6.8	–	–	–	–	–	–	–	–
FFT4-10P	10.3	3.3	3.3	3.3	4.0	4.1	4.3	4.5	4.2
FFT4-14P	14.4	1.6	1.3	1.3	1.9	1.9	2.4	2.6	3.2
FFT4-15.5P	15.5	1.3	1.1	1.0	1.5	1.5	1.9	2.3	2.9
FFT4-17P	17.0	1.1	0.9	1.0	1.4	1.3	1.7	2.1	2.6
FFT4-20P	20.0	0.8	0.7	0.8	1.4	1.2	1.6	1.8	2.1
FFT4-23P	23.0	0.5	0.5	0.5	1.0	1.0	1.2	1.6	1.9
FFT4-26P	26.0	0.3	0.3	0.3	0.8	0.9	1.3	1.4	1.9
FFT4-29P	29.0	0.3	0.3	0.3	0.9	0.9	1.3	1.4	1.9
FFT8-10TP	10.4	–	–	–	–	–	–	–	–
FFT8-14P	14.2	3.9	3.4	3.3	3.9	4.0	4.4	4.6	5.0
FFT8-17P	17.8	1.8	1.8	1.6	2.1	2.3	2.7	2.8	3.5
FFT8-20P	20.0	1.2	1.0	0.8	1.3	1.5	1.9	2.1	2.6
FFT8-23P	22.5	1.0	0.9	0.8	1.2	1.2	1.5	1.7	2.1
FFT8-26P	26.1	0.6	0.5	0.4	0.8	1.0	1.2	1.5	2.0
FFT8-29P	29.2	0.3	0.3	0.3	0.7	0.9	1.2	1.4	1.9

## FFT\*-\*P Series Tap to Output Isolation, Nominal

	5–10 MHz	10–50 MHz	50–450 MHz	450–600 MHz	600–750 MHz	750–1000 MHz
FFT2-4TP	–	–	–	–	–	–
FFT2-7P	15	20	25	25	20	20
FFT2-10P	18	25	25	25	22	22
FFT2-12P	20	25	23	23	23	23
FFT2-14P	24	25	30	30	27	25
FFT2-17P	27	35	33	33	30	30
FFT2-20P	30	35	40	40	40	35
FFT2-23P	30	37	40	40	40	35
FFT2-26P	36	45	45	45	40	35
FFT2-29P	39	45	45	45	40	35
FFT4-7TP	–	–	–	–	–	–
FFT4-10P	20	20	25	25	25	25
FFT4-14P	25	20	30	25	25	25
FFT4-15.5P	25	25	30	25	25	25
FFT4-17P	27	27	30	30	30	25
FFT4-20P	30	30	35	35	35	30
FFT4-23P	33	35	40	40	40	35
FFT4-26P	36	40	40	40	40	35
FFT4-29P	39	40	45	45	45	40
FFT8-10TP	–	–	–	–	–	–
FFT8-14P	20	25	25	25	25	25
FFT8-17P	23	30	30	30	30	25
FFT8-20P	30	30	35	35	35	30
FFT8-23P	30	35	35	35	35	30
FFT8-26P	38	40	40	40	40	35
FFT8-29P	40	45	45	40	40	35

## 6.4.7 FFT\*-\*Q Series 1.2 GHz Taps

### FFT\*-\*Q Series Insertion Loss (dB) Typical Performance

	Nom. Tap Value	5 MHz	10 MHz	50 MHz	100 MHz	450 MHz	550 MHz	750 MHz	870 MHz	1000 MHz	1218 MHz
FFT2-4TQ	4.0	—	—	—	—	—	—	—	—	—	—
FFT2-7Q	7.0	3.2	2.8	2.7	3.0	3.3	3.3	3.4	3.4	3.5	4.0
FFT2-10Q	10.0	1.7	1.4	1.3	1.5	1.8	2.0	2.2	2.3	2.6	2.9
FFT2-12Q	12.0	1.4	1.1	1.0	1.3	1.6	1.7	1.9	2.0	2.3	2.6
FFT2-14Q	14.0	0.9	0.7	0.6	0.8	1.1	1.2	1.3	1.4	1.6	1.9
FFT2-17Q	17.0	0.7	0.6	0.5	0.8	1.0	1.1	1.2	1.3	1.4	1.7
FFT2-20Q	20.0	0.5	0.4	0.4	0.6	0.8	0.9	1.0	1.1	1.3	1.6
FFT2-23Q	23.0	0.4	0.3	0.3	0.5	0.7	0.8	0.9	1.0	1.2	1.7
FFT2-26Q	26.0	0.4	0.3	0.3	0.5	0.7	0.8	0.9	1.0	1.2	1.6
FFT2-29Q	29.0	0.3	0.2	0.2	0.4	0.5	0.6	0.7	0.9	1.1	1.5
FFT4-7TQ	7.5	—	—	—	—	—	—	—	—	—	—
FFT4-10Q	10.8	3.8	3.3	3.2	3.5	3.9	4.0	4.2	4.1	4.1	4.6
FFT4-14Q	14.0	1.7	1.3	1.2	1.4	1.8	2.0	2.2	2.4	2.7	3.1
FFT4-15.5Q	15.5	1.3	1.0	0.9	1.2	1.5	1.7	1.9	2.1	2.3	2.7
FFT4-17Q	17.0	0.9	0.7	0.7	0.9	0.9	1.3	1.5	1.6	1.8	2.2
FFT4-20Q	20.0	0.7	0.6	0.5	0.8	0.9	1.0	1.2	1.3	1.4	1.8
FFT4-23Q	23.0	0.5	0.4	0.4	0.6	0.8	0.9	1.0	1.1	1.2	1.6
FFT4-26Q	26.0	0.4	0.3	0.3	0.5	0.7	0.7	0.8	1.0	1.1	1.5
FFT4-29Q	29.0	0.4	0.3	0.3	0.5	0.7	0.8	0.9	1.1	1.2	1.7
FFT8-10TQ	10.0	—	—	—	—	—	—	—	—	—	—
FFT8-14Q	14.5	3.7	3.3	3.2	3.4	3.9	4.0	4.1	4.1	4.1	4.5
FFT8-17Q	17.5	1.6	1.3	1.2	1.4	1.7	2.0	2.2	2.4	2.4	3.0
FFT8-20Q	20.0	1.1	0.9	0.9	1.1	1.3	1.5	1.7	1.8	1.8	2.2
FFT8-23Q	23.5	0.9	0.8	0.7	0.9	1.2	1.3	1.4	1.5	1.7	2.1
FFT8-26Q	26.0	0.6	0.5	0.5	0.7	0.8	1.0	1.1	1.2	1.3	1.7
FFT8-29Q	29.5	0.4/	0.3	0.3	0.5	0.7	0.8	0.9	1.0	1.2	1.8

## FFT\*-\*Q Series Tap to Output Isolation, Nominal

	5-9 MHz	10-85 MHz	86-300 MHz	301-749 MHz	750-899 MHz	900-1218 MHz
FFT2-4TQ	—	—	—	—	—	—
FFT2-7Q	20	25	21	22	20	20
FFT2-10Q	20	25	22	22	20	20
FFT2-12Q	22	25	23	23	22	20
FFT2-14Q	22	26	26	26	23	22
FFT2-17Q	26	30	30	30	28	25
FFT2-20Q	29	33	33	31	30	29
FFT2-23Q	32	36	36	34	33	31
FFT2-26Q	35	38	38	36	35	33
FFT2-29Q	38	40	40	39	37	35
FFT4-7TQ	—	—	—	—	—	—
FFT4-10Q	20	25	23	23	22	21
FFT4-14Q	22	27	27	27	25	24
FFT4-15.5Q	24	28	28	28	26	25
FFT4-17Q	26	28	28	28	26	25
FFT4-20Q	30	34	34	34	32	29
FFT4-23Q	32	36	36	36	34	31
FFT4-26Q	34	38	38	38	36	33
FFT4-29Q	36	40	40	40	38	35
FFT8-10TQ	—	—	—	—	—	—
FFT8-14Q	23	25	25	25	25	22
FFT8-17Q	25	30	30	30	27	25
FFT8-20Q	28	32	32	31	28	27
FFT8-23Q	30	34	34	34	32	28
FFT8-26Q	34	36	36	36	34	29
FFT8-29Q	36	38	38	37	35	31

## 6.4.8 RMT212\* Series Narrow Body Taps

### RMT212\* Insertion Loss (dB) (5-1218 MHz)

	Nom Tap Value	5 MHz Typ/Max	10 MHz Typ/Max	50 MHz Typ/Max	100 MHz Typ/Max	450 MHz Typ/Max	550 MHz Typ/Max	750 MHz Typ/Max	870 MHz Typ/Max	1000 MHz Typ/Max	1218 MHz Typ/Max
RMT2122 RF-4	4.0	—	—	—	—	—	—	—	—	—	—
RMT2122 RF-8	8.5	3.3/3.9	3.2/3.6	3.1/3.5	3.4/3.6	3.9/4.2	4.0/4.2	4.1/4.4	4.0/4.5	3.9/4.6	4.6/5.2
RMT2122 RF-11	11.5	1.7/2.0	1.3/1.8	1.2/1.8	1.5/2.0	1.8/2.4	1.9/2.4	2.2/2.6	2.4/2.9	2.6/3.2	3.0/3.6
RMT2122 RF-14	14.5	0.9/1.3	0.7/1.2	0.7/1.2	0.9/1.3	1.2/1.6	1.2/1.8	1.4/1.8	1.5/2.0	1.7/2.3	2.0/2.7
RMT2122 RF-17	17.0	0.7/1.2	0.6/1.1	0.6/1.1	0.7/1.2	1.0/1.5	1.1/1.5	1.3/1.5	1.4/1.6	1.5/1.6	1.8/2.2
RMT2122 RF-20	20.0	0.5/1.0	0.4/0.9	0.3/0.9	0.6/1.0	0.8/1.3	0.9/1.4	1.1/1.5	1.2/1.6	1.3/1.6	1.7/2.0
RMT2122 RF-23	23.5	0.3/0.7	0.3/0.6	0.3/0.7	0.5/0.8	0.7/1.1	0.8/1.2	1.0/1.3	1.1/1.4	1.3/1.6	1.6/2.0
RMT2122 RF-26	26.0	0.4/0.7	0.3/0.6	0.3/0.7	0.5/0.8	0.7/1.1	0.8/1.2	0.9/1.3	1.0/1.4	1.2/1.6	1.6/2.0
RMT2122 RF-29	29.0	0.3/0.7	0.2/0.6	0.3/0.7	0.4/0.8	0.7/1.1	0.7/1.2	0.9/1.3	1.0/1.4	1.2/1.6	1.6/2.1
RMT2124 RF-8	8.0	—	—	—	—	—	—	—	—	—	—
RMT2124 RF-11	11.5	3.4/3.9	3.3/3.6	3.2/3.5	3.5/3.6	4.0/4.2	4.0/4.4	4.1/4.5	4.0/4.6	4.0/4.7	4.8/5.3
RMT2124 RF-14	14.5	1.6/2.0	1.3/1.8	1.2/1.8	1.5/2.0	1.8/2.4	2.0/2.6	2.4/2.8	2.6/3.0	2.8/3.1	3.2/3.6
RMT2124 RF-17	17.0	0.9/1.3	0.7/1.2	0.7/1.2	0.9/1.3	1.2/1.7	1.3/1.9	1.6/1.9	1.8/2.1	1.9/2.4	2.4/2.7
RMT2124 RF-20	20.0	0.9/1.2	0.8/1.1	0.8/1.1	1.0/1.2	1.2/1.5	1.3/1.6	1.6/1.8	1.7/2.0	1.9/2.2	2.3/2.4
RMT2124 RF-23	23.0	0.5/1.0	0.4/0.9	0.4/0.9	0.6/1.0	0.8/1.3	0.9/1.4	1.1/1.5	1.3/1.6	1.4/1.7	1.8/2.0
RMT2124 RF-26	26.0	0.3/0.7	0.3/0.6	0.2/0.6	0.5/0.8	0.6/1.1	0.7/1.2	0.9/1.3	1.0/1.4	1.2/1.5	1.7/2.0
RMT2124 RF-29	29.0	0.3/0.7	0.3/0.6	0.2/0.6	0.4/0.8	0.6/1.1	0.7/1.2	0.9/1.3	1.0/1.4	1.2/1.6	1.7/2.2
RMT2128 RF-11	11.0	—	—	—	—	—	—	—	—	—	—
RMT2128 RF-14	14.5	3.7/3.9	3.3/3.6	3.2/3.5	3.4/3.7	3.7/4.2	3.8/4.4	3.8/4.5	3.8/4.5	3.7/4.5	3.8/5.2
RMT2128 RF-17	17.5	1.6/2.0	1.3/1.8	1.2/1.8	1.5/2.0	1.7/2.4	1.9/2.6	2.3/2.8	2.4/2.9	2.6/3.1	3.3/3.6
RMT2128 RF-20	20.5	1.1/1.3	0.9/1.2	0.9/1.2	1.1/1.3	1.3/1.7	1.3/1.9	1.5/1.9	1.6/2.1	1.7/2.3	2.0/2.8

## RMT212\* Insertion Loss (dB) (5-1218 MHz) (cont'd)

	Nom Tap Value	5 MHz Typ/ Max	10 MHz Typ/ Max	50 MHz Typ/ Max	100 MHz Typ/ Max	450 MHz Typ/ Max	550 MHz Typ/ Max	750 MHz Typ/ Max	870 MHz Typ/ Max	1000 MHz Typ/ Max	1218 MHz Typ/ Max
RMT2128 RF-23	23.5	0.7/ 1.1	0.6/ 0.9	0.5/ 0.9	0.7/ 1.1	0.9/ 1.3	1.0/ 1.5	1.2/ 1.6	1.2/ 1.8	1.3/ 2.0	1.6/ 2.2
RMT2128 RF-26	26.5	0.5/ 0.9	0.4/ 0.8	0.4/ 0.8	0.6/ 0.8	0.8/ 1.2	0.8/ 1.4	1.0/ 1.4	1.1/ 1.4	1.1/ 1.6	1.5/ 2.0
RMT2128 RF-29	29.5	0.4/ 0.7	0.3/ 0.6	0.3/ 0.6	0.5/ 0.6	0.7/ 1.2	0.7/ 1.2	0.9/ 1.3	1.0/ 1.5	1.1/ 1.8	1.4/ 2.3

## RMT212\* Wide Body Taps Insertion Loss (dB) (5-1218 MHz)

	Nom . Tap Val.	5 MHz Typ/ Max	10 MHz Typ/ Max	50 MHz Typ/ Max	100 MHz Typ/ Max	450 MHz Typ/ Max	550 MHz Typ/ Max	750 MHz Typ/ Max	870 MHz Typ/ Max	1000 MHz Typ/ Max	1218 MHz Typ/ Max
RMT2122W RF-4	4.0	—	—	—	—	—	—	—	—	—	—
RMT2122W- RF-8	8.5	3.8/ 3.9	3.3/ 3.6	3.2/ 3.5	3.5/ 3.6	3.8/ 4.2	3.9/ 4.3	3.9/ 4.4	3.9/ 4.5	3.8/ 4.6	4.1/ 5.2
RMT2122W RF-11	11.5	1.8/ 2.0	1.3/ 1.8	1.2/ 1.8	1.4/ 2.0	1.7/ 2.4	1.8/ 2.4	2.1/ 2.6	2.2/ 2.9	2.4/ 3.2	3.1/ 3.6
RMT2122W RF-14	14.5	0.9/ 1.3	0.8/ 1.2	0.7/ 1.2	1.0/ 1.3	1.2/ 1.6	1.2/ 1.8	1.4/ 1.8	1.5/ 2.0	1.8/ 2.3	2.2/ 2.7
RMT2122W RF-17	17.0	0.9/ 1.2	0.8/ 1.1	0.7/ 1.1	1.0/ 1.2	1.1/ 1.5	1.2/ 1.5	1.3/ 1.5	1.4/ 1.6	1.5/ 1.6	1.6/ 2.2
RMT2122W RF-20	20.0	0.5/ 1.0	0.4/ 0.9	0.4/ 0.9	0.6/ 1.0	0.8/ 1.3	0.8/ 1.4	0.9/ 1.5	1.0/ 1.6	1.1/ 1.6	1.4/ 2.0
RMT2122W RF-23	23.5	0.4/ 0.7	0.3/ 0.6	0.3/ 0.7	0.5/ 0.8	0.7/ 1.1	0.7/ 1.2	0.9/ 1.3	0.9/ 1.4	1.1/ 1.6	1.4/ 2.0
RMT2122W RF-26	26.0	0.4/ 0.7	0.3/ 0.6	0.3/ 0.7	0.6/ 0.8	0.7/ 1.1	0.7/ 1.2	0.9/ 1.3	1.0/ 1.4	1.1/ 1.6	1.4/ 2.0
RMT2122W RF-29	29.0	0.4/ 0.7	0.3/ 0.6	0.3/ 0.7	0.5/ 0.8	0.7/ 1.1	0.7/ 1.2	0.8/ 1.3	0.9/ 1.4	1.1/ 1.6	1.4/ 2.1
RMT2124W RF-8	8.0	—	—	—	—	—	—	—	—	—	—
RMT2124W RF-11	11.5	3.8/ 3.9	3.3/ 3.6	3.2/ 3.5	3.5/ 3.6	3.9/ 4.2	3.9/ 4.4	3.9/ 4.5	3.8/ 4.6	3.8/ 4.7	4.0/ 5.3
RMT2124W RF-14	14.5	1.6/ 2.0	1.3/ 1.8	1.2/ 1.8	1.4/ 2.0	1.8/ 2.4	2.0/ 2.6	2.4/ 2.8	2.6/ 3.0	2.8/ 3.1	3.3/ 3.6
RMT2124W RF-17	17.0	0.9/ 1.3	0.7/ 1.2	0.7/ 1.2	0.9/ 1.3	1.1/ 1.7	1.3/ 1.9	1.5/ 1.9	1.7/ 2.1	1.9/ 2.4	2.3/ 2.7
RMT2124W RF-20	20.0	0.7/ 1.2	0.6/ 1.1	0.5/ 1.1	0.7/ 1.2	0.9/ 1.5	1.0/ 1.6	1.2/ 1.8	1.3/ 2.0	1.4/ 2.2	1.6/ 2.4
RMT2124W RF-23	23.0	0.5/ 1.0	0.4/ 0.9	0.4/ 0.9	0.5/ 1.0	0.7/ 1.3	0.8/ 1.4	1.0/ 1.5	1.0/ 1.6	1.1/ 1.7	1.4/ 2.0
RMT2124W RF-26	26.0	0.4/ 0.7	0.3/ 0.6	0.3/ 0.6	0.5/ 0.8	0.6/ 1.1	0.7/ 1.2	0.9/ 1.3	0.9/ 1.4	1.0/ 1.5	1.3/ 2.0
RMT2124W RF-29	29.0	0.4/ 0.7	0.3/ 0.6	0.3/ 0.6	0.5/ 0.8	0.7/ 1.1	0.7/ 1.2	0.9/ 1.3	1.0/ 1.4	1.0/ 1.6	1.4/ 2.2

## RMT212\* Tap to Output Isolation (dB), nominal

	5-9 MHz	10-85 MHz	86-204 MHz	205-749 MHz	750-899 MHz	900-1218 MHz
RMT2122 (W)-RF-4	—	—	—	—	—	—
RMT2122 (W)-RF-8	20	25	21	21	20	20
RMT2122 (W)-RF-11	20	25	22	22	20	20
RMT2122 (W)-RF-14	22	26	26	26	23	22
RMT2122 (W)-RF-17	25	30	30	30	28	25
RMT2122 (W)-RF-20	29	33	33	31	30	29
RMT2122 (W)-RF-23	32	36	36	34	33	31
RMT2122 (W)-RF-26	34	38	38	36	35	33
RMT2122 (W)-RF-29	38	40	40	39	37	35
RMT2124 (W)-RF-8	—	—	—	—	—	—
RMT2124 (W)-RF-11	20	25	23	23	22	21
RMT2124 (W)-RF-14	22	27	27	27	25	24
RMT2124 (W)-RF-17	26	28	28	28	26	25
RMT2124 (W)-RF-20	29	33	33	33	32	29
RMT2124 (W)-RF-23	31	35	35	35	34	31
RMT2124 (W)-RF-26	34	37	37	37	35	32
RMT2124 (W)-RF-29	36	39	39	39	37	34
RMT2128-RF-11	—	—	—	—	—	—
RMT2128-RF-14	23	25	25	25	25	22
RMT2128-RF-17	25	30	30	30	27	25
RMT2128-RF-20	28	32	32	31	28	27
RMT2128-RF-23	30	34	34	34	32	28
RMT2128-RF-26	34	36	36	36	34	29



## RMT212\* Tap to Output Isolation (dB), nominal (cont'd)

	5-9 MHz	10-85 MHz	86-204 MHz	205-749 MHz	750-899 MHz	900-1218 MHz
RMT2128- RF-29	36	38	38	37	35	31

## 6.4.9 BTF\*-\*Q 1.2 GHz Power Extracting Taps

BTF\*-\*Q F-Port Power Extracting Taps Insertion Loss (dB)<sup>1</sup> (5-1218 MHz)

Nom. Tap Value	5 MHz		10 MHz		50 MHz		100 MHz		450 MHz		550 MHz		750 MHz		870 MHz		1000 MHz		1218 MHz		
	Typ/Max	Typ/Max	Typ/Max	Typ/Max	Typ/Max	Typ/Max	Typ/Max	Typ/Max	Typ/Max	Typ/Max	Typ/Max	Typ/Max	Typ/Max	Typ/Max	Typ/Max	Typ/Max	Typ/Max	Typ/Max	Typ/Max	Typ/Max	
BTF2-4TQ	4.0	—	—	—	—	—	—	—	—	—	—	—	—	—	—	—	—	—	—	—	
BTF2-7Q	7.0	*/4.1	*/3.8	*/3.7	*/3.8	*/4.3	*/4.4	*/4.4	*/4.4	*/4.4	*/4.4	*/4.4	*/4.4	*/4.4	*/4.4	*/4.4	*/4.4	*/4.5	*/4.5	*/5.4	
BTF2-10Q	10.0	*/2.2	*/1.9	*/1.9	*/2.2	*/2.5	*/2.5	*/2.6	*/2.7	*/2.7	*/2.7	*/2.7	*/2.7	*/2.7	*/2.7	*/2.7	*/2.7	*/3.0	*/3.2	*/3.8	
BTF2-12Q	12.0	*/1.9	*/1.8	*/1.8	*/2.1	*/2.2	*/2.2	*/2.5	*/2.6	*/2.6	*/2.6	*/2.6	*/2.6	*/2.6	*/2.6	*/2.6	*/2.6	*/2.9	*/3.2	*/3.8	
BTF2-14Q	14.0	*/1.5	*/1.4	*/1.4	*/1.5	*/1.8	*/1.8	*/2.0	*/2.1	*/2.1	*/2.1	*/2.1	*/2.1	*/2.1	*/2.1	*/2.1	*/2.1	*/2.3	*/2.5	*/2.9	
BTF2-17Q	17.0	*/1.4	*/1.3	*/1.3	*/1.5	*/1.7	*/1.7	*/1.8	*/1.8	*/1.8	*/1.8	*/1.8	*/1.8	*/1.8	*/1.8	*/1.8	*/1.8	*/1.8	*/1.8	*/1.8	*/2.4
BTF2-20Q	20.0	*/1.2	*/1.1	*/1.1	*/1.3	*/1.5	*/1.5	*/1.6	*/1.7	*/1.7	*/1.7	*/1.7	*/1.7	*/1.7	*/1.7	*/1.7	*/1.7	*/1.8	*/1.8	*/2.2	
BTF2-23Q	23.0	*/0.9	*/0.8	*/0.9	*/1.0	*/1.2	*/1.2	*/1.4	*/1.5	*/1.5	*/1.5	*/1.5	*/1.5	*/1.5	*/1.5	*/1.5	*/1.5	*/1.8	*/1.8	*/2.2	
BTF2-26Q	26.0	*/0.8	*/0.8	*/0.9	*/0.9	*/1.4	*/1.4	*/1.5	*/1.5	*/1.5	*/1.5	*/1.5	*/1.5	*/1.5	*/1.5	*/1.5	*/1.5	*/1.8	*/1.8	*/2.2	
BTF2-29Q	29.0	*/0.8	*/0.8	*/0.9	*/0.9	*/1.4	*/1.4	*/1.5	*/1.5	*/1.5	*/1.5	*/1.5	*/1.5	*/1.5	*/1.5	*/1.5	*/1.5	*/1.8	*/1.8	*/2.2	
BTF4-7TQ	7.2	—	—	—	—	—	—	—	—	—	—	—	—	—	—	—	—	—	—	—	
BTF4-10Q	10.0	*/4.0	*/3.8	*/3.7	*/3.8	*/4.4	*/4.4	*/4.6	*/4.6	*/4.6	*/4.6	*/4.6	*/4.6	*/4.6	*/4.6	*/4.6	*/4.6	*/4.6	*/4.6	*/5.4	
BTF4-14Q	14.0	*/2.2	*/2.0	*/1.9	*/2.2	*/2.5	*/2.5	*/2.7	*/2.9	*/2.9	*/2.9	*/2.9	*/2.9	*/2.9	*/2.9	*/2.9	*/2.9	*/3.1	*/3.2	*/3.8	
BTF4-15.5Q	15.5	*/1.8	*/1.6	*/1.6	*/1.8	*/2.0	*/2.0	*/2.1	*/2.5	*/2.5	*/2.5	*/2.5	*/2.5	*/2.5	*/2.5	*/2.5	*/2.5	*/2.8	*/3.2	*/3.6	
BTF4-17Q	17.0	*/1.5	*/1.4	*/1.4	*/1.7	*/1.8	*/1.8	*/2.0	*/2.0	*/2.0	*/2.0	*/2.0	*/2.0	*/2.0	*/2.0	*/2.0	*/2.0	*/2.3	*/2.6	*/2.9	
BTF4-20Q	20.5	*/1.4	*/1.3	*/1.2	*/1.4	*/1.6	*/1.6	*/1.8	*/1.8	*/1.8	*/1.8	*/1.8	*/1.8	*/1.8	*/1.8	*/1.8	*/1.8	*/2.0	*/2.2	*/2.4	
BTF4-23Q	23.0	*/1.2	*/1.0	*/1.0	*/1.1	*/1.4	*/1.4	*/1.5	*/1.6	*/1.6	*/1.6	*/1.6	*/1.6	*/1.6	*/1.6	*/1.6	*/1.6	*/1.9	*/1.9	*/2.2	
BTF4-26Q	26.0	*/0.9	*/0.7	*/0.7	*/0.9	*/1.0	*/1.0	*/1.2	*/1.4	*/1.4	*/1.4	*/1.4	*/1.4	*/1.4	*/1.4	*/1.4	*/1.4	*/1.9	*/2.0	*/2.2	
BTF4-29Q	29.0	*/0.9	*/0.7	*/0.7	*/0.9	*/1.0	*/1.0	*/1.2	*/1.4	*/1.4	*/1.4	*/1.4	*/1.4	*/1.4	*/1.4	*/1.4	*/1.4	*/1.9	*/2.0	*/2.2	
BTF8-10TQ	10.0	—	—	—	—	—	—	—	—	—	—	—	—	—	—	—	—	—	—	—	
BTF8-14Q	14.2	*/4.0	*/3.8	*/3.7	*/3.9	*/4.5	*/4.5	*/4.7	*/4.7	*/4.7	*/4.7	*/4.7	*/4.7	*/4.7	*/4.7	*/4.7	*/4.7	*/4.7	*/4.7	*/5.4	
BTF8-17Q	17.8	*/2.2	*/2.0	*/2.0	*/2.1	*/2.6	*/2.6	*/2.7	*/3.0	*/3.0	*/3.0	*/3.0	*/3.0	*/3.0	*/3.0	*/3.0	*/3.0	*/3.1	*/3.3	*/3.8	
BTF8-20Q	20.0	*/1.5	*/1.4	*/1.4	*/1.4	*/1.9	*/1.9	*/2.1	*/2.1	*/2.1	*/2.1	*/2.1	*/2.1	*/2.1	*/2.1	*/2.1	*/2.1	*/2.3	*/2.5	*/3.0	
BTF8-23Q	23.5	*/1.3	*/1.1	*/1.1	*/1.4	*/1.5	*/1.5	*/1.7	*/1.8	*/1.8	*/1.8	*/1.8	*/1.8	*/1.8	*/1.8	*/1.8	*/1.8	*/2.0	*/2.2	*/2.4	
BTF8-26Q	26.1	*/1.0	*/0.9	*/0.9	*/1.0	*/1.2	*/1.2	*/1.4	*/1.6	*/1.6	*/1.6	*/1.6	*/1.6	*/1.6	*/1.6	*/1.6	*/1.6	*/1.8	*/1.8	*/2.2	
BTF8-29Q	29.2	*/1.0	*/0.9	*/0.9	*/1.0	*/1.2	*/1.2	*/1.4	*/1.6	*/1.6	*/1.6	*/1.6	*/1.6	*/1.6	*/1.6	*/1.6	*/1.6	*/1.8	*/1.8	*/2.2	

**NOTE:1.** The BTF\*-\*Q is shipped standard with a jumper (F-JP) installed into the plug-in module sockets.

### BTF\*-\*Q Tap to Output Isolation, dB nominal (5-1218 MHz)

	5-9 MHz	10-85 MHz	86-300 MHz	301-749 MHz	750-899 MHz	900-1218 MHz
BTF2-4TQ	—	—	—	—	—	—
BTF2-7Q	20	25	21	22	20	20
BTF2-10Q	20	25	22	22	20	20
BTF2-12Q	22	25	23	23	22	20
BTF2-14Q	22	26	26	26	22	22
BTF2-17Q	26	28	30	30	28	25
BTF2-20Q	26	33	33	31	30	28
BTF2-23Q	26	35	35	34	32	30
BTF2-26Q	26	38	38	36	35	30
BTF2-29Q	26	38	38	38	35	33
BTF4-7TQ	—	—	—	—	—	—
BTF4-10Q	20	25	23	23	22	20
BTF4-14Q	22	27	27	27	25	24
BTF4-15.5Q	24	28	28	28	26	25
BTF4-17Q	26	28	28	28	26	25
BTF4-20Q	30	34	34	34	32	28
BTF4-23Q	32	35	35	35	34	39
BTF4-26Q	34	38	38	38	35	33
BTF4-29Q	35	40	40	40	36	35
BTF8-10TQ	—	—	—	—	—	—
BTF8-14Q	20	25	25	25	24	24
BTF8-17Q	25	30	30	30	27	25
BTF8-20Q	30	34	34	34	32	29
BTF8-23Q	32	35	35	35	34	31
BTF8-26Q	34	38	38	38	36	33
BTF8-29Q	36	38	38	38	38	35

## 6.4.10 SSP-\*N Series System Passives

### Insertion Loss (dB)

	5 MHz Typ/ Max	10 MHz Typ/ Max	50 MHz Typ/ Max	450 MHz Typ/ Max	550M Hz Typ/ Max	750M Hz Typ/ Max	870 MHz Typ/ Max	1000 MHz Typ/ Max
SSP-N								
PIN	0.3\0.5	0.2/0.4	0.2/0.4	0.2/0.4	0.3/0.5	0.4/0.6	0.5/0.7	0.7/1.1
3N	3.9/4.2	3.7/3.9	3.6/3.8	3.9/4.3	4.0/4.4	4.3/4.6	4.6/4.9	5.1/5.5
	3.9/4.2	3.7/3.9	3.6/3.8	3.9/4.3	4.0/4.4	4.3/4.6	4.6/4.9	5.1/5.5
7N	2.0/2.3	1.8/2.0	1.7/1.9	2.2/2.4	2.4/2.6	2.8/3.0	3.2/3.4	3.9/4.2
	7.3/7.5	7.3/7.5	7.3/7.5	7.7/7.5	7.6/7.8	7.9/8.1	8.1/8.4	8.3/8.6
9N	1.5/1.8	1.3/1.5	1.2/1.4	1.6/1.8	1.7/2.0	2.1/2.2	2.4/2.5	2.8/3.0
	9.2/9.5	9.1/9.3	9.2/9.4	9.0/9.2	9.1/9.3	9.3/9.3	9.7/9.9	10.0/ 10.3
12N	1.1/1.4	1.0/1.2	1.0/1.2	1.3/1.5	1.4/1.6	1.6/1.8	1.8/2.0	2.0/2.4
	11.7/ 12.0	11.4/ 11.6	11.4/ 11.6	11.5/ 11.7	11.6/ 11.8	12.0/ 12.2	12.5/ 12.7	13.2/ 13.5
	16N	1.0/1.2	0.9/1.1	0.8/1.1	1.1/1.2	1.3/1.5	1.5/1.7	1.7/1.9
3-636N	15.9/ 16.2	15.5/ 15.7	15.5/ 15.7	15.4/ 15.6	15.6/ 15.8	16.0/ 16.2	16.6/ 16.8	16.9/ 17.2
	7.1/7.5	7.0/7.2	7.0/7.2	7.6/7.8	7.7/7.9	8.1/8.3	8.7/8.9	9.7/ 10.0
	7.1/7.5	7.0/7.2	7.0/7.2	7.3/7.5	7.4/7.6	7.8/8.0	8.4/8.6	9.5/ 10.0
	3.8/4.2	3.6/3.8	3.6/3.8	4.0/4.2	4.1/4.3	4.5/4.7	4.7/5.1	5.4/5.8

#### Passband

5–1000 MHz

#### Current Handling

(power inserter)

#### SSP-PIN

Input 20 A max.

Output 15 A max.

#### Terminal Match (dB min.)

5–30 16

30–750 18

750–1000 18

#### RF/AC Isolation

(power inserter) (dB)

5–10 60

10–870 55

870–1000 50

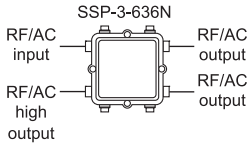
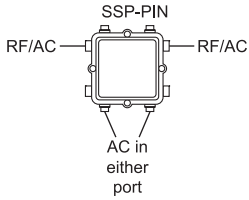
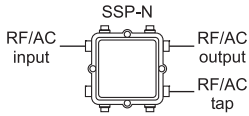

## 6.4.11 SSP-\*Q Series 1.2 GHz Passives

### Insertion Loss (dB)

		5–150 MHz Typ/ Max	151– 450 MHz Typ/ Max	451– 600 MHz Typ/ Max	601– 750 MHz Typ/ Max	751– 850 MHz Typ/ Max	851– 1000 MHz Typ/ Max	1001– 1218 MHz Typ/ Max
SSP-PIQ and SSP-PIQ/SP		0.3/ 0.6	0.4/ 0.6	0.4/ 0.7	0.4/ 0.8	0.4/ 0.9	0.5/ 1.1	0.9/ 1.6
SSP-3Q		3.8/ 4.4	3.8/ 4.4	3.9/ 4.6	4.1/ 5.0	4.3/ 5.2	4.5/ 5.5	5.0/ 6.3
SSP-7Q	Output	1.9/ 2.7	2.1/ 2.7	2.1/ 3.0	2.4/ 3.3	2.6/ 3.6	2.8/ 4.0	3.4/ 4.2
	Tap Loss	7.7/ 8.0	7.6/ 8.0	7.5/ 8.2	7.5/ 8.5	7.6/ 8.7	7.9/ 9.0	8.5/ 9.7
SSP-9Q	Output	1.4/ 1.8	1.6/ 2.0	1.6/ 2.3	1.8/ 2.7	2.1 /3.0	2.3/ 3.3	2.9/ 3.6
	Tap Loss	9.3/ 9.9	9.2/ 9.7	9.1/ 9.9	9.1/ 10.1	9.1/ 10.3	9.4/ 10.6	10.0/ 11.2
SSP- 12Q	Output	1.1/ 1.5	1.3/ 1.7	1.4/ 2.0	1.5/ 2.2	1.6/ 2.4	1.8/ 2.7	2.2/ 3.0
	Tap Loss	11.7/ 12.8	11.4/ 12.5	11.4/ 12.5	11.5/ 12.8	11.6/ 13.2	11.9/ 13.6	12.7/ 14.2
SSP- 16Q	Output	0.9/ 1.3	1.0/ 1.5	1.0/ 1.7	1.1/ 1.9	1.3/ 2.2	1.5/ 2.4	1.9/ 2.8
	Tap Loss	15.7/ 16.8	15.4/ 16.5	15.3/ 16.5	15.4/ 16.7	15.5/ 16.9	15.9/ 17.3	16.6/ 17.7
SSP-3- 636Q	J1-J2	7.2/ 7.9	7.5/ 8.2	7.5/ 8.5	7.6/ 9.0	7.7/ 9.6	7.9/ 10.3	8.8/ 11.0
	J1-J3	7.2/ 7.9	7.5/ 8.2	7.5/ 8.5	7.6/ 9.0	7.7/ 9.6	7.9/ 10.3	8.8/ 11.0
	J1-J4	3.9/ 4.6	4.0/ 4.5	4.1/ 4.7	4.2/ 4.9	4.2/ 5.3	4.4/ 5.7	4.9/ 6.3

#### Passband

5–1218 MHz

#### Current Handling

(power inserter)

#### SSP-PIN

Input 20 A max.

Output 15 A max.

#### Terminal Match (dB min.)

5–30 16

30–750 18

750–1000 18

#### RF/AC Isolation

(power inserter) (dB)

5–10 60

10–870 55

870–1000 50

## 6.4.12 Regal RL\*/RPI\* Series 1.2 GHz Passives

### Insertion Loss (dB)

	5-10 MHz		11-450 MHz		451-600 MHz		601-750 MHz		751-850 MHz		851-1000 MHz		1001-1218 MHz	
	Typ/Max	MHz	Typ/Max	MHz	Typ/Max	MHz	Typ/Max	MHz	Typ/Max	MHz	Typ/Max	MHz	Typ/Max	MHz
RPI-120(SP) 20A-90	0.5/		0.75/		0.8/		0.8/		0.8/		1.1/		1.6/	
	1.1		1.2		1.2		1.6		1.6		1.6		1.8	
RLS12-2(SP)-15A	4.1/		4.2/		4.4/		4.5/		4.6/		5.0/		6.0/	
	4.8		4.6		4.8		5.3		5.3		6.1		6.6	
RLS12-3B(SP)-15A	6.0/		6.1/		6.2/		6.4/		6.6/		7.2/		8.2/	
	6.4		7.1		7.3		7.8		7.8		7.8		8.4	
RLS12-3(SP)-15A	3.8/		4.0/		4.2/		4.3/		4.4/		4.6/		5.4/	
	4.7		4.7		5.2		5.6		5.6		6.0		6.5	
Port 3, 4	7.8/		7.2/		7.3/		7.5/		7.7/		7.9/		9.0/	
	8.2		8.3		8.5		9.0		9.0		9.5		10.0	
RLDC12-8(SP)-15A	2.1/		2.4/		2.5/		2.5/		2.7		3.0/		3.6/	
	2.5		2.9		3.2		3.5		/3.5		4.1		4.4	
Tap Loss	7.8/		7.8/		7.8/		7.9/		8.1/		8.6/		9.4/	
	8.0		8.0		8.2		8.5		8.7		9.0		9.7	
RLDC12-12(SP)-15A	1.7/		1.6/		1.8/		1.9/		1.9/		2.7/		3.5/	
	2.0		2.0		2.3		2.9		2.9		3.7		4.3	
Tap Loss	12.2		11.7		11.7		11.7		11.8		12.7		14.1	
	12.8		12.5		12.5		12.8		13.2		13.6		14.5	
RLDC12-16(SP)-15A	1.1/		1.2/		1.3/		1.4/		1.5/		1.7/		2.4/	
	1.7		1.8		2.2		2.3		2.9		3.7		4.3	
Tap Loss	16.3		15.8		15.7		15.6		15.7		16.4		17.5	
	16.8		16.5		16.5		16.8		17.2		17.6		18.2	

### Isolation (dB)

	5-10 MHz	11-300 MHz	301-850 MHz	851-1000 MHz	1001-1218 MHz
RPI-120(SP)-20A-90V	60	60	60	60	57
RLS12-2(SP)-15A	20	20	20	20	20
RLS12-3B(SP)-15A	20	20	20	20	20
RLS12-3(SP)-15A	20	20	20	20	20
RLDC12-8(SP)-15A	20	20	20	20	20
RLDC12-12(SP)-15A	20	20	20	20	20
RLDS12-16(SP)-15A	20	20	20	20	20



## 6.4.13 12-TFC/17A Series 1.2 GHz Line Passives

### Insertion Loss (dB Maximum)

	5-10 MHz	11-85 MHz	86-550 MHz	551-870 MHz	871-1000 MHz	1001-1218 MHz
12-LPI/22A and 12-LPI/22A-ACM-3	1.0	0.6	0.9	1.2	1.6	2.0
12-TFC-4/17A	3.9	4.1	4.5	5.2	5.7	6.6
12-TFC-8/17A	1.9	1.9	2.3	3.1	3.5	4.1
Tap Loss	9.5	9.3	9.3	9.3	9.3	9.8
Output	1.1	1.1	1.6	2.4	2.7	3.0
12-TFC-12/17A	13.2	13.0	13.0	13.0	13.0	13.5
Tap Loss	0.9	1.0	1.3	2.0	2.3	2.8
Output	17.2	17.0	17.0	17.0	17.0	17.5
12-TFC-16/17A	4.1	4.1	4.6	5.3	5.8	6.9
Tap Loss	7.5	7.5	7.9	8.9	9.2	10.0
High	4.4	4.4	4.6	5.0	5.2	6.3
Low						
12-TFC-777/17-A						

## Isolation (dB minimum)

	5–10 MHz	11–600 MHz	601–750 MHz	751–850 MHz	851–1000 MHz	1001–12 MHz
2-LPI/22A and 1-LPI/22A-ACM-3	60	70	65	60	60	57
12-TFC-4/17A	20	28	28	28	28	20
12-TFC-8/17A	25	25	25	25	25	25
2-TFC-12/17A	25	25	25	25	25	25
2-TFC-16/17A	25	25	25	25	25	25
2-TFC-488/17A	20	28	28	28	28	20
2-TFC-777/17A	20	28	28	28	28	20

## 6.4.14 FFE-\*-100\*/RP-R Feederline Equalizers

Model	FFE-8-100S/ RP-R	FFE-8-100A/ RP-R	FFE-8-100K/ RP-R	FFE-8-100N/ RP-R	FFE-12-100S/ RP-R	FFE-12-100A/ RP-R	FFE-12-100K/ RP-R	FFE-12-100N/ RP-R
<b>Passband</b>								
Return (MHz)	5-40	5-65	5-42	5-85	5-40	5-65	5-42	5-85
Forward (MHz)	52-1003	85-1003	54-1003	104-1003	52-1003	85-1003	54-1003	104-1003
<b>Max Insertion Loss (dB)</b>								
5 MHz	0.8	0.8	0.8	0.8	0.8	0.8	0.8	0.8
40/42 MHz	1.2	1.2	1.2	1.2	1.2	1.2	1.2	1.2
52/54 MHz	8.5	8.5	8.5	8.5	12.5	12.5	12.5	12.5
550 MHz	4.0	4.0	4.0	4.0	4.5	4.5	4.5	4.5
750 MHz	2.7	2.7	2.7	2.7	2.7	2.7	2.7	2.7
870 MHz	2.4	2.4	2.4	2.4	2.3	2.3	2.3	2.3
1003 MHz	2.0	2.0	2.0	2.0	2.0	2.0	2.0	2.0
Return Flatness	±0.25	±0.25	±0.25	±0.25	±0.25	±0.25	±0.25	±0.25
Forward Flatness	±0.5	±0.5	±0.5	±0.5	±0.75	±0.75	±0.75	±0.75
Return Loss (max) <sup>1</sup> (dB)	17	17	17	17	17	17	17	17
Return Loss (max) <sup>2</sup> (dB)	17	17	17	17	17	17	17	17
Return Loss (max) <sup>3</sup> (dB)	16	16	16	16	16	16	16	16
Max Current (continuous)	12 A	12 A	12 A	12 A	12 A	12 A	12 A	12 A
<b>Hum Modulation @Max Current</b>								
Forward (fmin-870 MHz)	-70	-70	-70	-70	-70	-70	-70	-70
Forward (870 MHz-1 GHz)	-60	-60	-60	-60	-60	-60	-60	-60
Return	-60	-60	-60	-60	-60	-60	-60	-60

<sup>1</sup>5 MHz-??; <sup>2</sup>?-870 MHz; <sup>3</sup>870-1 GHz

### 6.4.15 Power Bypass Taps (9000-L-PBT Series)

All specifications in this section reflect worst case performance for design purposes and are subject to change without notice.

<b>Philips 9800-L-PBT Series 8-Way Multi-Tap Insertion Loss (dB)</b>						
<b>Model</b>		<b>9812</b>	<b>9815</b>	<b>9818</b>	<b>9821</b>	<b>9824</b>
<b>Tap Value</b>		<b>12.0</b>	<b>15.5</b>	<b>18.0</b>	<b>21.0</b>	<b>24.0</b>
<b>Color Code</b>		<b>Gold</b>	<b>White</b>	<b>Blue</b>	<b>Green</b>	<b>Purple</b>
Insertion Loss (input/output port)	5 MHz	–	3.8	2.2	1.4	1.0
	10 MHz	–	3.8	2.1	1.2	0.8
	30 MHz	–	3.5	2.5	1.0	0.7
	50 MHz	–	3.5	1.9	1.0	0.7
	100 MHz	–	4.0	1.8	1.2	0.7
	330 MHz	–	4.2	2.1	1.3	0.9
	450 MHz	–	4.4	2.3	1.3	0.9
	550 MHz	–	4.5	2.4	1.4	1.1
	600 MHz	–	4.7	2.6	1.4	1.1
	750 MHz	–	5.1	2.8	1.6	1.3
	862 MHz	–	5.3	3.2	1.8	1.4
1000 MHz	–	5.4	3.5	3.5	2.2	1.8
In/Out Return Loss	5 to 10 MHz	15	13	15	15	15
	10 to 30 MHz	17	18	17	17	17
	30 to 600 MHz	18	18	18	18	18
	600 to 900 MHz	17	17	17	17	17
	900 to 1000 MHz	15	15	15	15	15
Tap Return Loss	5 to 10 MHz	15	15	15	15	15
	10 to 30 MHz	15	15	15	15	15
	30 to 600 MHz	18	18	18	18	18
	600 to 900 MHz	16	16	16	16	16
	900 to 1000 MHz	15	15	15	15	15

See page 6-51 for Models 9827 and 9830.

**Philips 9800-L-PBT Series 8-Way Multi-Tap Insertion Loss (dB)**

	<b>Model</b>	<b>9827</b>	<b>9830</b>
	<b>Tap Value</b>	<b>27.0</b>	<b>30.0</b>
	<b>Color Code</b>	<b>Yellow</b>	<b>Red</b>
<b>Insertion Loss (input/output port)</b>	5 MHz	0.9	0.8
	10 MHz	0.8	0.7
	30 MHz	0.7	0.7
	50 MHz	0.7	0.7
	100 MHz	0.7	0.7
	330 MHz	0.8	0.8
	450 MHz	0.9	0.9
	550 MHz	1.0	0.9
	600 MHz	1.1	0.9
	750 MHz	1.2	1.2
	862 MHz	1.4	1.4
	1000 MHz	1.6	1.4
<b>In/Out Return Loss</b>	5 to 10 MHz	15	15
	10 to 30 MHz	17	17
	30 to 600 MHz	18	18
	600 to 900 MHz	17	17
	900 to 1000 MHz	15	15
<b>Tap Return Loss</b>	5 to 10 MHz	15	15
	10 to 30 MHz	15	15
	30 to 600 MHz	18	18
	600 to 900 MHz	16	16
	900 to 1000 MHz	15	15

See page 6-50 for Models 9812, 9815, 9818, 9821, and 9824.

**Philips 9400-L-PBT Series 4-Way Multi-Tap Insertion Loss (dB)**

		<b>Model</b>	<b>9408</b>	<b>9411</b>	<b>9414</b>	<b>9417</b>	<b>9420</b>
		<b>Tap Value</b>	<b>8.0</b>	<b>11.5</b>	<b>14.0</b>	<b>17.0</b>	<b>20.0</b>
		<b>Color Code</b>	<b>Orange</b>	<b>Gold</b>	<b>White</b>	<b>Blue</b>	<b>Green</b>
<b>Insertion Loss (input/output port)</b>	5 MHz	-	3.8	2.1	1.5	1.1	
	10 MHz	-	3.6	2.0	1.4	1.0	
	30 MHz	-	3.5	1.8	1.1	0.7	
	50 MHz	-	3.5	1.8	1.1	0.7	
	100 MHz	-	4.0	1.8	1.1	0.8	
	330 MHz	-	4.3	2.3	1.4	1.0	
	450 MHz	-	4.3	2.3	1.4	1.0	
	550 MHz	-	4.4	2.4	1.5	1.1	
	600 MHz	-	4.7	2.5	1.5	1.1	
	750 MHz	-	5.1	2.7	1.6	1.2	
	862 MHz	-	5.2	3.0	1.8	1.4	
1000 MHz	-	5.4	3.3	2.1	1.6		
<b>In/Out Return Loss</b>	5 to 10 MHz	15	13	15	15	15	
	10 to 30 MHz	17	16	17	17	17	
	30 to 600 MHz	18	18	18	18	18	
	600 to 900 MHz	17	17	17	17	17	
	900 to 1000 MHz	15	15	15	15	15	
<b>Tap Return Loss</b>	5 to 10 MHz	15	15	15	15	15	
	10 to 30 MHz	16	16	16	16	16	
	30 to 600 MHz	18	18	18	18	18	
	600 to 900 MHz	16	16	16	16	16	
	900 to 1000 MHz	15	15	15	15	15	

See page 6-53 for Models 9423, 9426, 9429, 9432, and 9435.

<b>Philips 9400-L-PBT Series 4-Way Multi-Tap Insertion Loss (dB)</b>						
<b>Model</b>		<b>9423</b>	<b>9426</b>	<b>9429</b>	<b>9432</b>	<b>9435</b>
<b>Tap Value</b>		<b>23.0</b>	<b>26.0</b>	<b>29.0</b>	<b>32.0</b>	<b>35.0</b>
<b>Color Code</b>		<b>Purple</b>	<b>Yellow</b>	<b>Red</b>	<b>Silver</b>	<b>Brown</b>
<b>Insertion Loss (input/output port)</b>	5 MHz	1.1	0.8	0.8	0.8	0.8
	10 MHz	1.0	0.7	0.7	0.7	0.7
	30 MHz	0.7	0.5	0.5	0.5	0.5
	50 MHz	0.7	0.5	0.5	0.5	0.5
	100 MHz	0.7	0.5	0.5	0.5	0.5
	330 MHz	0.9	0.8	0.8	0.8	0.8
	450 MHz	0.9	0.8	0.8	0.8	0.8
	550 MHz	1.0	0.9	0.9	0.9	0.9
	600 MHz	1.0	0.9	0.9	0.9	0.9
	750 MHz	1.2	1.0	1.0	1.0	1.0
	862 MHz	1.4	1.1	1.1	1.1	1.1
1000 MHz	1.6	1.4	1.4	1.4	1.4	
<b>In/Out Return Loss</b>	5 to 10 MHz	15	15	15	15	15
	10 to 30 MHz	17	17	17	17	17
	30 to 600 MHz	18	18	18	18	18
	600 to 900 MHz	17	17	17	17	17
	900 to 1000 MHz	15	15	15	15	15
<b>Tap Return Loss</b>	5 to 10 MHz	15	15	15	15	15
	10 to 30 MHz	16	16	16	16	16
	30 to 600 MHz	18	18	18	18	18
	600 to 900 MHz	16	16	16	16	16
	900 to 1000 MHz	15	15	15	15	15

See page 6-52 for Models 9408, 9411, 9414, 9417, and 9420.

**Philips 9200-L-PBT Series 2-Way Multi-Tap Insertion Loss (dB)**

		<b>Model</b>	<b>9204</b>	<b>9208</b>	<b>9211</b>	<b>9214</b>	<b>9217</b>
		<b>Tap Value</b>	<b>4.0</b>	<b>8.0</b>	<b>11.0</b>	<b>14.0</b>	<b>17.0</b>
		<b>Color Code</b>	<b>Black</b>	<b>Orange</b>	<b>Gold</b>	<b>White</b>	<b>Blue</b>
<b>Insertion Loss (input/output port)</b>	5 MHz	–	3.5	2.1	1.2	1.0	
	10 MHz	–	3.4	2.0	1.0	0.9	
	30 MHz	–	3.3	1.9	0.9	0.7	
	50 MHz	–	3.3	1.8	0.9	0.7	
	100 MHz	–	3.3	1.8	0.9	0.8	
	330 MHz	–	3.8	2.0	1.1	1.0	
	450 MHz	–	4.0	2.2	1.1	1.1	
	550 MHz	–	4.2	2.3	1.2	1.1	
	600 MHz	–	4.3	2.4	1.3	1.2	
	750 MHz	–	4.7	2.6	1.4	1.3	
	862 MHz	–	5.1	2.8	1.6	1.5	
1000 MHz	–	5.4	3.2	1.9	1.6		
<b>In/Out Return Loss</b>	5 to 10 MHz	15	14	15	15	15	
	10 to 30 MHz	17	17	17	17	17	
	30 to 600 MHz	18	18	18	18	18	
	600 to 900 MHz	17	17	17	17	17	
	900 to 1000 MHz	15	15	15	15	15	
<b>Tap Return Loss</b>	5 to 10 MHz	15	13	15	15	15	
	10 to 30 MHz	16	16	16	16	16	
	30 to 600 MHz	18	18	18	18	18	
	600 to 900 MHz	16	16	16	16	16	
	900 to 1000 MHz	15	15	15	15	15	

See page 6-55 for Models 9220, 9223, 9226, 9229, and 9232.



**Philips 9200-L-PBT Series 2-Way Multi-Tap Insertion Loss (dB)**

	Model	9220	9223	9226	9229	9232
	Tap Value	20.0	23.0	26.0	29.0	32.0
	Color Code	Green	Purple	Yellow	Red	Silver
Insertion Loss (input/output port)	5 MHz	1.1	0.8	0.8	0.8	0.8
	10 MHz	1.0	0.6	0.6	0.6	0.6
	30 MHz	0.7	0.6	0.6	0.6	0.6
	50 MHz	0.7	0.6	0.6	0.6	0.6
	100 MHz	0.8	0.6	0.6	0.6	0.6
	330 MHz	0.9	0.7	0.7	0.7	0.7
	450 MHz	0.9	0.8	0.8	0.8	0.8
	550 MHz	1.0	0.9	0.9	0.9	0.9
	600 MHz	1.0	0.9	0.9	0.9	0.9
	750 MHz	1.2	1.0	1.0	1.0	1.0
	862 MHz	1.4	1.2	1.2	1.2	1.2
1000 MHz	1.6	1.4	1.4	1.4	1.4	
In/Out Return Loss	5 to 10 MHz	15	15	15	15	15
	10 to 30 MHz	17	17	17	17	17
	30 to 600 MHz	18	18	18	18	18
	600 to 900 MHz	17	17	17	17	17
	900 to 1000 MHz	15	15	15	15	15
Tap Return Loss	5 to 10 MHz	15	15	15	15	15
	10 to 30 MHz	16	16	16	16	16
	30 to 600 MHz	18	18	18	18	18
	600 to 900 MHz	16	16	16	16	16
	900 to 1000 MHz	15	15	15	15	15

See page 6-54 for Models 9204, 9208, 9211, 9214, and 9217.

### 6.4.16 Telephony Twisted-Pair Taps (9000T-TP Series)

All specifications in this section reflect nominal performance for design purposes and are subject to change without notice.

Philips 9800T-TP Series 8-Way Multi-Tap Insertion Loss (dB)						
Model		9812	9815	9818	9821	9824
Tap Value		12.0	15.0	18.0	21.0	24.0
Color Code		Gold	White	Blue	Green	Purple
Insertion Loss (input/output port)	10 MHz	–	2.6	1.4	0.8	0.5
	30 MHz	–	2.5	1.3	0.7	0.4
	54 MHz	–	2.4	1.2	0.6	0.4
	70 MHz	–	2.6	1.4	0.8	0.6
	112 MHz	–	2.9	1.7	1.0	0.8
	150 MHz	–	2.9	1.7	1.0	0.8
	186 MHz	–	2.9	1.7	1.0	0.8
	222 MHz	–	3.0	1.8	1.1	0.8
	330 MHz	–	3.0	1.9	1.1	0.8
	400 MHz	–	3.1	1.9	1.2	0.8
	450 MHz	–	3.1	1.9	1.2	0.8
	550 MHz	–	3.3	2.1	1.3	0.9
	600 MHz	–	3.5	2.1	1.3	0.9
	750 MHz	–	3.9	2.4	1.5	1.1
862 MHz	–	4.1	2.7	1.7	1.3	
1000 MHz	–	4.3	3.0	2.2	1.7	
Tap Loss (input/tap port)	10 to 19 MHz	11.0	15.3	17.9	21.4	24.1
	20 to 899 MHz	11.3	15.1	17.6	21.1	23.7
	900 to 1000 MHz	12.5	16.2	18.7	21.9	24.2

See page 6-57 for Models 9827, 9830, 9833, and 9836.

<b>Philips 9800T-TP Series 8-Way Multi-Tap Insertion Loss (dB)</b>					
<b>Model</b>		<b>9827</b>	<b>9830</b>	<b>9833</b>	<b>9836</b>
<b>Tap Value</b>		<b>27.0</b>	<b>30.0</b>	<b>33.0</b>	<b>36.0</b>
<b>Color Code</b>		<b>Yellow</b>	<b>Red</b>	<b>Silver</b>	<b>Brown</b>
<b>Insertion Loss (input/output port)</b>	10 MHz	0.5	0.4	0.3	0.4
	30 MHz	0.4	0.3	0.3	0.3
	54 MHz	0.3	0.3	0.3	0.3
	70 MHz	0.4	0.3	0.3	0.3
	112 MHz	0.5	0.4	0.4	0.4
	150 MHz	0.5	0.4	0.4	0.4
	186 MHz	0.5	0.4	0.4	0.4
	222 MHz	0.5	0.4	0.4	0.4
	330 MHz	0.5	0.4	0.4	0.4
	400 MHz	0.6	0.5	0.5	0.5
	450 MHz	0.6	0.5	0.5	0.5
	550 MHz	0.6	0.5	0.5	0.5
	600 MHz	0.7	0.7	0.7	0.7
	750 MHz	0.8	0.7	0.8	0.7
862 MHz	0.9	0.8	0.8	0.8	
1000 MHz	1.1	1.0	1.0	1.0	
<b>Tap Loss (input/tap port)</b>	10 to 19 MHz	25.9	28.8	31.7	34.7
	20 to 899 MHz	26.9	30.1	32.5	35.6
	900 to 1000 MHz	27.4	30.3	33.0	36.3

See page 6-56 for Models 9812, 9815, 9818, 9821, and 9824.

**Philips 9400T-TP Series 4-Way Multi-Tap Insertion Loss (dB)**

<b>Model</b>		<b>9408</b>	<b>9411</b>	<b>9414</b>	<b>9417</b>	<b>9420</b>
<b>Tap Value</b>		<b>8.0</b>	<b>11.5</b>	<b>14.5</b>	<b>17.0</b>	<b>20.0</b>
<b>Color Code</b>		<b>Orange</b>	<b>Gold</b>	<b>White</b>	<b>Blue</b>	<b>Green</b>
<b>Insertion Loss (input/output port)</b>	10 MHz	-	3.2	1.4	0.7	0.5
	30 MHz	-	3.2	1.3	0.6	0.4
	54 MHz	-	3.2	1.2	0.6	0.4
	70 MHz	-	3.5	1.4	0.8	0.6
	112 MHz	-	3.7	1.6	0.9	0.8
	186 MHz	-	3.8	1.6	0.9	0.8
	222 MHz	-	3.8	1.6	0.9	0.8
	330 MHz	-	3.9	1.7	1.0	0.8
	400 MHz	-	4.0	1.8	1.0	0.8
	450 MHz	-	4.0	1.8	1.0	0.8
	550 MHz	-	4.1	1.9	1.1	0.9
	600 MHz	-	4.4	2.0	1.2	0.9
	750 MHz	-	4.6	2.4	1.4	1.1
862 MHz	-	4.5	2.8	1.5	1.3	
1000 MHz	-	4.4	3.4	2.0	1.7	
<b>Tap Loss (input/tap port)</b>	10 to 19 MHz	6.8	10.7	14.9	17.5	20.2
	20 to 899 MHz	7.2	10.5	14.9	17.2	19.8
	900 to 1000 MHz	8.6	13.3	15.7	17.7	20.7

See page 6-59 for Models 9423, 9426, 9429, 9432, and 9435.

<b>Philips 9400T-TP Series 4-Way Multi-Tap Insertion Loss (dB)</b>						
<b>Model</b>		<b>9423</b>	<b>9426</b>	<b>9429</b>	<b>9432</b>	<b>9435</b>
<b>Tap Value</b>		<b>23.0</b>	<b>26.0</b>	<b>29.0</b>	<b>32.0</b>	<b>35.0</b>
<b>Color Code</b>		<b>Purple</b>	<b>Yellow</b>	<b>Red</b>	<b>Silver</b>	<b>Brown</b>
<b>Insertion Loss (input/output port)</b>	10 MHz	0.4	0.4	0.3	0.3	0.3
	30 MHz	0.4	0.3	0.3	0.3	0.3
	54 MHz	0.4	0.3	0.3	0.3	0.3
	70 MHz	0.6	0.3	0.3	0.3	0.3
	112 MHz	0.7	0.4	0.4	0.4	0.4
	186 MHz	0.7	0.4	0.4	0.4	0.4
	222 MHz	0.7	0.4	0.4	0.4	0.4
	330 MHz	0.7	0.5	0.5	0.5	0.5
	400 MHz	0.7	0.5	0.5	0.5	0.5
	450 MHz	0.7	0.5	0.5	0.5	0.5
	550 MHz	0.8	0.6	0.5	0.5	0.5
	600 MHz	0.8	0.6	0.6	0.6	0.6
	750 MHz	1.0	0.8	0.8	0.7	0.8
	862 MHz	1.1	0.9	0.9	0.8	0.9
1000 MHz	1.6	1.1	1.0	0.9	1.1	
<b>Tap Loss (input/tap port)</b>	10 to 19 MHz	23.3	25.4	28.3	31.4	34.4
	20 to 899 MHz	22.8	26.1	29.1	32.0	35.0
	900 to 1000 MHz	23.8	25.9	29.5	32.2	34.9

See page 6-58 for Models 9408, 9411, 9414, 9417, and 9420.

**Philips 9200T-TP Series 2-Way Multi-Tap Insertion Loss (dB)**

		<b>Model</b>	<b>9204</b>	<b>9208</b>	<b>9211</b>	<b>9214</b>	<b>9217</b>
		<b>Tap Value</b>	<b>4.0</b>	<b>8.5</b>	<b>11.0</b>	<b>14.0</b>	<b>17.0</b>
		<b>Color Code</b>	<b>Black</b>	<b>Orange</b>	<b>Gold</b>	<b>White</b>	<b>Blue</b>
<b>Insertion Loss (input/output port)</b>		10 MHz	–	2.7	1.3	0.6	0.5
		30 MHz	–	2.7	1.2	0.6	0.4
		54 MHz	–	2.6	1.2	0.6	0.4
		70 MHz	–	2.9	1.4	0.7	0.6
		112 MHz	–	3.1	1.6	0.9	0.8
		150 MHz	–	3.3	1.6	0.9	0.8
		186 MHz	–	3.3	1.6	0.9	0.8
		222 MHz	–	3.3	1.6	0.9	0.8
		330 MHz	–	3.3	1.6	1.0	0.8
		400 MHz	–	3.4	1.7	1.0	0.8
		450 MHz	–	3.4	1.7	1.0	0.8
		550 MHz	–	3.5	1.8	1.0	0.8
		600 MHz	–	3.6	1.9	1.1	0.9
		750 MHz	–	3.9	2.2	1.3	1.1
		862 MHz	–	4.1	2.4	1.4	1.3
	1000 MHz	–	4.0	2.9	1.8	1.7	
<b>Tap Loss (input/tap port)</b>		10 to 19 MHz	3.4	7.6	11.3	14.8	17.1
		20 to 899 MHz	3.6	7.5	11.2	14.7	16.6
		900 to 1000 MHz	4.5	9.2	12.1	15.0	17.0

See page 6-61 for Models 9220, 9223, 9226, 9229, and 9232.

<b>Philips 9200T-TP Series 2-Way Multi-Tap Insertion Loss (dB)</b>						
<b>Model</b>		<b>9220</b>	<b>9223</b>	<b>9226</b>	<b>9229</b>	<b>9232</b>
<b>Tap Value</b>		<b>20.0</b>	<b>23.0</b>	<b>26.0</b>	<b>29.0</b>	<b>32.0</b>
<b>Color Code</b>		<b>Green</b>	<b>Purple</b>	<b>Yellow</b>	<b>Red</b>	<b>Silver</b>
<b>Insertion Loss (input/output port)</b>	10 MHz	0.4	0.3	0.3	0.3	0.3
	30 MHz	0.4	0.3	0.3	0.3	0.3
	54 MHz	0.3	0.3	0.3	0.3	0.3
	70 MHz	0.4	0.3	0.3	0.3	0.3
	112 MHz	0.7	0.5	0.4	0.4	0.4
	150 MHz	0.5	0.4	0.4	0.4	0.4
	186 MHz	0.5	0.4	0.4	0.4	0.4
	222 MHz	0.5	0.4	0.4	0.4	0.4
	330 MHz	0.5	0.5	0.4	0.4	0.5
	400 MHz	0.6	0.5	0.5	0.5	0.5
	450 MHz	0.6	0.5	0.5	0.5	0.5
	550 MHz	0.6	0.5	0.5	0.5	0.5
	600 MHz	0.7	0.6	0.6	0.6	0.6
	750 MHz	0.9	0.8	0.7	0.8	0.8
	862 MHz	1.0	0.8	0.8	0.8	0.9
1000 MHz	1.1	1.0	0.9	0.9	1.0	
<b>Tap Loss (input/tap port)</b>	10 to 19 MHz	19.6	22.3	25.2	28.3	31.3
	20 to 899 MHz	20.3	23.0	25.9	28.8	31.7
	900 to 1000 MHz	21.0	23.7	27.2	29.7	32.9

See page 6-60 for Models 9204, 9208, 9211, 9214, and 9217.

### 6.4.17 Telephony F-Port Taps (9000T-FP Series)

All specifications in this section reflect nominal performance for design purposes and are subject to change without notice.

Philips 9800T-FP Series 8-Way Multi-Tap Insertion Loss (dB)						
Model		9812	9815	9818	9821	9824
Tap Value		12.0	15.5	18.0	21.0	24.0
Color Code		Gold	White	Blue	Green	Purple
Insertion Loss (input/output port)	10 MHz	–	3.5	1.4	1.1	0.9
	30 MHz	–	3.4	1.3	0.9	0.7
	54 MHz	–	3.4	1.3	0.9	0.7
	112 MHz	–	3.8	1.7	1.0	0.8
	150 MHz	–	3.8	1.7	1.0	0.8
	186 MHz	–	3.9	1.8	1.0	0.8
	222 MHz	–	3.9	1.8	1.1	0.8
	330 MHz	–	4.0	1.9	1.1	0.8
	400 MHz	–	4.1	2.0	1.1	0.8
	450 MHz	–	4.1	2.0	1.1	0.9
	550 MHz	–	4.2	2.0	1.1	0.9
	600 MHz	–	4.5	2.2	1.2	0.9
	750 MHz	–	4.9	2.6	1.3	1.0
	862 MHz	–	5.0	2.9	1.5	1.2
1000 MHz	–	5.2	3.5	3.5	1.7	1.2
Tap Loss (input/tap port)	10 to 19 MHz	10.7	13.8	17.8	19.4	22.3
	20 to 899 MHz	11.3	14.6	18.4	20.6	24.3
	900 to 1000 MHz	13.0	16.7	18.8	20.7	25.1

See page 6-61 for Models 9827, 9830, 9833, and 9836.



<b>Philips 9800T-FP Series 8-Way Multi-Tap Insertion Loss (dB)</b>					
<b>Model</b>		<b>9827</b>	<b>9830</b>	<b>9833</b>	<b>9836</b>
<b>Tap Value</b>		<b>27.0</b>	<b>30.0</b>	<b>33.0</b>	<b>36.0</b>
<b>Color Code</b>		<b>Yellow</b>	<b>Red</b>	<b>Silver</b>	<b>Brown</b>
<b>Insertion Loss (input/output port)</b>	10 MHz	0.7	0.3	0.3	0.3
	30 MHz	0.6	0.3	0.3	0.3
	54 MHz	0.5	0.3	0.3	0.3
	112 MHz	0.7	0.4	0.5	0.4
	150 MHz	0.7	0.4	0.5	0.4
	186 MHz	0.7	0.4	0.5	0.4
	222 MHz	0.7	0.4	0.5	0.4
	330 MHz	0.7	0.5	0.5	0.5
	400 MHz	0.7	0.5	0.5	0.5
	450 MHz	0.7	0.6	0.6	0.5
	550 MHz	0.7	0.6	0.6	0.5
	600 MHz	0.8	0.7	0.7	0.6
	750 MHz	0.9	0.8	0.8	0.8
	862 MHz	1.1	1.0	1.0	1.0
1000 MHz	1.1	1.1	1.1	1.1	
<b>Tap Loss (input/tap port)</b>	10 to 19 MHz	25.5	28.8	32.2	34.5
	20 to 899 MHz	26.7	30.4	32.8	35.6
	900 to 1000 MHz	27.8	30.4	33.2	36.3

See page 6-62 for Models 9812, 9815, 9818, 9821, and 9824.

**Philips 9400T-FP Series 4-Way Multi-Tap Insertion Loss (dB)**

<b>Model</b>		<b>9408</b>	<b>9411</b>	<b>9414</b>	<b>9417</b>	<b>9420</b>
<b>Tap Value</b>		<b>8.0</b>	<b>11.5</b>	<b>14.5</b>	<b>17.0</b>	<b>20.0</b>
<b>Color Code</b>		<b>Orange</b>	<b>Gold</b>	<b>White</b>	<b>Blue</b>	<b>Green</b>
<b>Insertion Loss (input/output port)</b>	10 MHz	-	3.5	1.3	1.0	0.9
	30 MHz	-	3.4	1.3	0.7	0.7
	54 MHz	-	3.4	1.3	0.7	0.7
	112 MHz	-	3.8	1.7	0.9	0.8
	150 MHz	-	3.8	1.7	0.9	0.8
	186 MHz	-	3.9	1.8	0.9	0.9
	222 MHz	-	3.9	1.8	0.9	0.9
	330 MHz	-	4.0	1.8	0.9	0.9
	400 MHz	-	4.1	1.8	1.0	0.9
	450 MHz	-	4.1	1.8	1.0	0.9
	550 MHz	-	4.2	1.9	1.0	0.9
	600 MHz	-	4.4	2.1	1.1	0.9
	750 MHz	-	4.7	2.6	1.3	1.1
862 MHz	-	4.8	3.0	1.6	1.3	
1000 MHz	-	4.9	3.6	1.8	1.3	
<b>Tap Loss (input/tap port)</b>	10 to 19 MHz	6.9	10.3	14.5	15.8	19.4
	20 to 899 MHz	7.2	10.7	14.7	17.6	21.0
	900 to 1000 MHz	8.2	12.8	15.0	18.2	20.7

See page 6-65 for Models 9423, 9426, 9429, 9432, and 9435.

<b>Philips 9400T-FP Series 4-Way Multi-Tap Insertion Loss (dB)</b>						
<b>Model</b>		<b>9423</b>	<b>9426</b>	<b>9429</b>	<b>9432</b>	<b>9435</b>
<b>Tap Value</b>		<b>23.0</b>	<b>26.0</b>	<b>29.0</b>	<b>32.0</b>	<b>35.0</b>
<b>Color Code</b>		<b>Purple</b>	<b>Yellow</b>	<b>Red</b>	<b>Silver</b>	<b>Brown</b>
<b>Insertion Loss (input/output port)</b>	10 MHz	0.6	0.3	0.3	0.3	0.3
	30 MHz	0.6	0.3	0.3	0.3	0.3
	54 MHz	0.6	0.3	0.3	0.3	0.3
	112 MHz	0.7	0.5	0.5	0.5	0.5
	150 MHz	0.7	0.5	0.5	0.5	0.5
	186 MHz	0.7	0.5	0.5	0.5	0.5
	222 MHz	0.7	0.5	0.5	0.5	0.5
	330 MHz	0.7	0.5	0.5	0.5	0.5
	400 MHz	0.8	0.5	0.6	0.6	0.5
	450 MHz	0.8	0.5	0.6	0.6	0.5
	550 MHz	0.8	0.6	0.6	0.6	0.6
	600 MHz	0.8	0.6	0.6	0.7	0.6
	750 MHz	1.0	0.9	0.8	0.8	0.8
	862 MHz	1.1	1.1	1.0	1.0	1.0
1000 MHz	1.1	1.1	1.0	1.0	1.0	
<b>Tap Loss (input/tap port)</b>	10 to 19 MHz	22.1	24.9	27.9	31.0	34.2
	20 to 899 MHz	23.6	26.3	29.2	32.2	35.3
	900 to 1000 MHz	23.2	26.0	29.1	32.0	35.2

See page 6-64 for Models 9408, 9411, 9414, 9417, and 9420.

**Philips 9200T-FP Series 2-Way Multi-Tap Insertion Loss (dB)**

<b>Model</b>		<b>9204</b>	<b>9208</b>	<b>9211</b>	<b>9214</b>	<b>9217</b>
<b>Tap Value</b>		<b>4.0</b>	<b>8.5</b>	<b>11.0</b>	<b>14.0</b>	<b>17.0</b>
<b>Color Code</b>		<b>Black</b>	<b>Orange</b>	<b>Gold</b>	<b>White</b>	<b>Blue</b>
<b>Insertion Loss (input/output port)</b>	10 MHz	–	2.8	1.3	1.0	0.9
	30 MHz	–	2.8	1.3	0.8	0.7
	54 MHz	–	2.8	1.3	0.7	0.7
	112 MHz	–	3.2	1.7	0.9	0.8
	150 MHz	–	3.2	1.7	0.9	0.8
	186 MHz	–	3.2	1.7	0.9	0.8
	222 MHz	–	3.3	1.7	0.9	0.9
	330 MHz	–	3.4	1.8	0.9	0.9
	400 MHz	–	3.4	1.9	1.0	0.9
	450 MHz	–	3.4	1.9	1.0	0.9
	550 MHz	–	3.5	1.9	1.0	0.9
	600 MHz	–	3.8	2.1	1.1	1.0
	750 MHz	–	4.3	2.5	1.2	1.2
862 MHz	–	4.5	2.8	1.4	1.3	
1000 MHz	–	4.8	3.5	3.5	1.6	1.3
<b>Tap Loss (input/tap port)</b>	10 to 19 MHz	3.4	7.7	10.8	13.7	15.7
	20 to 899 MHz	3.7	8.0	11.1	14.9	17.4
	900 to 1000 MHz	5.2	9.6	11.0	15.2	17.0

See page 6-67 for Models 9220, 9223, 9226, 9229, and 9232.

<b>Philips 9200T-FP Series 2-Way Multi-Tap Insertion Loss (dB)</b>						
<b>Model</b>		<b>9220</b>	<b>9223</b>	<b>9226</b>	<b>9229</b>	<b>9232</b>
<b>Tap Value</b>		<b>20.0</b>	<b>23.0</b>	<b>26.0</b>	<b>29.0</b>	<b>32.0</b>
<b>Color Code</b>		<b>Green</b>	<b>Purple</b>	<b>Yellow</b>	<b>Red</b>	<b>Silver</b>
<b>Insertion Loss (input/output port)</b>	10 MHz	0.7	0.3	0.3	0.3	0.3
	30 MHz	0.6	0.3	0.3	0.3	0.3
	54 MHz	0.6	0.3	0.3	0.3	0.3
	112 MHz	0.7	0.5	0.5	0.4	0.4
	150 MHz	0.7	0.5	0.5	0.4	0.4
	186 MHz	0.7	0.5	0.5	0.4	0.4
	222 MHz	0.8	0.5	0.5	0.5	0.5
	330 MHz	0.8	0.5	0.5	0.5	0.5
	400 MHz	0.8	0.6	0.6	0.5	0.5
	450 MHz	0.8	0.6	0.6	0.5	0.5
	550 MHz	0.8	0.6	0.6	0.5	0.6
	600 MHz	0.9	0.6	0.6	0.6	0.6
	750 MHz	1.0	0.8	0.8	0.7	0.8
	862 MHz	1.1	0.9	0.9	0.9	1.0
1000 MHz	1.1	1.0	1.0	1.0	1.1	
<b>Tap Loss (input/tap port)</b>	10 to 19 MHz	18.4	21.2	24.4	27.2	30.5
	20 to 899 MHz	20.0	22.6	25.5	28.1	31.2
	900 to 1000 MHz	20.0	23.2	26.5	29.1	32.8

See page 6-66 for Models 9204, 9208, 9211, 9214, and 9217.

## ARRIS Main Line Passives, LS Series

Model Number	Parameter	Port	Spec	Loss in dB at Frequency (MHz)									
				5	10	50	300	450	550	750	860	1000	
LS-15G-2 (2-Way Splitter)	Insert. Loss	1-3, 1-4	Max.	3.91	3.80	4.16	4.20	4.30	4.50	4.70	4.90		
			Min.	22	22	22	22	22	22	22	22	22	
LS-15G-3 (3-Way Splitter)	Insert. Loss	1-2, 1-4	Max.	7.20	7.15	7.55	7.55	7.60	7.90	8.20	8.65		
			Min.	22	22	22	22	22	22	22	22	22	
LS-15G-DC-8 (Directional Coupler)	Insert. Loss	1-3	Max.	2.10	2.00	2.20	2.20	2.30	2.53	2.60	2.85		
			Min.	22	22	22	22	22	22	22	22	22	
	Tap	1-4	Max.	8.48	8.50	8.60	8.65	8.70	8.75	8.87	9.10		
			Min.	18	22	22	22	22	22	22	22	22	

## ARRIS Main Line Passives, LS Series

Model Number	Parameter	Port	Spec	Loss in dB at Frequency (MHz)									
				5	10	50	300	450	550	750	860	1000	
LS-15G-DC-12 (Directional Coupler)	Insert. Loss	1-3	Max.	1.25	1.15	1.15	1.35	1.39	1.50	1.74	1.86	2.00	
	Tap	1-4	Max.	12.20	12.20	12.30	12.40	12.40	12.40	12.50	12.50	12.55	
	Isolation	3-4	Min.	26	26	26	22	22	22	22	22	22	
LS-15G-DC-16 (Directional Coupler)	Insert. Loss	1-3	Max.	1.17	1.02	1.02	1.12	1.21	1.25	1.35	1.38	1.68	
	Tap	1-4	Max.	15.90	16.00	16.10	16.30	16.10	16.10	16.20	16.20	16.60	
	Isolation	3-4	Min.	23	25	25	25	25	25	22	22	22	
LSB-15G-MC (Splice Box)	Insert. Loss	1-3	Max.	0.10	0.10	0.10	0.10	0.15	0.17	0.22	0.22	0.25	
LS-15G-C (Power Inserters)	Insert. Loss	1-3	Max.	0.60	0.40	0.45	0.60	0.80	0.90	1.00	1.05	1.15	
	Isolation	3-4	Min.	70	70	70	65	60	60	60	60	60	
Return Loss All Ports:				Min.	18	18	20	20	20	20	20	20	20

## ARRIS Feeder Line Equalizer, LS Series

Model Number/(P/N)	Parameter	Loss in dB at Frequency (MHz)											
		5-42	54	100	200	300	400	500	550	600	700	750	862
LS-FEQR-750 (PS0126) [750MHz]	Insertion Loss, dB	1.2	9.0	7.8	6.4	5.2	4.1	3.2	3.0	2.6	1.6	1.5	—
	Cable Equalizer, dB	—	—	—	—	5.6	—	—	7.9	—	—	9.0	—
	Passband, Fwd/Rtn, MHz	54-750/5-42											
	Passband Flatness, dB	±0.25											
LS-FEQR-862 (PS0125) [862MHz]	Insertion Loss, dB	1.2	10.0	8.5	7.2	6.1	5.2	4.3	3.9	3.4	2.7	2.3	1.8
	Cable Equalizer, dB	—	—	—	—	—	—	—	8.0	—	—	—	10.3
	Passband, Fwd/Rtn, MHz	54-862/5-42											
	Passband Flatness, dB	±0.3											
<b>Common Specifications</b>													
Impedance, Ohms, All Ports		75											
Return Loss, Input and Output, dB Min.		18											
Power Passing, Amps Max.		15											
Return PAD Model and Range		ARRIS Model IPB-x Series, 0 to 22dB range											



# Fiber Data



***CommScope, Inc.***

## 7.1 Fiber Optic Color Code

Individual fibers in a multi-fiber cable can be identified by an EIA/TIA-598 defined color code which is given in the table below.

**EIA/TIA-598 Fiber Color Code**

Number	Color	Number	Color
1	Blue	7	Red
2	Orange	8	Black
3	Green	9	Yellow
4	Brown	10	Violet
5	Slate	11	Rose
6	White	12	Aqua

## 7.2 Fiber Loss

### CommScope Optical Reach® Fiber Cable Single Mode 1310/1550nm (9/125µm)

	Depressed	Matched Clad	Units
Max. Attenuation at 1310nm	0.35	0.35	dB/km
	0.56	0.56	dB/mi
	0.107	0.107	dB/1000 ft
at 1550nm	0.25	0.25	dB/km
	0.40	0.40	dB/mi
	0.076	0.076	dB/1000 ft
Max. Dispersion at 1285– 1330nm	<2.8	<3.2	ps/nm·km
	18	18	ps/nm·km
at 1550nm			
Fusion splices <sup>1</sup>	0.05	0.05	dB/km
Mechanical splice <sup>1</sup>	0.15dB per splice		
Connector loss <sup>1</sup>	0.25dB per each super FC to PC connector set		
Sag and storage <sup>1</sup>	Add 4% to fiber length		

1. Typically accepted values.

## Fiber Optic Cable Loss Characteristics

Path Length		1310nm (dB)			1550nm (dB)		
km	mi	Fiber Loss	with splices	with conn.	Fiber Loss	with splices	with conn.
1	0.6	0.35	0.40	0.90	0.25	0.30	0.80
2	1.2	0.70	0.80	1.30	0.50	0.60	1.10
3	1.9	1.05	1.20	1.70	0.75	0.90	1.40
4	2.5	1.40	1.60	2.10	1.00	1.20	1.70
5	3.1	1.75	2.00	2.50	1.25	1.50	2.00
6	3.7	2.10	2.40	2.90	1.50	1.80	2.30
7	4.3	2.45	2.80	3.30	1.75	2.10	2.60
8	5.0	2.80	3.20	3.70	2.00	2.40	2.90
9	5.6	3.15	3.60	4.10	2.25	2.70	3.20
10	6.2	3.50	4.00	4.50	2.50	3.00	3.50
20	12.4	7.00	8.00	8.50	5.00	6.00	6.50
30	18.6	10.50	12.00	12.50	7.50	9.00	9.50
40	24.9	14.00	16.00	16.50	10.00	12.00	12.50
50	31.1	17.50	20.00	20.50	12.50	15.00	15.50
60	37.3	21.00	24.00	24.50	15.00	18.00	18.50
70	43.4	24.50	28.00	28.50	17.50	21.00	21.50
80	49.7	28.00	32.00	32.50	20.00	24.00	24.50
90	55.9	31.50	36.00	36.50	22.50	27.00	27.50
100	62	35.00	40.00	40.50	25.00	30.00	30.50

### 7.3 Optical Connectors

Optical connector types (illustrated in the *Optical Connectors* figure on page 7-4) all come in APC (angled) and UPC (ultra-polished, flat) ends.

### 7.3.1 Color Coding

Although there is no official industry color code for SC connectors, there is a commonly-used color code to indicate APC/UPC type to ensure that fiber cable connectors are mated with the corresponding bulkhead connectors.

ANSI/TIA/EIA-568-A (TIA/EIA-568-A), "Commercial Building Telecommunications Cabling Standard," specifies that SC/APC connectors are *green* and SC/UPC connectors are *blue*.

E2000 connectors follow the same color coding convention as SC connectors. E2000/APC connectors are *green*.



**Note:** Bulkhead connector adapters should also—but may not—follow this typical color coding.

There is no industry color standard to distinguish FC/APC and FC/UPC connectors. FC connectors have a metal ferrule that is used to screw the connector into a metal FC adapter. The rubber boots at the base of these ferrules come in a variety of colors, but these colors typically vary from one vendor to another.

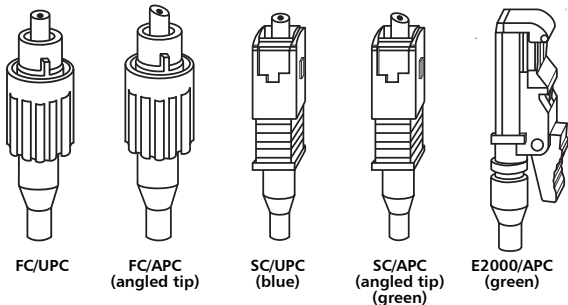

MPO/APC



LC/APC

## Optical Connectors



**CAUTION:** U.S. manufactured APC optical connectors are angled at 8°. Some non-U.S. manufacturers make 9° APC connectors which will not mate with 8° connectors. The eye cannot distinguish between 8° and 9° angles, even when placed side by side. Check connector specifications.

### 7.3.2 Specifications

#### JDS Optical Connector Specifications

	FC/APC or SC/APC	FC/PC or SC/PC
<b>Return Loss</b>	60dB min, 68dB typ	50dB min, 55dB typ
<b>Insertion Loss</b>	0.15dB typical, 0.30dB maximum	
<b>Mating Durability</b>	200 matings, 25 cleanings	

#### Legacy Motorola Connector Specifications—A

Model	Insertion Loss (dB)			
	Through Port		Tap Port	
	Min	Max	Min	Max
AM-OCM-II-50/50-APC	2.72	3.73	2.72	3.73
55/45	2.40	3.20	3.23	4.12
60/40	2.04	2.80	3.72	4.66
65/35	1.71	2.44	4.26	5.28
70/30	1.40	2.11	4.88	6.01
75/25	1.11	1.80	5.61	6.88
80/20	0.84	1.51	6.48	7.97
85/15	0.58	1.24	7.57	9.43
90/10	0.34	0.98	9.03	11.65
95/5	0.15	0.69	11.87	14.96

## Legacy Motorola Connector Specifications—B

Model	Port 1		Port 2		Port 3	
	Min	Max	Min	Max	Min	Max
AM-OCM-II-33/33/33-APC	4.50	5.81	4.50	5.81	4.50	5.81
20/20/40	6.48	8.22	3.72	4.91	3.72	4.91
30/35/35	4.88	6.26	4.26	5.53	4.26	5.53
40/30/30	3.72	4.91	4.88	6.26	4.88	6.26
50/25/25	2.80	3.88	5.61	7.13	5.61	7.13
60/20/20	2.04	3.05	6.48	8.22	6.48	8.22

## Legacy Motorola Connector Specifications—C

Model	All Ports	
	Min	Max
AM-OCM-II-25/25/25/25-APC	5.61	7.13
AM-OCM-II-8x12.5-APC	8.24	10.90

## Legacy Motorola Connector Specifications—General

Spectral Range	1310 and/or 1550 nm
Optical Return Loss	45 dB (min)
Directivity	50 dB (min)
Temperature Range	-40 °C to 85 °C (-40 °F to 185 °F)

### 7.4 Optical Attenuators

Optical attenuators are used to manage optical signals to multiple receivers which require different input levels. They are typically available in 1 dB steps from 1 dB to 30dB, with either SC/APC, SC/UPC, FC/APC, FC/UPC, or E2000/APC connectors. They can be purchased as 1310nm only, 1550nm only, or 1310 and 1550nm.

## 7.5 Optical Couplers and Splitters

An optical coupler is used to split an optical signal to multiple signals or to combine multiple signals into one signal. Optical couplers are typically defined by a percentage ratio at the output ports, instead of a dB loss value. The loss through a coupler port can be approximated by the following equation.

$$\text{Loss through Port A (dB)} = 10\log_{10}(\text{split ratio}) - \text{AL}$$

Where the split ratio is the percentage of signal through Port A. For example, if 75% of the signal passes through Port A the split ratio is 0.75. **AL** is the additional non-ideal coupler loss and is dependant on the manufacturer and the number of ports on the coupler. The following tables are for reference purposes only. Actual losses will vary between vendors.

**ARRIS 1 x n Optical Couplers**

Split (%)	Typical Loss (dB)	Split (%)	Typical Loss (dB)
99	0.15	1	21.3
97	0.25	3	16.1
95	0.36	5	14.0
90	0.6	10	10.5
85	0.8	15	8.6
80	1.1	20	7.3
75	1.4	25	6.3
70	1.7	30	5.5
67	2.3	33	5.3
65	2.1	35	4.8
60	2.4	40	4.2
55	2.8	45	3.8
50	3.3	50	3.3

**Typical Additional Loss (AL) per Number of Ports<sup>1,2</sup>**

Number of Ports	Additional Loss (dB)	Number of Ports	Additional Loss (dB)
1 x 2	0.3	1 x 13	1.2
1 x 3	0.6	1 x 14	1.2

## Typical Additional Loss (AL) per Number of Ports<sup>1,2</sup>

Number of Ports	Additional Loss (dB)	Number of Ports	Additional Loss (dB)
1 x 4	0.6	1 x 15	1.2
1 x 5	0.9	1 x 16	1.2
1 x 6	0.9	1 x 17	1.5
1 x 7	0.9	1 x 18	1.5
1 x 8	0.9	1 x 19	1.5
1 x 9	1.2	1 x 20	1.5
1 x 10	1.2	1 x 21	1.5
1 x 11	1.2	1 x 22	1.5
1 x 12	1.2		

1. Includes 0.3dB for connector loss.
2. Example: A 20% port on a 1 x 2 coupler has a typical loss of 7.6dB (7.3dB insertion loss + 0.3dB connector loss), while a 20% port on a 1 x 4 coupler has a typical loss of 7.9dB (7.3dB insertion loss + 0.6dB AL).

## 7.6 Fiber Care and Cleaning



**DANGER:** Avoid direct exposure to laser radiation. Transmitted light will be invisible to the human eye but may be present. Disconnected optical connectors may emit this invisible optical radiation. Depending on received optical input power or transmitter output power, laser light—visible or invisible—can seriously injure eyes or even cause blindness. Do not stare into beam or view directly with optical instruments or view without using safety glasses.



**CAUTION:** Dust caps do not keep connectors completely free of dust or contaminants. Perform the procedures below each time fiber is handled and connections are made.

The fiber optic medium does not suffer from problems associated with copper-based coaxial cables, such as electromagnetic interference and increasing loss of signal power at higher frequencies due to cable lengths. However, the ability of the



optical fiber, a thin, flexible strand of silica glass, to enable light to travel through it with as little interference as possible depends on the purity of the glass, the manner of its construction, and its care during handling, splicing, and installation. The information in the following sections should be considered prior to installation.

Consult *Recommended Practices for Optical Fiber Construction and Testing* published by the Society of Cable Telecommunications Engineers (SCTE) for further information.

### **7.6.1 Fiber Handling**

Often fiber optic cable must be unreeled before installation. SCTE recommends the figure-eight method to avoid twisting or bending. For shorter lengths of fiber cable (~2000 feet or 600 meters), remove the fiber cable from the reel, and coil it on the ground into a figure-eight configuration about 15 feet (4.5 meters) in length, with coils 5 feet (1.5 meters) in diameter. For longer lengths of fiber cable, coil the fiber cable into a figure-eight configuration about 30 feet (9 meters) in length, with coils 10 feet (3 meters) in diameter. Use cardboard shims between sections of fiber cable at the crossover locations of the figure-eight to relieve excess pressure.

Singlemode fiber, typically used in HFC architecture, is composed of an  $9\mu\text{m}$  glass core, surrounded by  $125\mu\text{m}$  of cladding, which protects the core and serves to bend the optical energy back into the core. The cladding is protected by a 1 mm plastic buffer coating. To ensure that the integrity of the cladding and glass core are maintained, proper handling of the fiber cable is required.

When installing fiber optic cables in ducts, on above-ground strands, or underground:

- do not exceed the fiber cable manufacturer's maximum pulling tension
- do not exceed the fiber cable manufacturer's minimum bending radius
- do not subject the fiber cable to crushing forces

If cable specification documents are not available from the system manager, pulling tension should not exceed 600 pounds (~273 kg) during installation of non-connectorized fiber optic cable. The general minimum bending radius for a fiber cable under tension is 20 times the diameter of the fiber cable. The general minimum bending radius for a fiber cable not under tension—and in fiber management within a fiber optic node—is 10 times the diameter of the fiber cable. When securing connectorized fiber leads within node housings with cable ties, use caution to avoid crushing the plastic buffer or cladding.

## 7.6.2 To Wet Clean Fiber Cable Connectors:

---



**DANGER:** Avoid direct exposure to laser radiation. Turn off lasers before cleaning and inspecting.

---



**CAUTION:** Improper cleaning can cause damage to equipment.

---

1. Turn off lasers before cleaning and inspecting.
2. Remove the fiber connector's dust cap.
3. Inspect the connector with a fiberscope.
4. Apply a few drops of 99% Isopropyl alcohol to lens paper which has been folded in 4 to 6 layers and laying flat on the table. Do not oversaturate.
5. Hold the connector vertically and clean it in a figure 8 motion.
6. Repeat the figure 8 wiping action with a dry lint-free wipe to remove any residual alcohol.
7. Inspect the connector again with a fiberscope.
8. Repeat the process if necessary.
9. Replace dust caps on optical fiber connectors until ready for connection.
10. Dispose of wipe, never reuse a wipe.

## 7.6.3 Cleaning Endface Connectors with Lint Free Swabs

Specially designed cleaning swabs/sticks are designed for dry cleaning fiber optic connector mating sleeves, bulkhead adapters and receptacles. This is considered an abrasive fiber optic cleaning method but the resilient stick head mitigates the abrasiveness.

To clean the endface of connectors already installed, you insert the cleaning swab/stick into the bulkhead adapter or receptacle, making sure the tip contacts the connector endface. Then,

complete a single turn of the cleaning swab/stick and then pull the stick out and dispose of it. You should never reuse a cleaning swab/stick.

1. Remove the protective endcaps.
2. Inspect the connector in the adapter or bulkhead with a fiberscope probe.
3. Insert the cleaning swab into the bulkhead adapter or receptacle, making sure the tip reaches the connector endface.
4. Turn the swab several complete revolutions in the same direction.
5. Inspect the connector again with a fiberscope probe.
6. Repeat the process if necessary.
7. Replace protective endcaps until ready for connection.

#### 7.6.4 To Clean Fiber Connectors with Reel Based Cleaners

Connector reel based cleaners are a dry cleaning method with a quick, reliable operation and uniform results. They consist of 2 micrometer weaved polyester cloths that clean optical fiber connectors with a ratcheting mechanism, sliding dust cover, and resilient pad. One reel cleaner tape can be used for over 400 cleanings.

This is considered an abrasive fiber optic cleaning method but the pad underneath the cleaning cloth mitigates this significantly. Newer versions may be available that are compatible with male ribbon connectors.



**DANGER:** Avoid direct exposure to laser radiation. Turn off lasers before cleaning and inspecting.



**CAUTION:** Improper cleaning can cause damage to equipment.

- 
1. Turn off lasers before cleaning and inspecting.
  2. Remove the fiber connector's dust cap.

3. Inspect the connector with a fiberscope.
4. If cleaning is needed, clean with a reel based cleaner:
  - For cartridge cleaners, press down and hold the thumb lever. A new cleaning area will now be available.
  - For pocket cleaners, remove the protective film to reveal a new cleaning surface.
  - For manual advance cleaners, pull on the bottom cleaning surface of the device until a new strip appears in the cleaning window.
5. Hold the fiber tip lightly against the cleaning area.



**CAUTION:** Do not scrub the fiber against the fabric or clean over the same surface more than once. This can cause contamination or damage to the connector.

---

6. Pull the fiber tip lightly down the new cleaning surface in the direction indicated or from top to bottom.
7. Inspect the connector again with a fiberscope.
8. Repeat the process if necessary.
9. Replace dust caps on optical fiber connectors until ready for connection

### 7.6.5 Cleaning FC Bulkhead Connectors

Optical bulkhead connectors are extremely fragile. After cleaning, use caution when joining fiber cable connectors to bulkhead connectors.

In particular, FC/UPC and FC/APC fiber connectors have special requirements. FC connectors must be installed into or removed from the bulkhead connector by unscrewing the retainer and inserting/withdrawing the fiber tip straight into or out of the bulkhead connector. The fiber tip must not be inserted or withdrawn at an angle. Inserting or withdrawing the fiber tip at an angle may damage the ceramic sleeve within the bulkhead connector. A damaged ceramic sleeve may completely inhibit laser signal transmission. All ceramic sleeves in FC/UPC and FC/APC connectors have a uniform slot running the length of the

sleeve. Do not mistake this manufactured slot for a crack, which will have uneven edges. An example of an unbroken ceramic sleeve and examples of damaged ceramic sleeves are shown below.

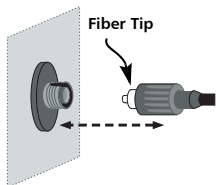

Fiber Tip

**Installing/removing  
fiber connector**

(ensure that fiber tip enters  
parallel to ceramic sleeve in  
bulkhead connector)

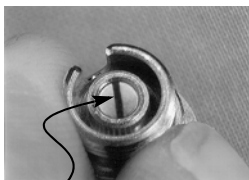

**Unbroken ceramic sleeve  
(with slot visible)**

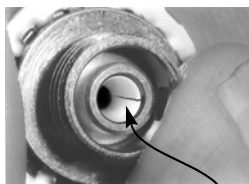

**Ceramic sleeve cracked**



**Section of ceramic sleeve broken  
out within the connector**

**FC Bulkhead connectors  
(Installation and Breakage Examples)**

## 7.6.6 To Clean Fiber Connectors with Compressed Air

---

**CAUTION:** To avoid damage to optical fiber, use compressed air with at least the following specifications:



- Non-residue, inert gas for precision dust removal
- Ultra-filtered to < 0.2 microns
- Recommended for optical systems.



**Note:** Follow the manufacturer's directions and cautions when using compressed air to clean fiber connectors. Do not tilt, invert, or shake the can of compressed air during use.

---

1. Remove the fiber connector's dust cap.
  2. Inspect the connector with a fiberscope.
  3. Hold the can of compressed air with the specifications above in an upright position, at an angle to the fiber tip, and about 6 inches away from the connector.
  4. After spraying a few short bursts at the fiber tip, the connector will be clean and ready for either optical power measurement or connection.
- 



**CAUTION: Received optical power greater than the specified maximum level can damage optical receivers.** Before connecting fiber cable connectors to forward receiver connectors, use an optical power meter to ensure that the received optical power is within the specified range.

---

5. Use an optical power meter to measure received optical power for the input fiber that is to be connected to the forward receiver. Clean the input fiber connector again.
6. Inspect the connector again with a fiberscope.
7. Replace dust caps on optical fiber connectors until ready for connection.

## 7.7 Wavelength Division Multiplexing Specifications

WDMs transmit two widely spaced wavelengths multiplexed onto one fiber.

### Specifications for ARRIS Wavelength Division Multiplexers (WDM)

Wavelengths	1310/1550 nm
Bandpass	$\pm 15$ nm
Insertion Loss	0.6 dB
Directivity	>55 dB
Isolation	>35 dB

## 7.8 Coarse Wavelength Division Multiplexing (CWDM)

Coarse Wavelength Division Multiplexing is the transmission of multiple optical signals on one fiber at different wavelengths, or channels. There are 18 CWDM wavelengths, spaced 20 nm apart, from 1271 nm to 1611 nm. The signals are combined for transmission by a multiplexer (mux) and separated at the receiving end by a demultiplexer (demux).

CWDM Wavelengths		
1271 nm	1391 nm	1511 nm
1291 nm	1411 nm	1531 nm
1311 nm	1431 nm	1551 nm
1331 nm	1451 nm	1571 nm
1351 nm	1471 nm	1591 nm
1371 nm	1491 nm	1611 nm



**Note:** The Coarse Wavelength Division Multiplexing transmission process typically requires two CWDMs—one to multiplex at the transmission end, and another to demultiplex at the receiving end.



## 7.9 Dense Wavelength Division Multiplexing (DWDM)

Dense WDMs use closely spaced wavelengths, making it possible to transmit multiple signals on the same fiber.

### 7.9.1 ITU-Grid Channels

ITU (International Telecommunications Union), headquartered in Geneva, Switzerland, is an international organization within which governments and the private sector coordinate global telecommunications networks and services. (For more information on ITU and its standards, go to [www.itu.int](http://www.itu.int).)

ITU channels consist of wavelengths ranging from 1517.94 to 1577.03 nm spaced in 100GHz frequency steps. The 16 most commonly used wavelengths are split into two 8-channel ranges which are referred to as *red* and *blue*. *Red* refers to the eight lower frequency (longer wavelength) ITU odd-numbered channels 21 (1560.61 nm) to 35 (1549.32 nm). *Blue* refers to the eight higher frequency (shorter wavelength) ITU odd-numbered channels 43 (1542.94 nm) to 57 (1531.90 nm).

The following table provides the entire ITU Grid. Sections 7.9.2 through 7.9.6 provide specifications on ARRIS DWDM multiplexers and demultiplexers based on the ITU Grid.

## ITU-Grid Channels

Channel	Frequency (GHz)	Wavelength (nm)	Channel	Frequency (GHz)	Wavelength (nm)	Channel	Frequency (GHz)	Wavelength (nm)
1	190,100	1,577.03	26	192,600	1,556.56	51	195,100	1,536.61
2	190,200	1,576.20	27	192,700	1,555.75	52	195,200	1,535.82
3	190,300	1,575.37	28	192,800	1,554.94	53	195,300	1,535.04
4	190,400	1,574.54	29	192,900	1,554.13	54	195,400	1,534.25
5	190,500	1,573.71	30	193,000	1,553.33	55	195,500	1,533.47
6	190,600	1,572.89	31	193,100	1,552.52	56	195,600	1,532.68
7	190,700	1,572.06	32	193,200	1,551.72	57	195,700	1,531.90
8	190,800	1,571.24	33	193,300	1,550.92	58	195,800	1,531.12
9	190,900	1,570.42	34	193,400	1,550.12	59	195,900	1,530.33
10	191,000	1,569.59	35	193,500	1,549.32	60	196,000	1,529.55
11	191,100	1,568.77	36	193,600	1,548.51	61	196,100	1,528.77
12	191,200	1,567.95	37	193,700	1,547.72	62	196,200	1,527.99
13	191,300	1,567.13	38	193,800	1,546.92	63	196,300	1,527.22
14	191,400	1,566.31	39	193,900	1,546.12	64	196,400	1,526.44
15	191,500	1,565.50	40	194,000	1,545.32	65	196,500	1,525.66
16	191,600	1,564.68	41	194,100	1,544.53	66	196,600	1,524.89
17	191,700	1,563.86	42	194,200	1,543.73	67	196,700	1,524.11
18	191,800	1,563.05	43	194,300	1,542.94	68	196,800	1,523.34
19	191,900	1,562.23	44	194,400	1,542.14	69	196,900	1,522.56
20	192,000	1,561.42	45	194,500	1,541.35	70	197,000	1,521.79
21	192,100	1,560.61	46	194,600	1,540.56	71	197,100	1,521.02
22	192,200	1,559.79	47	194,700	1,539.77	72	197,200	1,520.25
23	192,300	1,558.98	48	194,800	1,538.98	73	197,300	1,519.48
24	192,400	1,558.17	49	194,900	1,538.19	74	197,400	1,518.71
25	192,500	1,557.36	50	195,000	1,537.40	75	197,500	1,517.94

## 7.9.2 Upgradable/Non-Upgradable DWDMs

*Upgradable* DWDMs provide an extra input or output port for the insertion and transmission of a second band of wavelengths to be combined and separated by another DWDM. For example, an 8-channel upgradable, red DWDM multiplexer provides a ninth input port for the multiplexed blue channels from the output of a blue band multiplexer. The corresponding (red, upgradable) demultiplexer provides a ninth output port for the multiplexed blue channels to be input to a blue band demultiplexer. See the following table for the wavelengths and band of the common ITU channel numbers.

*Non-upgradable* DWDMs have no extra inputs/outputs and are therefore limited to transmitting/receiving only the 4-channel or 8-channel band specified when ordered.

### 7.9.3 4-Channel Non-Upgradable DWDM Specifications

The 4-channel non-upgradable DWDM provides four ITU channels in a choice of four bands—red/high, red/low, blue/high, and blue/low, as indicated below.

#### ARRIS 4-Channel Non-Upgradable DWDM<sup>1</sup>

ITU Channel Number	Center Wavelength (nm)	Band	Insertion Loss Typ/Max (dB)		
			Mux	Demux	Total
21	1560.61	red/high	1.6/2.0	1.2/1.5	3.0/3.7
23	1558.98		1.3/1.6	1.5/1.9	
25	1557.38		1.0/1.2	1.8/2.3	
27	1555.75		1.0/1.2	1.8/2.3	
29	1554.13	red/low	1.6/2.0	1.2/1.5	3.0/3.7
31	1552.52		1.3/1.6	1.5/1.9	
33	1550.92		1.0/1.2	1.8/2.3	
35	1549.32		1.0/1.2	1.8/2.3	
43	1542.94	blue/high	1.6/2.0	1.2/1.5	3.0/3.7
45	1541.35		1.3/1.6	1.5/1.9	
47	1539.77		1.0/1.2	1.8/2.3	
49	1538.19		1.0/1.2	1.8/2.3	
51	1536.61	blue/low	1.6/2.0	1.2/1.5	3.0/3.7
53	1535.04		1.3/1.6	1.5/1.9	
55	1533.47		1.0/1.2	1.8/2.3	
57	1531.90		1.0/1.2	1.8/2.3	

- Blue channel options also include blue/high channels 45 to 51 and blue/low channels 53 to 59 (1530.33nm).

### 7.9.4 8-Channel Non-Upgradable DWDM Specifications

The 8-channel, non-upgradable DWDM provides eight ITU channels in either the red band (ITU channels 21 to 35), or the blue band (ITU channels 43 to 57), as indicated below.

#### ARRIS 8-Channel Non-Upgradable DWDM

ITU Channel Number	Center Wavelength (nm)	Band	Insertion Loss Typ/Max (dB)		
			Mux	Demux	Total
21	1560.61	red	2.9/3.6	1.2/1.5	4.4/5.5
23	1558.98		2.5/3.2	1.6/1.9	
25	1557.38		2.2/2.8	1.9/2.3	
27	1555.75		2.2/2.8	2.1/2.7	
29	1554.13		1.9/2.4	2.5/3.1	
31	1552.52		1.6/2.0	2.8/3.5	
33	1550.92		1.2/1.6	3.1/3.9	
35	1549.32		1.0/1.2	3.1/3.9	
43	1542.94	blue	2.9/3.6	1.2/1.5	4.4/5.5
45	1541.35		2.5/3.2	1.6/1.9	
47	1539.77		2.2/2.8	1.9/2.3	
49	1538.19		2.2/2.8	2.1/2.7	
51	1536.61		1.9/2.4	2.5/3.1	
53	1535.04		1.6/2.0	2.8/3.5	
55	1533.47		1.2/1.6	3.1/3.9	
57	1531.90		1.0/1.2	3.1/3.9	

### 7.9.5 8-Channel Upgradable DWDM Specifications

The 8-channel upgradable DWDM mux is a red band mux (8RU—8-channel, red, upgradable) with a ninth input port to accommodate the input of the muxed output from an 8-channel, non-upgradable, blue band DWDM mux (8B). The two muxes combined provide inputs for 16 optic channels.

At the receiving end, the upgradable DWDM demux is a red band demux (8RU) with a ninth output port for the muxed blue band channels to be input to a non-upgradable, blue band demux (8B). The two demuxes combined provide output for 16 optic channels.

The red band insertion losses shown below are for the ARRIS upgradable red mux/demux (8RU). The blue band losses are for the upgradable red band mux/demux coupled with the blue band, non-upgradable mux/demux (8RU + 8B).

#### ARRIS 8/16-Channel Upgradable DWDM

ITU Channel Number	Center Wavelength (nm)	Band	Insertion Loss Typ/Max (dB)		
			Mux	Demux	Total
21	1560.61	red	3.6/4.6	2.0/2.5	6.0/7.5
23	1558.98		3.3/4.2	2.3/2.8	
25	1557.38		3.0/3.8	2.6/3.3	
27	1555.75		3.0/3.8	3.0/3.7	
29	1554.13		2.7/3.4	3.3/4.1	
31	1552.52		2.4/3.0	3.6/4.5	
33	1550.92		2.0/2.6	4.0/4.9	
35	1549.32		1.8/2.2	4.0/4.9	
43	1542.94	blue	3.6/4.6	2.0/2.5	6.0/7.5
45	1541.35		3.3/4.2	2.3/2.8	
47	1539.77		3.0/3.8	2.6/3.3	
49	1538.19		3.0/3.8	3.0/3.7	
51	1536.61		2.7/3.4	3.3/4.1	
53	1535.04		2.4/3.0	3.6/4.5	
55	1533.47		2.0/2.6	4.0/4.9	
57	1531.90		1.8/2.2	4.0/4.9	

### 7.9.6 16-Channel DWDM Specifications

The 16-channel DWDM mux provides inputs for the 8 red channels, 21 through 35, and 8 blue channels, either 43 through 57 or 45 through 59.

At the receiving end, the DWDM demux provides outputs for 16 optic channels.

Insertion losses for the ARRIS 16-channel DWDM are shown below.

**ARRIS 16-Channel DWDM<sup>1</sup>**

ITU Channel Number	Center Wavelength (nm)	Band	Insertion Loss Typ/Max (dB)		
			Mux	Demux	Total
21	1560.61	red	3.6/4.6	2.0/2.5	6.0/7.5
23	1558.98		3.3/4.2	2.3/2.8	
25	1557.38		3.0/3.8	2.6/3.3	
27	1555.75		3.0/3.8	3.0/3.7	
29	1554.13		2.7/3.4	3.3/4.1	
31	1552.52		2.4/3.0	3.6/4.5	
33	1550.92		2.0/2.6	4.0/4.9	
35	1549.32		1.8/2.2	4.0/4.9	
43	1542.94	blue	3.3/4.2	2.0/2.5	6.0/7.5
45	1541.35		3.0/3.8	2.3/2.9	
47	1539.77		2.7/3.4	2.6/3.3	
49	1538.19		2.7/3.4	3.0/3.7	
51	1536.61		2.4/3.0	3.3/4.1	
53	1535.04		2.0/2.6	3.6/4.5	
55	1533.47		1.7/2.2	4.0/4.9	
57	1531.90		1.4/1.8	4.0/4.9	

1. Blue channel options also include channels 45 to 59 (1530.33 nm).

### 7.9.7 Legacy Aurora DP95Dxx DWDM Demux Specifications

The DP95xx series of DWDM demultiplexers are available in 4, 8, 12, 16, 20, and 40 channel cassettes. ITU channels are spaced at 100 GHz on the ITU grid, as shown in the table that follows. Demux pigtail fibers are color-coded and individually labeled to ensure proper installation and wavelength management.

#### ITU 6.694 Wavelengths for DP95Dxx DWDM Passives

ITU Channel Plan									
<i>i</i> for xx=4	<i>i</i> for xx=8	<i>i</i> for xx=10	<i>i</i> for xx=12	<i>i</i> for xx=16	<i>i</i> for xx=20	<i>i</i> for xx=40	Ch #	Ch Freq. and wavelength per ITU G.694.1, 02/2012	
H							16	191.6 Thz	1564.679
							17	191.7 Thz	1563.863
							18	191.8 Thz	1563.047
							19	191.9 Thz	1562.233
J	K	2					20	192.0 Thz	1561.419
							21	192.1 Thz	1560.606
							22	192.2 Thz	1559.794
							23	192.3 THz	1558.983
K				A			24	192.4 THz	1558.173
							25	192.5 THz	1557.363
							26	192.6 THz	1556.555
							27	192.7 THz	1555.747
L		3					28	192.8 THz	1554.940
							29	192.9 THz	1554.134
							30	193.0 THz	1553.329
							31	193.1 THz	1552.524























## ITU 6.694 Wavelengths for DP95Dxx DWDM Passives

ITU Channel Plan															
<i>i</i> for xx=4	<i>i</i> for xx=8	<i>i</i> for xx=10	<i>i</i> for xx=12	<i>i</i> for xx=16	<i>i</i> for xx=20	<i>i</i> for xx=40	Ch #	Ch Freq. and wavelength per ITU G.694.1, 02/2012							
M	M	3		A		N	32	193.2 THz	1551.721						
							33	193.3 THz	1550.918						
							34	193.4 THz	1550.116						
							35	193.5 THz	1549.315						
N							N		U	36	193.6 THz	1548.515			
										37	193.7 THz	1547.715			
										38	193.8 THz	1546.917			
										39	193.9 THz	1546.119			
P	P	4								U		U	40	194.0 THz	1545.322
													41	194.1 THz	1544.526
			42		194.2 THz	1543.730									
			43		194.3 THz	1542.936									
R	S				U					U			44	194.4 THz	1542.142
													45	194.5 THz	1541.349
				46				194.6 THz	1540.557						
				47				194.7 THz	1539.766						

## ITU 6.694 Wavelengths for DP95Dxx DWDM Passives

ITU Channel Plan								
<i>i</i> for <i>xx</i> =4	<i>i</i> for <i>xx</i> =8	<i>i</i> for <i>xx</i> =10	<i>i</i> for <i>xx</i> =12	<i>i</i> for <i>xx</i> =16	<i>i</i> for <i>xx</i> =20	<i>i</i> for <i>xx</i> =40	Ch #	Ch Freq. and wavelength per ITU G.694.1, 02/2012
S	S	4					48	194.8 THz 1538.976
							49	194.9 THz 1538.186
							50	195.0 THz 1537.397
							51	195.1 THz 1536.609
T	U	5	A				52	195.2 THz 1535.822
							53	195.3 THz 1535.036
							54	195.4 THz 1534.250
							55	195.5 THz 1533.465
U							56	195.6 THz 1532.681
							57	195.7 THz 1531.898
							58	195.8 THz 1531.116
							59	195.9 THz 1530.334
V							60	196.0 THz 1529.553
							61	196.1 THz 1528.773
							62	196.2 THz 1527.994
							63	196.3 THz 1527.216

### 7.9.7.1 DP95D12\_D16 Fiber Pigtail Colors

xx = 12	xx = 16	Color Codes	
COM	COM		White
EXP	EXP		Black
UPG	UPG		Orange
TP Rx	TP Rx		Aqua
TP Tx	TP Tx		Rose
50	25		Black + white strip
51	26		White + black strip
52	27		Red + black strip
53	28		Blue + black strip
54	29		Green + black strip
55	30		Yellow + black strip
56	31		Orange + black strip
57	32		Brown + black strip
58	33		Rose + black strip
59	34		Slate + black strip
60	35		Violet + black strip
61	36		Aqua + black strip
	37		Red
	38		Blue
	39		Green
	40		Yellow

### 7.9.7.2 Fiber Pigtail Colors (DP95D04, DP95D08, DP95D20, and DP95D40)

	xx = 04	xx = 08	xx = 20	xx = 40	Color Codes			
COM						White		
EXP				N/A		Black		
UPG						Orange		
TP Rx						Aqua		
TP Tx						Rose		
16	H					Red		
17						Black		
18						Yellow		
19						Violet		
20	J	K	N	U		Blue		
21						Orange		
22						Green		
23						Brown		
24	K							Slate
25								White
26								Red
27								Black
28	L	M	N	U		Yellow		
29						Violet		
30						Blue		
31						Orange		
32	M							Green
33						Brown		
34						Slate		
35						White		
36	N	P	N	U		Red		
37						Black		
38						Yellow		
39						Violet		
40	P							Blue
41						Orange		
42						Green		
43						Brown		

	xx = 04	xx = 08	xx = 20	xx = 40	Color Codes	
44	R	S	U	U		Slate
45						White
46						Red
47						Black
48	S					Yellow
49						Violet
50						Blue
51						Orange
52	T	U				Green
53						Brown
54						Slate
55						White
56	U					Red
57						Black
58						Yellow
59						Violet

## 7.10 Optical Modulation Index (OMI)

Optical Modulation Index (OMI) is a parameter that describes the amount of amplitude modulation applied to an optical transmitting device. An optical transmitter (typically a laser) can exist at full brightness, fully off (dark), or anywhere in between. The modulating signal causes changes in optical intensity proportional to the modulating amplitude.

OMI can be considered the RF "drive" into the laser. The higher the drive, the greater the OMI. Higher OMI results in higher RF output from the receiver and improved CNR performance. Like anything else, there are practical limits to how high the OMI can go.

With a typical CATV spectrum modulating the laser, the OMI must be adjusted to prevent laser clipping. Laser clipping occurs at 100% OMI. With 80 or more channels operating, several individual signals will be at peak amplitude at any given time. Several others will be at minimum and still others will be somewhere in between. For that reason, it is impossible to predict the exact instantaneous power of the applied signal at any point in time. Therefore, the total OMI of the laser must be limited to around 25%. This allows a margin for several signals to peak simultaneously. The statistical probability is such that the laser will not clip when all the channels are additively combined.

OMI is often discussed in terms of total OMI (RMS) or OMI per channel. Total OMI is simply the OMI created by the application of the entire headend spectrum. This is the parameter that should be limited to 25%. OMI/channel is the amount of modulation caused by one of the many channels. The only time total OMI equals OMI/channel is when only one channel is being transported.

It would seem logical that the OMI/channel is simply the total OMI divided by the number of channels. Because of the random nature of how the signals will combine from a power perspective, however, the OMI/channel is actually calculated by the following equations. Note that these equations are for a theoretical system without ingress, burst noise, etc. that would eat up the RF modulation margin when present.

$$\text{OMI}_{\text{PC}} = \sqrt{\frac{2}{N}} \cdot \text{OMI}_{\text{Total}}$$

Where  $\text{OMI}_{\text{PC}}$  = Per channel Optical Modulation Index (%)

$N$  = Number of Carriers at Tx input

$\text{OMI}_{\text{Total}}$  = Total Optical Modulation Index (%)

For example, if the total OMI is 25% and there are 80 channels, the OMI/channel would be:

$$\text{OMI}_{\text{PC}} = \sqrt{\frac{2}{80}} \cdot 25 = 3.95\% \text{ per channel}$$

Use the following equation to calculate the total OMI % if the OMI per channel % and number of channels are known.

$$\text{OMI}_{\text{Total}} = \sqrt{\frac{N}{2}} \cdot \text{OMI}_{\text{PC}}$$

Where  $\text{OMI}_{\text{Total}}$  = Total OMI in Percent (%)

$N$  = Number of Carriers at Tx input

$\text{OMI}_{\text{PC}}$  = Per channel Optical Modulation Index (%)

Useful OMI Relationships

- As OMI increases, receiver output increases if:
  - the receiver's laser is operating in the linear operating region
  - The receiver's AGC is off/disabled
- As OMI increases, CNR performance improves
- As OMI increases, distortion performance typically declines
- The relationship between OMI and RF output is a 20 log function. Therefore, doubling OMI results in a 6 dB increase in RF at the receiver and reducing OMI in half results in a 6 dB decrease in RF at the receiver.

### 7.10.1 Additional Useful OMI Equations

The maximum transmitter drive level that will keep the Composite OMI ( $OMI_{RMS}$ ) below 25% can be determined by the following equation.

$$V_{MAX} = V_{REF} - 20 \cdot \log\left(\sqrt{8 \cdot N} \cdot \frac{OMI_{PC-REF}}{100}\right)$$

Where  $V_{MAX}$  = Tx input that will keep  $OMI_{RMS} < 25\%$  (dBmV)

$V_{REF}$  = Reference Level at Tx input (dBmV)

$N$  = Number of Carriers at Tx input

$OMI_{PC-REF}$  = Reference Per channel OMI (%)

The RF output of a receiver is related to the OMI by the following equation.

$$V_{RX} = Ref_{OL} + 2 \times (Opt_{IL} - Ref_{IL}) + 20 \log_{10}\left(\frac{OMI_{Act}}{OMI_{Ref}}\right)$$

Where  $V_{RX}$  = Level at Rx output (dBmV)

$Ref_{OL}$  = Rx Reference Output Level (dBmV)

$Opt_{IL}$  = Rx Optical Input Level (dBm)

$Ref_{IL}$  = Rx Reference Optical Input Level (dBm)

$OMI_{Act}$  = Actual Per Channel OMI (%)

$OMI_{Ref}$  = Reference Per Channel OMI (%)

The change in receiver output is related to a change in OMI by the following equation.

$$V_2 = 20 \cdot \log\left(\frac{OMI_{PC-2}}{OMI_{PC-REF}}\right) + V_{REF}$$

Where  $V_2$  = New level at Rx output (dBmV)

$V_{REF}$  = Reference level at Rx output (dBmV)

$OMI_{PC-2}$  = New per channel OMI (%)

$OMI_{PC-REF}$  = Reference per channel OMI (%)



The change in transmitter OMI is related to a change in drive level by the following equation.

$$\text{OMI}_{\text{PC-2}} = 10^{\left(\frac{V_2 - V_{\text{REF}}}{20}\right)} + \text{OMI}_{\text{PC-REF}}$$

**Where  $V_2$  = New level at Tx input (dBmV)**

**$V_{\text{REF}}$  = Reference level at Tx input (dBmV)**

**$\text{OMI}_{\text{PC-2}}$  = New per channel OMI (%)**

**$\text{OMI}_{\text{PC-REF}}$  = Reference per channel OMI (%)**

## 7.11 dBm Conversions

dBm	mW	mV <sup>1</sup>	dBmV <sup>1</sup>
-13	0.05	61.31	35.75
-12	0.06	68.79	36.75
-11	0.08	77.18	37.75
-10	0.10	86.60	38.75
-9	0.13	97.16	39.75
-8	0.16	109.02	40.75
-7	0.20	122.32	41.75
-6	0.25	137.25	42.75
-5	0.32	153.99	43.75
-4	0.40	172.78	44.75
-3	0.50	193.87	45.75
-2	0.63	217.52	46.75
-1	0.79	244.06	47.75
0	1.00	273.84	48.75
1	1.26	307.26	49.75
2	1.58	344.75	50.75
3	2.00	386.81	51.75
4	2.51	434.01	52.75
5	3.16	486.97	53.75
6	3.98	546.39	54.75
7	5.01	613.06	55.75
8	6.31	687.86	56.75
9	7.94	771.79	57.75
10	10.00	865.96	58.75
11	12.59	971.63	59.75

1. Assumes a 75Ω system.

### mW - dBm Conversion Equation

$$10 \log (\text{value in mW}) = \text{value in dBm}$$

### dBm to dBmV Conversion Equation

$$\text{Value in dBmV} = \text{Value in dBm} + 48.75$$

## 7.12 Test Point DC Voltage Reference

mW	dBm	10 V/ 1 mW	4 V/ 1 mW	1 V/ 1 mW	0.5 V= 1 mW	0.2 V/ 1 mW	0.1 V/ 1 mW
0.1	-10.00	1.00	0.40	0.10	0.05	0.02	0.01
0.2	-6.99	2.00	0.80	0.20	0.10	0.04	0.02
0.3	-5.23	3.00	1.20	0.30	0.15	0.06	0.03
0.4	-3.98	4.00	1.60	0.40	0.20	0.08	0.04
0.5	-3.01	5.00	2.00	0.50	0.25	0.10	0.05
0.6	-2.22	6.00	2.40	0.60	0.30	0.12	0.06
0.7	-1.55	7.00	2.80	0.70	0.35	0.14	0.07
0.8	-0.97	8.00	3.20	0.80	0.40	0.16	0.08
0.9	-0.46	9.00	3.60	0.90	0.45	0.18	0.09
1.0	0.00	10.00	4.00	1.00	0.50	0.20	0.10
1.1	0.41	11.00	4.40	1.10	0.55	0.22	0.11
1.2	0.79	12.00	4.80	1.20	0.60	0.24	0.12
1.3	1.14	13.00	5.20	1.30	0.65	0.26	0.13
1.4	1.46	14.00	5.60	1.40	0.70	0.28	0.14
1.5	1.76	15.00	6.00	1.50	0.75	0.30	0.15
1.6	2.04	16.00	6.40	1.60	0.80	0.32	0.16
1.7	2.30		6.80	1.70	0.85	0.34	0.17
1.8	2.55		7.20	1.80	0.90	0.36	0.18
1.9	2.79		7.60	1.90	0.95	0.38	0.19
2.0	3.01		8.00	2.00	1.00	0.40	0.20
2.5	3.98		10.00	2.50	1.25	0.50	0.25
3.0	4.77		12.00	3.00	1.50	0.60	0.30
3.5	5.44		14.00	3.50	1.75	0.70	0.35
4.0	6.02		16.00	4.00	2.00	0.80	0.40
4.5	6.53			4.50	2.25	0.90	0.45
5.0	6.99			5.00	2.50	1.00	0.50
5.5	7.40			5.50	2.75	1.10	0.55
6.0	7.78			6.00	3.00	1.20	0.60
6.5	8.13			6.50	3.25	1.30	0.65
7.0	8.45			7.00	3.50	1.40	0.70
7.5	8.75			7.50	3.75	1.50	0.75

## 7.12 Test Point DC Voltage Reference

mW	dBm	10 V/ 1 mW	4 V/ 1 mW	1 V/ 1 mW	0.5 V= 1 mW	0.2 V/ 1 mW	0.1 V/ 1 mW
8.0	9.03			8.00	4.00	1.60	0.80
8.5	9.29			8.50	4.25	1.70	0.85
9.0	9.54			9.00	4.50	1.80	0.90
9.5	9.78			9.50	4.75	1.90	0.95
10.0	10.00			10.00	5.00	2.00	1.00
10.5	10.21			10.50	5.25	2.10	1.05
11.0	10.41			11.00	5.50	2.20	1.10
11.5	10.61			11.50	5.75	2.30	1.15
12.0	10.79			12.00	6.00	2.40	1.20
12.5	10.97			12.50	6.25	2.50	1.25
13.0	11.14			13.00	6.50	2.60	1.30
13.5	11.30			13.50	6.75	2.70	1.35
14.0	11.46			14.00	7.00	2.80	1.40
14.5	11.61			14.50	7.25	2.90	1.45
15.0	11.76			15.00	7.50	3.00	1.50
15.5	11.90			15.50	7.75	3.10	1.55
16.0	12.04			16.00	8.00	3.20	1.60
16.5	12.17				8.25	3.30	1.65
17.0	12.30				8.50	3.40	1.70
17.5	12.43				8.75	3.50	1.75
18.0	12.55				9.00	3.60	1.80
18.5	12.67				9.25	3.70	1.85
19.0	12.79				9.50	3.80	1.90
19.5	12.90				9.75	3.90	1.95
20.0	13.01				10.00	4.00	2.00

# Packet Transport (MPEG/IP)

IPv6

IPv4 Subnetting Charts

T1/E1

MOCA

IP Protocols

MPEG

Ethernet and Wireless Standards

## 8.1 SONET OC

The Synchronous Optical Network (SONET) Optical Carrier (OC) standard is specified for North America based on building blocks in increments of 51.84Mbps. The international counterpart is known as the Synchronous Digital Hierarchy (SDH) based on building blocks of 155.52Mbps, designated Synchronous Transport Module level 1 (STM-1).

<b>SONET Bit Rates</b>			©SCTE
SONET	SDH	Bit Rate (Mbps)	Bit Rate (Gbps)
OC-1		51.84	0.05184
OC-3/3C	STM-1	155.52	0.15552
OC-12	STM-4	622.08	0.62208
OC-48	STM-16	2488.32	2.48832
OC-192	STM-64	9953.28	9.95328
OC-768	STM-256	39813.12	39.81312

## 8.2 T1-E1

The T-carrier system (Trunk) is the designator for any of several digitally multiplexed telecommunications carrier systems used in North America, Japan, and South Korea. The basic unit of the T-carrier is the DS0, which represents a transmission rate of 64 kbps and is commonly used for one voice circuit. The T1 format consists of 24 DS0 units for a capacity of 1.544 Mbps.

The E-carrier system (Europe) published by the ITU also uses 64 kbps as the basic unit (DS0). The E1 format consists of 32 DS0 units for a capacity of 2.048 Mbps. Refer to the following table for the other various formats.

<b>Digital Signal Capacity</b>				©SCTE
Level	America (Mbps)	Europe (Mbps)	Japan (Mbps)	
0	0.064	0.064	0.064	
1	1.544	2.048	1.544	
2	6.312	8.448	6.312 or 7.786	
3	44.736	34.368	32.064	
4	274.176	139.264	97.728	
5	400.352	565.148	565.148	

### 8.3 Cable Modems and eMTAs

The following table provides the recommended CPE power levels and RF specification for cable modems and eMTAs.

Power Levels						@SCTE
	Analog Low (dBmV)	Analog High (dBmV)	DS Digital Low (dBmV)	DS Digital High (dBmV)	US Digital Low (dBmV)	US Digital High (dBmV)
Tap	Optimal	20	15	20		
	Satisfactory	10	10	15		
	Borderline	5	10	10		
Ground Block	Optimal	10	10	15		
	Satisfactory	5	10	10		
	Borderline	0	5	5		
CPE	Optimal	5	-4	4	> 35	< 44
	Satisfactory	0	5	> 4 and < 8	30	49

Digital CPE Specifications						@SCTE
	Pre FEC BER	Post FEC BER	US CWER	DS CWER	DS SNR	US SNR
CPE	33dB or >	1.0E-09	0.0E-00	<.000003	<.0000003	31dB or >
* T3 Timeouts < 4 (Range request to CMTS failed)						
* T4 Timeouts = 0 (Keepalive from CMTS not ack'ed (16 missed, CM resets)						

### 8.4 OSI Model

The Open Systems Interconnection (OSI) reference model represents the seven layers of processing in which data is packaged and transmitted from a sending application to the receiving application. The networking framework passes control from one layer to the next, starting at the Application layer, and going to the bottom layer, Physical. It then goes over the channel to the next station and back up the hierarchy of levels.



## Open Systems Interconnection (OSI) Model

DoD Layer	OSI Layer	Layer Number	Protocol Data Unit	Protocols	Function	Hardware
Application	Application	Layer 7		DNS; TFTP; HTTPS; VTP; DHCP; SNMP; SMTP; FTP; HTTP;	Network services to the end user applications	Gateway
	Presentation	Layer 6	Data	Encryption; SSL; Graphics; Audio; Text; Compression	Data format coding, conversion and compression	Gateway
	Session	Layer 5		NetBIOS; Duplexing; RPC	Establish, manage, maintain and terminate communication sessions	Gateway
Host to Host	Transport	Layer 4	Segments	TCP; UDP	Responsible for both reliable and unreliable end to end data flow	Advanced Cable Tester; Gateway
Internetwork / Internet	Network	Layer 3	Datagrams	IPv4; IPv6; IPSec; ICMP; ARP; ND; IGMP; MLD	Routing, path determination and logical addressing	Router
Network Access	Data Link	Layer 2	Frames	MPEG; DOCSIS; SoNET	Framing of bits and physical addressing	Switch; NIC
				Ethernet	Logical Link Control (LLC) Access to the medium	
	Physical	Layer 1	Bits	RF; Voltage; Light; Multiplexing; Modulation; Encoding; Coaxial; Twisted Pair; Fiber Optic	Defines the cable or physical medium	Hub; Amplifier; Line Extender; Oscilloscope

© 2010 by SCTE

Mnemonic for the 7 OSI reference model layers (Please Do Not Touch Steve's Pet Alligator)

## 8.5 Ethernet Frames

The following diagrams show the ethernet IEEE 802.3 frame structure without and with the VLAN802.1Q tag.

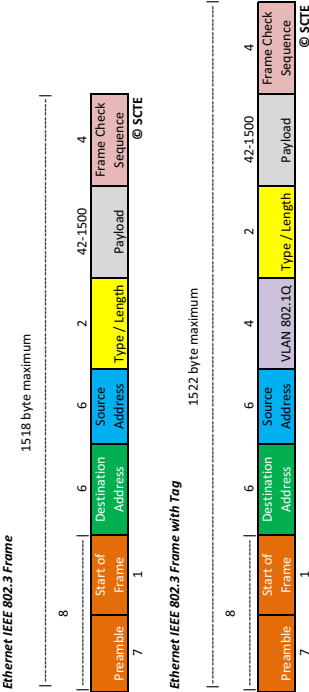

Field	Length (bytes)	Description
Preamble	7	Synchronizes communication
Start Frame Delimiter	1	Signals the start of a valid frame
Destination Address	6	Destination MAC address
Source Address	6	Source MAC address
802.1Q Tag	4	Optional VLAN tag
Ethertype or Length	2	Payload type or frame size
Payload	42-1500	Data payload
Frame Check Sequence	4	Frame error check or CRC
Interframe Gap	12	Required idle period between frames

© SCTE

## 8.6 Ethernet Bit Rates

The table below displays the Ethernet Bit Rates.

EUI-48				©SCTE
Ethernet, Adapter, Node, Physical, MAC and Burned In Address				
12	34	56	78	90 AA
Manufacturer				Unique Serial

Ethernet Bit Rates				©SCTE
Name	Standard	Bit Rate (Mbps)	Bit Rate (Gbps)	Description
10Base-T	802.3	10	0.01	Cat #3 two pair cable
100Base-T	802.3u	100	0.1	Category #3 four pair cable, Cat #5 two pair cable
1000Base-SX	802.3z	1000	1	850nm over MMF
1000Base-LX	802.3z	1000	1	1300nm over MMF or SMF
1000Base-T	802.3ab	1000	1	Category #5/5e four pair cable
10 Gige	802.3ae	10000	10	850nm over MMF; 1310 and 1550nm over SMF

## 8.7 Ethernet Activation Testing

The following table lists the tests associated with IETF RFC 2544 and ITU-T Y.1564 standards.

Tests	IETF RFC 2544	ITU-T Y.1564
Service Activation	x	x
Throughput	x	x
Frame delay	x	x
Frame loss	x	x
Frame Delay Variation (FDV) / Jitter		x
Multiple Simultaneous Stream Testing		x
Latency on every frame		x
Service Level Agreement (SLA) Specific Items (e.g., CIR, CBS, EIR, EBS & CM)		x
© SCTE		

Committed Information Rate (CIR)

Committed Burst Size (CBS)

Excessive Information Rate (EIR)

Excessive Burst Size (EBS)

Color Mode (CM)

## 8.8 MPEG PSI

Program Specific Information (PSI) is the MPEG 2 data that identifies what parts of the transport stream belong to a particular program. The following table provides a brief summary of the four PSI tables associated with MPEG video.

MPEG Program Specific Information Table		©SCTE
PSI Tables	Description	PID
<b>Program Association Table (PAT)</b>	The first step to decode video, extract packets with PID 0 to build table. The table lists all the maps for programs. A programs content will be mapped in the PMT under a PID value. The table may also include the PID value for packets encapsulating the NIT which the contents and use are specified in DVB.	0x0000
<b>Conditional Access Table (CAT) optional</b>	Using Entitlement Management Messages (EMMs) cable operators have the ability to transmit proprietary conditional access information. Provides the location of EMMs in the transport stream.	0x0001
<b>Program Map Table (PMT)</b>	PMT contains the mapping for the elements of a program. The elements include the video, audio, data, stuffing and 27MHz PCR PID values.	Encapsulated in PAT
<b>Network Information Table (NIT) optional</b>	Details of other transport streams that may be available to the same decoder of a DVB network topology. Shows topology of the transport streams carried over the network.	e.g. 0x0010 DVB
PID = Packet Identifier, PCR = Program Clock Reference		
DOCSIS PID = 0x1FFE		

## 8.9 MPEG header

The top row of the following figure shows the basic structure of an MPEG transport packet which has a fixed size of 188 bytes that includes the 4 byte header. The second row shows all of the elements that form the 4 byte (32 bit) packet header.

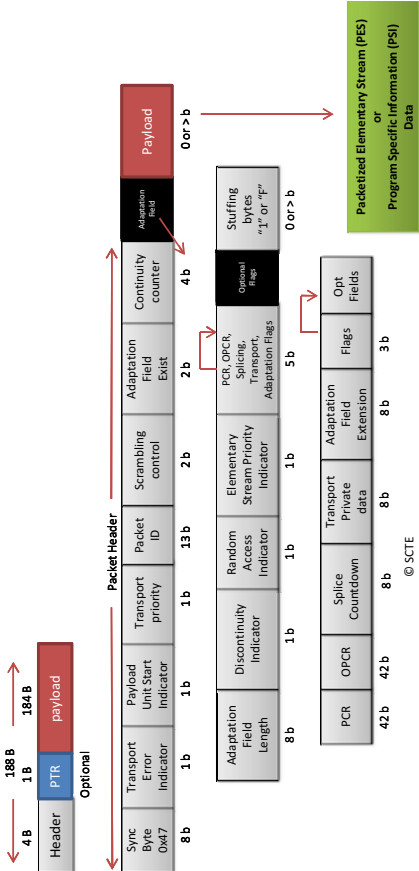

## 8.10 IPv4 header

The IPv4 header is shown in the following datagram and the fields are described in the following table.

IPv4 Header				©SCTE
Version	IHL	Type of Service	Total Length	
Identification		Flags	Fragment Offset	
Time to Live	Protocol	Header Checksum		
Source Address				
Destination Address				
Options			Padding	

### IPv4 Header Field Descriptions

Version—	Internet Protocol Version
Internet Header Length (IHL)—	4-bit field telling the number of 32-bit words in the header. The minimum value is 5 (160 bits) and the maximum value is 15 (480 bits).
Type of Service—	A field designed to carry information to provide quality of service features, such as prioritized delivery. The field where Per Hop Behaviors are added such as DSCP.
Total Length—	This 16-bit field defines the datagram size, including the header and data, in bytes. The minimum length datagram is 20 bytes and the maximum size is 65,535 bytes.
Identification—	Primarily used for uniquely identifying fragments of an original IP datagram.
Flags—	A 3-bit field that used to control or identify fragments. They are in order from high to low. <ul style="list-style-type: none"><li>■ bit 0: Reserved, must be zero</li><li>■ bit 1: Don't Fragment (DF)</li><li>■ bit 2: More Fragments (MF)</li></ul>
Fragment Offset—	A 13-bit field that specifies the number of 8-byte blocks to offset a particular fragment

## IPv4 Header Field Descriptions (cont'd)

---

Time to Live	Specifies how long the datagram is allowed to “live” on the network, in terms of router hops. Each router decrements the value of the TTL field (reduces it by one) prior to transmitting it. If the TTL field drops to zero, the datagram is assumed to have taken too long a route and is discarded.
Protocol	Identifies the higher-layer protocol carried in the datagram.
Header Checksum	A checksum computed over the header to provide basic protection against corruption in transmission.
Source Address	The 32-bit IP address of the originator of the datagram
Destination Address—	The 32-bit IP address of the intended recipient of the datagram.
Options—	
Padding—	If one or more options are included, and the number of bits used for them is not a multiple of 32, enough zero bits are added to “pad out” the header to a multiple of 32 bits (4 bytes).

---



## 8.11 IPv6 header

The IPv6 header is shown in the following datagram and the fields are described in the following table.

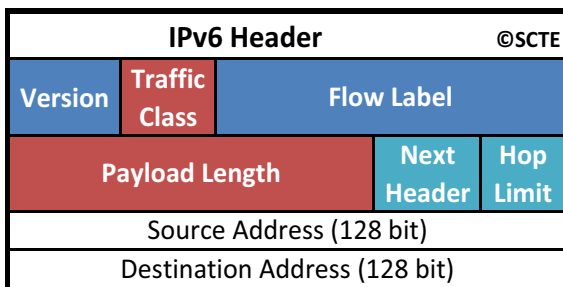

### IPv6 Header Field Descriptions

Version —	Internet Protocol Version
Traffic Class —	Similar to the IPv4 precedence and TOS, priority for congestion control
Flow Label —	Label a sequence of packets as being in the same flow
Payload length —	Number of bytes in everything following the 40 byte header, 0 for a jumbogram
Next Header —	Similar to the IPv4 “protocol” field - indicates what type of header follows the IPv6 header
Hop Limit —	Similar to the IPv4 TTL field, really means hops (not time)
Source Address —	128 bit hexadecimal address
Destination Address —	128 bit hexadecimal address

### IPv6 Next Header

Protocol	Field	Protocol	Field
041	IPv6 main	017	UDP
000	Hop by hop	046	RSVP
060	Destination options	047	GRE
043	Routing header	055	MOBILE
044	Fragment header	058	ICMPv6

## IPv6 Next Header (cont'd)

Protocol	Field	Protocol	Field
051	Authentication header (IPSec-AH)	089	OSPF IGP
050	Encapsulation header (IPSec-ESP)	094	IP within IP encapsulation
059	No Next Header	103	PIM
002	IGMP	135	Mobility header
006	TCP		

© SCTE

### 8.12 TCP header

The Transmission Control Protocol (TCP) header is shown in the following datagram and the fields are described in the following table.

TCP Header				© SCTE
Source Port		Destination Port		
Sequence Number				
Acknowledgement Number				
Offset	Reserved	Flags	Window	
Checksum			Urgent Pointer	
Options			Padding	

### TCP Header Field Descriptions

Source Port—	Port number of the originating station.
Destination Port—	Port number of the destination station.
Sequence Number—	Number assigned to a TCP datagram to indicate the beginning byte number of a packet, unless the SYN bit is set. If this bit is set, the sequence number is the initial sequence number (ISN) and the first data byte is ISN + 1.
Acknowledgement Number—	Number sent by the destination station to the source station, indicating acknowledgment of a previously received packet or packets. This number indicates the next sequence number the destination station should receive.

## TCP Header Field Descriptions (cont'd)

Offset—	Indicates length of the TCP header, in 32-bit words.
Reserved—	For future use. Must be set to 0.
Flags—	Used for various control functions.
Window—	Number of data octets, beginning with the one indicated in the acknowledgment field, that the sender of this segment is willing to receive.
Checksum—	An error detection number.
Urgent Pointer	Points to the sequence number of the byte following the urgent data. This field is interpreted only in segments with the URG bit set.
Options	Allow one of the following TCP options: end of option list, no operation, or maximum segment size.
Padding—	zero bits are padded so the header ends at a 32-bit boundary.

### 8.13 UDP Header

The User Datagram Protocol (UDP) header is shown in the following datagram and the fields are described in the following table.

UDP Header		© SCTE
Source Port	Destination Port	
Length	Checksum	

### UDP Header Field Descriptions

Source Port—	Port number of the originating station.
Destination Port—	Port number of the destination station.
Length—	Indicates total number of bytes in the complete UDP datagram (header + data).
Checksum—	Used for error-checking of the header and data.

## 8.14 IPv4 Classes

IPv4 address space can be divided into 5 classes:

- Class A — 0.0.0.0 to 127.255.255.255 address range where 0.0.0.0 is the gateway of last resort and 127.0.0.1 to 127.255.255.254 is local loopback (Common practice is to use on IP networks)
- Class B — 128.0.0.0 to 191.255.255.255 address range (Common practice is to use on IP networks)
- Class C — 192.0.0.0 to 223.255.255.255 address range (Common practice is to use on IP networks)
- Class D — 224.0.0.0 to 239.255.255.255 address range (Common practice is to reserve for multicast networks)
- Class E — 240.0.0.0 to 255.255.255.255 address range where 255.255.255.255 is the broadcast address to all networks (These are RESERVED addresses)

IPv4 Classes						©SCTE
Bits	0	8	16	24	32	
Class A	0	Network ID		Host ID		
Class B	1	0	Network ID		Host ID	
Class C	1	1	0	Network ID		Host ID
Class D	1	1	1	0	Multicast	
Class E	1	1	1	1	0	Reserved

## 8.15 IPv4 Subnetting

IPv4 subnetting allows you to improve efficiency in your network by subdividing your IP network. Subnetting is performed by dividing your IP network into subgroups by the routing prefix in the IP address (CIDR) and bit grouping. See the following table for more information on IPv4 subnetting.

Subnetting Chart											©SCTE			
CIDR /	Mask				Host	Networks	Subnets/ Class	Class A Subnets	Class B Subnets	Wild Card Mask				
32	255	255	255	255	—	—	—	—	—	0	0	0	0	
31	255	255	255	254	0	—	128	8388608	32768	0	0	0	1	
30	255	255	255	252	2	—	64	4194304	16384	0	0	0	3	
29	255	255	255	248	6	—	32	2097152	8192	0	0	0	7	
28	255	255	255	240	14	—	16	1048576	4096	0	0	0	15	
27	255	255	255	224	30	—	8	524288	2048	0	0	0	31	
26	255	255	255	192	62	—	4	262144	1024	0	0	0	63	
25	255	255	255	128	126	—	2	131072	512	0	0	0	127	
24	255	255	255	0	254	2097152	1	65536	256	0	0	0	255	
23	255	255	254	0	510	—	128	32768	128	0	0	1	255	
22	255	255	252	0	1022	—	64	16384	64	0	0	3	255	
21	255	255	248	0	2046	—	32	8192	32	0	0	7	255	
20	255	255	240	0	4094	—	16	4096	16	0	0	15	255	
19	255	255	224	0	8190	—	8	2048	8	0	0	31	255	
18	255	255	192	0	16382	—	4	1024	4	0	0	63	255	
17	255	255	128	0	32766	—	2	512	2	0	0	127	255	
16	255	255	0	0	65534	16384	1	256	1	0	0	255	255	
15	255	254	0	0	131070	—	128	128	—	0	1	255	255	
14	255	252	0	0	262142	—	64	64	—	0	3	255	255	
13	255	248	0	0	524286	—	32	32	—	0	7	255	255	
12	255	240	0	0	1048574	—	16	16	—	0	15	255	255	
11	255	224	0	0	2097150	—	8	8	—	0	31	255	255	
10	255	192	0	0	4194302	—	4	4	—	0	63	255	255	
9	255	128	0	0	8388606	—	2	2	—	0	127	255	255	
8	255	0	0	0	16777214	128	1	1	—	0	255	255	255	
7	254	0	0	0	—	—	—	—	—	1	255	255	255	
6	252	0	0	0	—	—	—	—	—	3	255	255	255	
5	248	0	0	0	—	—	—	—	—	7	255	255	255	
4	240	0	0	0	—	—	—	—	—	15	255	255	255	
3	224	0	0	0	—	—	—	—	—	31	255	255	255	
2	192	0	0	0	—	—	—	—	—	63	255	255	255	
1	128	0	0	0	—	—	—	—	—	127	255	255	255	

## 8.16 Decimal/Binary/Hexadecimal

This table shows the corresponding numerical equivalents between decimal (base 10), binary (base 2), and hexadecimal (base 16, with the letters A through F standing for the digits 11 through 16).

Decimal	Binary	Hex
1	1	1
2	10	2
3	11	3
4	100	4
5	101	5
6	110	6
7	111	7
8	1000	8
9	1001	9
10	1010	A
11	1011	B
12	1100	C
13	1101	D
14	1110	E
15	1111	F
©SCTE		

## 8.17 IPv6 Addressing

This table shows how some IPv6 addressing locations match up with their IPv4 equivalents. The IPv6 header is a fixed length of 40 bytes.

IPv6 Addressing			© SCTE
Address Type	Binary Prefix	Hex Prefix	IPv4 Equivalent
Global Unicast	0010	2000::<3	Public Addresses
Unique-Local (Site)	1111 1110	FC00::<7	RFC 1918 Addresses
	1111 1101	FD00::<8	10.0.0.0 - 10.255.255.255 172.16.0.0 - 172.32.255.255 192.168.0.0 - 192.168.255.255
Link-Local	1111 1110 10	FE80::<10	169.254.0.0 - 169.254.255.255
Unspecified	0000 ... 0	::/128	0.0.0.0
Multicast	1111 1111	FF00::<8	224.x.x.x
Loopback	0000 ... 1	::1/128	127.x.x.x
Anycast	unicast address assigned to multiple interfaces		
IPv4 Mapped	0:0:0:0:FFFF:x.x.x.x		
6to4	2002::<16		



## 8.18 IPv6 Multicast Addresses

Multicast is the transmission of a packet to multiple destinations in a single send operation. Multicast is part of the base specification in IPv6. In IPv4, this has an optional implementation, but it is still common. IPv6 does not transmit a packet to all hosts on the attached link using a special broadcast address, and does not define broadcast addresses. The following table gives the descriptions of the IPv6 Multicast types.

IPv6 Multicast Addresses			©SCTE	
Address	Compressed Address	Description	Scope	
FF01:0:0:0:0:0:1	FF01::1	All Nodes	Node-Local	
FF02:0:0:0:0:0:1	FF02::1	All Nodes	Link-Local	
FF01:0:0:0:0:0:2	FF01::2	All Routers	Node-Local	
FF02:0:0:0:0:0:2	FF02::2	All Routers	Link-Local	
FF05:0:0:0:0:0:2	FF05::2	All Routers	Site-Local	
FF02:0:0:0:0:0:5	FF02::5	OSPF Routers	Link-Local	
FF02:0:0:0:0:0:6	FF02::6	OSPF Designated Router (DR)	Link-Local	
FF02:0:0:0:0:0:9	FF02::9	RIP Routers	Link-Local	
FF02:0:0:0:0:0:1:2	FF02::1:2	All DHCP Servers and Agents	Link-Local	
FF05:0:0:0:0:0:1:3	FF05::1:3	All DHCP Servers	Site-Local	
FF02:0:0:0:0:1:FFxx:xxxx	FF02::1:FFxx:xxxx	Solicited Node Multicast	Link-Local	



### 8.19 Fiber Colors

The color coding used in fiber optics generally uses a 12-color sequence. The table below shows the number of a cable based on its color for larger groupings that use a 12-color sequence.

In high fiber count cables, 6 or 12 fibers are generally grouped, and then the groups themselves are numbered. An individual fiber's number equals the number of the group times 6 or 12 plus the number of the fiber in the group. The group size (6 fibers or 12) depends on the cable design and the total fiber count.

Sometimes, in cables with fiber count that is not a multiple of 12, and more so with cables with over 24 fibers, there are both 6- and 12-fiber groups.

Tube	Blue	Orange	Green	Brown	Slate	White	Red	Black	Yellow	Violet	Rose	Aqua
	1	2	3	4	5	6	7	8	9	10	11	12
Blue	1	13	25	37	49	61	73	85	97	109	121	133
Orange	2	14	26	38	50	62	74	86	98	110	122	134
Green	3	15	27	39	51	63	75	87	99	111	123	135
Brown	4	16	28	40	52	64	76	88	100	112	124	136
Slate	5	17	29	41	53	65	77	89	101	113	125	137
White	6	18	30	42	54	66	78	90	102	114	126	138
Red	7	19	31	43	55	67	79	91	103	115	127	139
Black	8	20	32	44	56	68	80	92	104	116	128	140
Yellow	9	21	33	45	57	69	81	93	105	117	129	141
Violet	10	22	34	46	58	70	82	94	106	118	130	142
Rose	11	23	35	47	59	71	83	95	107	119	131	143
Aqua	12	24	36	48	60	72	84	96	108	120	132	144

SCTE Fiber Optic Reference Chart ©SCTE

## 8.20 IP Utilities

The table below contains some general Internet Protocol utilities you can use for network connectivity troubleshooting.

### IP Utilities Description

Utility	Description	How To
arp -a	View the arp cache. (MAC Address to IP cache)	start => run (run box) => type "cmd" => type "arp -a"
arp -d	Delete the arp cache. (MAC Address to IP cache)	start => run (run box) => type "cmd" => type "arp -d"
dxdiag	View Windows Version & Memory	start => run (run box) => type "dxdiag"
getmac (XP & >)	Get the MAC Address	start => run (run box) => type "cmd" => type "getmac"
ifconfig	View IP Configuration for Macintosh, Linux and Unix.	"MAC: applications => utilities => terminal => type "ifconfig"  Linux: terminal => type "ifconfig"
ipconfig	View IP Address in Brief	start => run (run box) => type "cmd" => type "ipconfig"
ipconfig /all	View all IP Configuration	start => run (run box) => type "cmd" => type "ipconfig /all"
ipconfig /flushdns	Clear DNS Cache	start => run (run box) => type "cmd" => type "ipconfig /flushdns"
ipconfig /release	Release DHCP Lease	start => run (run box) => type "cmd" => type "ipconfig /release"
ipconfig /renew	Renew DHCP Lease	start => run (run box) => type "cmd" => type "ipconfig /renew"
ipv6 install / uninstall	Enable or Disable IPv6 in XP	start => run (run box) => type "cmd" => type "ipv6 uninstall"
mmc	Create custom Microsoft Consoles	start => run (run box) => type "mmc"
msconfig (XP Only)	Control Startup Programs and Service	start => run (run box) => type "msconfig"
msinfo	All Microsoft Information.	start => run (run box) => type "msinfo"

## IP Utilities Description (cont'd)

Utility	Description	How To
nbtstat -A	View NetBIOS information of Remote Node.	start => run (run box) => type "cmd" => type "nbtstat -A"
nbtstat -c	View Microsoft NetBIOS Name Cache.	start => run (run box) => type "cmd" => type "nbtstat -c"
nbtstat -p tcp -s	View packet loss.	start => run (run box) => type "cmd" => type "nbtstat -p tcp -s"
nbtstat -R	Purge local NetBIOS cache.	start => run (run box) => type "cmd" => type "nbtstat -R"
net send x.x.x.x "message"	Send network messages	start => run (run box) => type "cmd" => type "net send 192.168.100.1 message"
net share	View the shares of a computer	start => run (run box) => type "cmd" => type "net share"
net view	View network computers in your workgroup.	start => run (run box) => type "cmd" => type "net view"
netsh int ipv6 show address	View IPv6 address lifetimes	start => run (run box) => type "cmd" => type "netsh int ipv6 show address"
netsh interface ipv6 show joins	View multicast assigned group for IPv6	start => run (run box) => type "cmd" => type "netsh interface ipv6 show joins"
netsh interface ipv6 show neighbors	View IPv6 neighbor information.	start => run (run box) => type "cmd" => type "netsh interface ipv6 show neighbors"
netstat -a	View port information	start => run (run box) => type "cmd" => type "netstat -a"
netstat -e	Ethernet Statistics	start => run (run box) => type "cmd" => type "netstat -e"
netstat -r	View routing table.	start => run (run box) => type "cmd" => type "netstat -r"
nslookup	DNS Query Tool	start => run (run box) => type "cmd" => type "nslookup"
pathping x.x.x.x	Connectivity Test with network routes	start => run (run box) => type "cmd" => type "pathping 192.168.100.1"
ping -6 fe80::1c7f:af a8:293b:f8cf	PING IPv6 address	start => run (run box) => type "cmd" => type "ping -6 fe80::1c7f:afa8:293b:f8cf"

## IP Utilities Description (cont'd)

Utility	Description	How To
ping -a x.x.x.x	Connectivity Test with Hostname Lookup	start => run (run box) => type "cmd" => type "ping -a 192.168.100.1"
ping -c 2 x.x.x.x	Ping a node twice on Macintosh and Unix.	start => run (run box) => type "cmd" => type "ping -c 2 192.168.100.1"
ping -n 3 x.x.x.x	Ping a node 3 times in Windows.	start => run (run box) => type "cmd" => type "ping -n 192.168.100.1"
ping -t x.x.x.x	Continuous Connectivity Test	start => run (run box) => type "cmd" => type "ping -t 192.168.100.1"
ping x.x.x.x	Connectivity Test	start => run (run box) => type "cmd" => type "ping 192.168.100.1"
route print	View routing table	start => run (run box) => type "cmd" => type "route print"
tracert	Discover network routes and display hop count on a Macintosh or Linux machine.	"MAC: applications => utilities => terminal => type "tracert"  Linux: terminal => type "tracert"
tracert	Discover network routes and display hop count on a Windows machine.	start => run => type "cmd" => type "tracert 192.168.100.1"
winver	View Windows Version and Installed Service Packs	start => run (run box) => type "winver"

## 8.21 T568(RJ-45)

Below is the T568 wiring standards using a RJ-45 conductor data cable. The RJ-45 has room for eight conductors.

The two wiring standards are used to create a cross-over cable or a straight-through cable.

- Straight-through cable-use either T-568A or T-568B on both ends of the cable.
- Cross-over cable-wire a T-568A on one end and T-568B on the other end of the cable.

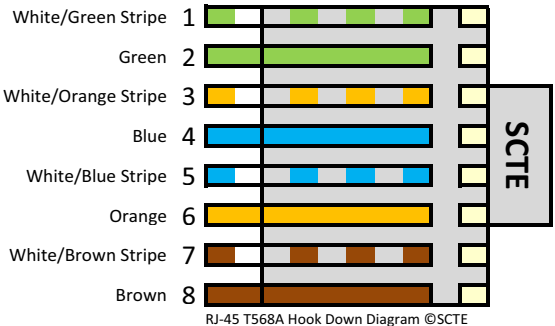
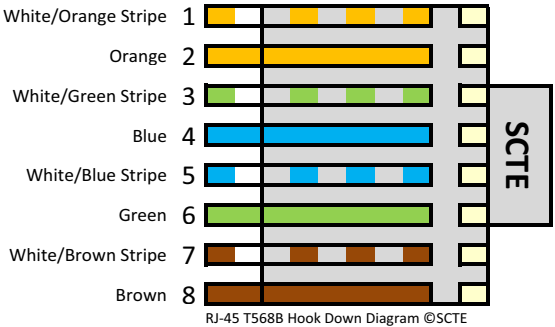

## 8.22 25 Pair Cable Color Codes (RJ-21)

Below is the industry standard color code in North America for telephone and data twisted pair cables.

### RING

	Blue	Orange	Green	Brown	Slate	
<b>T</b>	White	1	2	3	4	5
<b>I</b>	Red	6	7	8	9	20
<b>P</b>	Black	11	12	13	14	15
	Yellow	16	17	18	19	20
	Violet	21	22	23	24	25

Pair	Tip	Ring
1	white/blue	blue/white
2	white/orange	orange/white
3	white/green	green/white
4	white/brown	brown/white
5	white/slate	slate/white
6	red/blue	blue/red
7	red/orange	orange/red
8	red/green	green/red
9	red/brown	brown/red
10	red/slate	slate/red
11	black/blue	blue/black
12	black/orange	orange/black
13	black/green	green/black
14	black/brown	brown/black
15	black/slate	slate/black
16	yellow/blue	blue/yellow
17	yellow/orange	orange/yellow
18	yellow/green	green/yellow
19	yellow/brown	brown/yellow
20	yellow/slate	slate/yellow
21	violet/blue	blue/yellow
22	violet/orange	orange/yellow
23	violet/green	green/yellow
24	violet/brown	brown/yellow
25	violet/slate	slate/yellow

## 8.23 T568(RJ-11)

Below is the T568 wiring standard using a RJ-11 conductor data cable. The RJ-11 has room for six conductors.

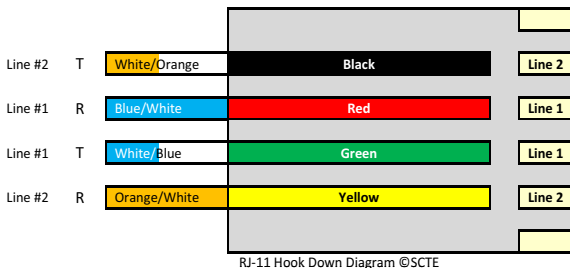

## 8.24 RJ-31x

Below is the wiring standard using a RJ-31X jack. The RJ-31X jack is designed for wiring an alarm panel and premise telephone on the same phone line while assuring that the alarm signals has priority over a voice call.

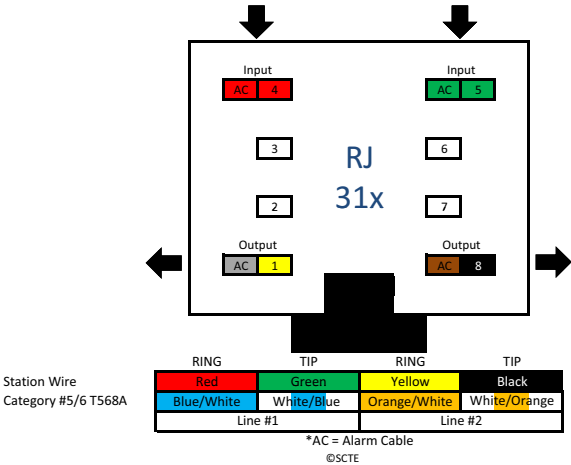

Station Wire  
Category #5/6 T568A



# Symbols and Acronyms

RF

Radio Frequency

HFC

DWDM

QAM

Quadrature Amplitude Modulation

## 9.1 Common CATV Symbols

Below are typical cable system map symbols. Most cable system operators use their own versions of these symbols, so use the symbols below as a general guideline.

### Signal Processing/Amplifier Locations



Headend



Primary Hub Location



Secondary Hub Location



Bridger Amplifier



Trunk Amplifier



Line Extender

### Coaxial Cables and Line Devices



0.412 Inch Cable



0.500 Inch Cable



0.750 Inch Cable



1.000 Inch Cable



Feeder Line Equalizer



Feeder Line Equalizer  
(alternate)



Splice



Splice  
(alternate)



Terminations

### Outlet TAPs



1 Outlet Tap



2 Outlet Tap



3 Outlet Tap



4 Outlet Tap



8 Outlet Tap

## Splitter Devices

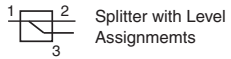
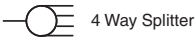
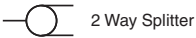

## Powering Devices

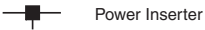

## Receiver and Transmitter

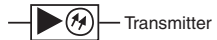

## Data Blocks

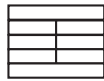
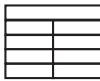
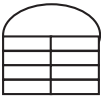

## Optical Splice Symbols

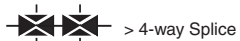
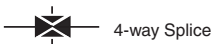
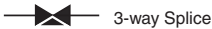
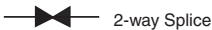

## Optical Devices



Optical Amplifier  
(EDFA)



Bi-directional  
(Mux/Demux)



Demultiplexer



RFoG Repeater



Multiplexer

## Miscellaneous Optical Symbols



Uni-Directional  
optical fiber cable

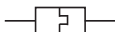

Optical Connector



Bi-Directional  
optical fiber cable



Optical Splitter



Optical Storage Loop  
(fiber slack location)

## Wireless Symbols



Omni-directional Wireless Hub



Omni-directional Customer  
Premises Equipment (CPE)



Directional Wireless Hub



Directional Customer  
Premises Equipment (CPE)

## 9.2 Common Industry Abbreviations and Acronyms

Term	Definition
AC	Alternating Current, Access Conditions, Access Customer, Area Code
ACD	Automatic Call Distributor
ADC, A/D	Analog to Digital Converter
ADPCM	Adaptive Differential Pulse Code Modulation
AFC	Automatic Frequency Control, Antenna for Communications
AFT	Automatic Fine Tuning
AGC	Automatic Gain Control
ALC	Automatic Level Control, ATM Link Controller
ALSC	Automatic Level and Slope Control
AM	Amplitude Modulation
AM-VSB	Amplitude Modulation - Vestigial Side Band
ANI	Automatic Number Identification
ANSI	American National Standards Institute
ARRL	American Radio Relay League
ARU	Audio Response Unit
ASC	Automatic Slope Control
ASCII	American Standard Code for Information Interchange
ASK	Amplitude Shift Keying
ATM	Asynchronous Transfer Mode
BASIC	Beginner's All-purpose Symbolic Instruction Code
BCT/E	Broadband Communications Technician/Engineer
BER	Bit Error Rate
BERT	Bit Error Rate Tester
BPF	Bandpass Filter
bps	Bits Per Second
BPSK	Binary Phase Shift Keying
BTSC	Broadcast Television Standards Committee
CAD	Computer Aided Design
CAN	Cable Area Network
CARS	Community Antenna Radio Service
CATV	Community Antenna Television, Cable Television
CB	Citizens Band Radio

<b>Term</b>	<b>Definition</b>
<b>CCITT</b>	Comite Consultatif Internationale de Telegraphique et Telephonique (see also ITU)
<b>CDMA</b>	Code Division Multiple Access
<b>CE</b>	Consumer Electronics
<b>CLEC</b>	Competitive Local Exchange Carrier
<b>CLI</b>	Cumulative Leakage Index
<b>CM</b>	Cable Modem, Computer Modem, Control Memory, Configuration Management
<b>CMTS</b>	Cable Modem Termination System, Computer Modem Termination System
<b>CNM</b>	Cable Network Manager
<b>CNR, C/N</b>	Carrier to Noise Ratio
<b>CO</b>	Central Office
<b>CODEC</b>	Coder/Decoder
<b>CoS</b>	Class of Service
<b>CPD</b>	Common Path Distortion
<b>CPE</b>	Customer Premises Equipment
<b>CPU</b>	Central Processing Unit
<b>CRC</b>	Cyclic Redundancy Check
<b>CRT</b>	Cathode Ray Tube
<b>CSO</b>	Composite Second Order
<b>CSR</b>	Customer Service Representative
<b>CTB</b>	Composite Triple Beat
<b>CW</b>	Continuous Wave, Carrier Wave
<b>DAC, D/A</b>	Digital to Analog Converter
<b>dB</b>	Decibel
<b>dBc</b>	Decibel relative to carrier
<b>dBm</b>	Decibel relative to milliwatt
<b>dBmV</b>	Decibel relative to millivolt
<b>DBS</b>	Digital Broadcasting Satellite, Digital Broadcast Service, Direct Broadcast Satellite
<b>DC</b>	Direct Current, Directional Coupler
<b>DCE</b>	Data Communications Equipment, Data Circuit-terminating Equipment
<b>DEMUX</b>	Demultiplexer
<b>DFB</b>	Distributed Feedback
<b>DMA</b>	Direct Memory Access

<b>Term</b>	<b>Definition</b>
<b>DOCSIS</b>	Data-Over-Cable Service Interface Specification
<b>DRAM</b>	Dynamic Random Access Memory, Digital Recorded Announcement Machine
<b>DS</b>	Digital Signal, Digital Service, Downstream
<b>DSL</b>	Digital Subscriber Line
<b>DTE</b>	Data Terminal Equipment
<b>DTMF</b>	Dial Tone Multi-frequency
<b>DVB</b>	Digital Video Broadcast
<b>DVR</b>	Digital Video Recorder
<b>DWDM</b>	Dense Wavelength Division Multiplexing
<b>EDFA</b>	Erbium Doped Fiber Amplifier
<b>EEPROM</b>	Electrically Erasable Programmable Read Only Memory
<b>EIA</b>	Electronic Industry Alliance, formerly known as Electronic Industries Association
<b>EISA</b>	Extended Industry Standard Architecture
<b>EMI</b>	Electromagnetic Interference
<b>EMS</b>	Element Management System
<b>EO</b>	End Office (exchange)
<b>EOL</b>	End of Line
<b>EPON</b>	Ethernet Passive Optical Network
<b>EPROM</b>	Erasable Programmable Read Only Memory
<b>EQAM</b>	Edge QAM
<b>ESD</b>	Electrostatic Discharge
<b>FCC</b>	Federal Communications Commission
<b>FDM</b>	Frequency Division Multiplex
<b>FDMA</b>	Frequency Division Multiple Access
<b>FEC</b>	Forward Error Correction
<b>FIFO</b>	First In, First Out
<b>FM</b>	Frequency Modulation
<b>FN</b>	Fiber Node
<b>FP</b>	Fabry-Perot
<b>FPGA</b>	Field Programmable Gate Array
<b>FSK</b>	Frequency Shift Keying
<b>FTP</b>	File Transfer Protocol
<b>FTTC</b>	Fiber to the Curb
<b>FTTF</b>	Fiber to the Feeder

<b>Term</b>	<b>Definition</b>
<b>FTTH</b>	Fiber to the Home
<b>GB</b>	Gigabyte (one billion bytes)
<b>GaAs</b>	Gallium Arsenide
<b>GaN</b>	Gallium Nitride
<b>Gbps</b>	Giga (1000 million) Bits Per Second
<b>GBps</b>	Giga (1000 million) Bytes Per Second
<b>GE-PON</b>	Gigabit Ethernet Passive Optical Network
<b>GPON</b>	Gigabit Passive Optical Network
<b>GHz</b>	Gigahertz
<b>GPS</b>	Global Positioning Satellite
<b>GUI</b>	Graphical User Interface
<b>HD</b>	High Definition
<b>HDMI</b>	High Definition Multimedia Interface
<b>HDT</b>	Host Digital Terminal
<b>HDTV</b>	High Definition Television
<b>HFC</b>	Hybrid Fiber/Coax
<b>HITS</b>	Headend In The Sky
<b>HPF</b>	High Pass Filter
<b>HRC</b>	Harmonically Related Carrier
<b>HTML</b>	Hypertext Markup Language
<b>HTTP</b>	Hypertext Transfer Protocol
<b>Hz</b>	Hertz
<b>I/O</b>	Input/Output
<b>IC</b>	Integrated Circuit, Inter-exchange Carrier
<b>IEEE</b>	Institute of Electrical and Electronics Engineers
<b>IF</b>	Intermediate Frequency
<b>IM</b>	Intermodulation
<b>I-Net</b>	Institutional Network
<b>IP</b>	Internet Protocol
<b>IPPV</b>	Impulse Pay Per View
<b>I/Q</b>	In-Phase Quadrature
<b>IR</b>	Infrared, Infrared Remote
<b>IRD</b>	Integrated Receiver/Decoder
<b>ISDN</b>	Integrated Services Digital Network
<b>ISO</b>	International Standards Organization



<b>Term</b>	<b>Definition</b>
<b>IT</b>	Information Technology
<b>ITU</b>	International Telecommunication Union
<b>kbps</b>	Kilobits Per Second
<b>kHz</b>	Kilohertz
<b>LAN</b>	Local Area Network
<b>LCD</b>	Liquid Crystal Display
<b>LEC</b>	Local Exchange Carrier, LAN Emulator Client
<b>LED</b>	Light Emitting Diode
<b>LFD</b>	Low Frequency Distortion
<b>LNA</b>	Low Noise Amplifier
<b>LNB, LNC</b>	Low Noise Block Converter
<b>LO</b>	Local Origination, Local Oscillator
<b>LOS</b>	Line of Sight, Loss of Optical Signal
<b>LPF</b>	Low Pass Filter
<b>LSb</b>	Least Significant Bit
<b>LSB</b>	Least Significant Byte
<b>MAC</b>	Media Access Control
<b>MATV</b>	Master Antenna TV System
<b>Mb</b>	Megabit (one million bits)
<b>MB</b>	Megabyte (one million bytes)
<b>Mbps</b>	Megabits Per Second
<b>MBps</b>	Megabytes Per Second
<b>MDU</b>	Multiple Dwelling Unit
<b>MER</b>	Modulation Error Ratio
<b>MF</b>	Multifrequency
<b>MHz</b>	Megahertz
<b>MIPS</b>	Million Instructions Per Second
<b>MMDS</b>	Multichannel Multipoint Distribution Service, Microwave Multipoint Distribution System
<b>MoCA</b>	Multimedia Over Coax Alliance
<b>MODEM</b>	Modulator/Demodulator
<b>MPEG</b>	Moving Pictures Expert Group
<b>MSb</b>	Most Significant Bit
<b>MSB</b>	Most Significant Byte
<b>MSO</b>	Multiple System Operator
<b>MTBF</b>	Mean Time Between Failure

<b>Term</b>	<b>Definition</b>
<b>MTS</b>	Modem Termination System, MPEG Transport Stream, Multichannel TV Sound
<b>MTTF</b>	Mean Time to Failure
<b>MTTR</b>	Mean Time to Repair
<b>MUX</b>	Multiplexer
<b>mW</b>	Milli-Watt
<b>NCTA</b>	National Cable and Telecommunication Association
<b>NCTI</b>	National Cable Television Institute
<b>NEC</b>	National Electrical Code
<b>NESC</b>	National Electrical Safety Code
<b>NIC</b>	Network Interface Card
<b>NML</b>	Network Management Layer
<b>NMS</b>	Network Management System
<b>NOC</b>	Network Operations Center
<b>NPR</b>	Noise Power Ratio
<b>NTSC</b>	National Television System Committee (US)
<b>NVOD</b>	Near Video On Demand
<b>OC</b>	Optical Carrier
<b>OMI</b>	Optical Modulation Index
<b>ONU</b>	Optical Network Unit
<b>OS</b>	Operating System
<b>OSD</b>	On-screen Display
<b>OTDR</b>	Optical Time Domain Reflectometer
<b>PAL</b>	Phase Alternation by Line (European 50 Hz analog TV standard)
<b>PAM</b>	Pulse Amplitude Modulation
<b>PC</b>	Personal Computer
<b>PCB</b>	Printed Circuit Board
<b>PCM</b>	Pulse Code Modulation
<b>PCMCIA</b>	Personal Computer Memory Card International Assn.
<b>PCS</b>	Personal Communications Services
<b>PIN</b>	Personal Identification Number
<b>PLL</b>	Phase Locked Loop
<b>POP</b>	Proof of Performance, Point of Presence
<b>POTS</b>	Plain Old Telephone Service
<b>PPV</b>	Pay Per View

<b>Term</b>	<b>Definition</b>
<b>PS</b>	Power Supply
<b>PSK</b>	Phase Shift Keying
<b>PSTN</b>	Public Switched Telephone Network
<b>PVC</b>	Polyvinyl Chloride
<b>QAM</b>	Quadrature Amplitude Modulation
<b>QOS</b>	Quality of Service
<b>QPSK</b>	Quadrature Phase Shift Keying
<b>RAID</b>	Redundant Array of Independent (Inexpensive) Disks
<b>RAM</b>	Random Access Memory
<b>RF</b>	Radio Frequency
<b>RFI</b>	Radio Frequency Interference
<b>RL</b>	Return Loss
<b>RMS</b>	Root Mean Square
<b>ROM</b>	Read Only Memory
<b>SAP</b>	Secondary Audio Program, Service Access Point, Service Advertisement Protocol
<b>S-CDMA</b>	Synchronous Code Division Multiple Access
<b>SCSI</b>	Small Computer System Interface
<b>SCTE</b>	Society of Cable Telecommunications Engineers
<b>SDH</b>	Synchronous Digital Hierarchy
<b>SECAM</b>	Système Électronique pour Couleur Avec Memoire (European TV)
<b>SMATV</b>	Satellite Master Antenna Televisions System
<b>SNMP</b>	Simple Network Management Protocol
<b>SNR, S/N</b>	Signal to Noise Ratio
<b>SONET</b>	Synchronous Optical Network
<b>SS7</b>	Signaling System 7, Switching System 7
<b>SSB</b>	Single Side Band, Star Star Bus
<b>TCP</b>	Transmission Control Protocol
<b>TCP/IP</b>	Transmission Control Protocol/Internet Protocol
<b>TDM</b>	Time Division Multiplex
<b>TDMA</b>	Time Division Multiple Access
<b>TDR</b>	Time Domain Reflectometer
<b>TL</b>	Transfer Linearization
<b>TVRO</b>	Television Receive Only Earth Station
<b>UHF</b>	Ultra-High Frequency

<b>Term</b>	<b>Definition</b>
<b>UI</b>	User Interface
<b>UPS</b>	Uninterruptable Power Supply, Universal Power Supply
<b>URL</b>	Uniform Resource Locator
<b>USB</b>	Universal Serial Bus
<b>US</b>	Upstream
<b>VBI</b>	Vertical Blanking Interval
<b>VCR</b>	Video Cassette Recorder
<b>VF</b>	Voice Frequency
<b>VHF</b>	Very High Frequency
<b>VHS</b>	Video Home System
<b>VIRS</b>	Vertical Interval Reference Signal
<b>VITS</b>	Vertical Interval Test Signal
<b>VOD</b>	Video On Demand
<b>VoIP</b>	Voice over Internet Protocol
<b>VOIP</b>	Voice On Internet Protocol
<b>VOP</b>	Velocity of Propagation
<b>VPN</b>	Virtual Private Network
<b>VSB</b>	Vestigial Sideband Modulation
<b>VT</b>	Virtual Tributary (SONET)
<b>WAN</b>	Wide Area Network
<b>WDM</b>	Wavelength Division Multiplexing
<b>Wi-Fi</b>	Wireless Fidelity (IEEE 802.11)
<b>WiMAX</b>	Worldwide Interoperability for Microwave Access (IEEE 802.16)
<b>WWW</b>	World Wide Web
<b>XMOD, XM</b>	Cross Modulation

# Data Transmission



## 10.1 Digital Transmission Standards

### North American Standards

Level	Bit Rate	Notes
DS-0	64 Kbps	Single digital voice circuit, including ISDN
DS-1	1.544 Mbps	24 DS-0s make up a DS-1 (also called T-1)
DS-1C	3.152 Mbps	2 DS-1s plus additional overhead
DS-2	6.312 Mbps	Composite of 4 DS-1s or 96 DS-0s
DS-3	44.736 Mbps	Composite of 28 DS-1s or 672 DS-0s
DS-4	274.176 Mbps	Equal to 6 DS-3s or 4096 DS-0s

### European Standards

Level	Bit Rate	Notes
E-0	64 Kbps	Equivalent to DS-0
E-1	2.048 Mbps	30 E-0s combined make up an E-1
E-2	8.448 Mbps	Equivalent to 4 DS-1s or 128 DS-0s
E-3	34.368 Mbps	Equivalent to 16 DS-1s or 512 DS-0s
E-4	139.264 Mbps	Equivalent to 64 DS-1s or 2048 DS-0s

### Levels

SONET	SDH	Bit Rate	Notes
OC-1		51.840 Mbps	The basic signal is STS-1/OC-1 (672 voice channels)
OC-3		155.520 Mbps	3 STS-1s (STS-3)
OC-3C	STM-1	155.250 Mbps	3 concatenated STS-1s (149 Mbps payload)
OC-12	STM-4	622.080 Mbps	12 STS-1s (STS-12)
OC-48	STM-16	2488.320 Mbps	48 STS-1s (STS-48)
OC-192	STM-64	9953.280 Mbps	192 STS-1s (STS-192)

SONET: Synchronous Optical Network

SDH: Synchronous Digital Hierarchy

ISDN: Integrated Service Digital Network

OC-\*: Optical Component—Level

STS-\*: Synchronous Transport Signal—Level

STM-\*: Synchronous Transfer Mode

## 10.2 Measuring Digital Carrier Signals

---



*Note*The following procedures assume basic knowledge of spectrum analyzer operation. Also refer to your spectrum analyzer's operating manual.

---

### 10.2.1 Digital Channel Power

1. In Spectrum Analyzer mode, adjust the display, including the center frequency, amplitude reference, and span, so that the signal occupies approximately 8 divisions horizontally and is within 1 vertical division of the reference line. The resolution bandwidth should be adjusted to 300 kHz or less. Use SMPL Detector mode (if applicable). Enable video filtering or video averaging, as appropriate, to smooth the display and aid in measuring.
2. Move the marker to the center of the displayed signal and record the level.
3. Correct the measurement for the difference between the analyzer resolution bandwidth and the signal's occupied bandwidth. Refer to the bandwidth correction factor table or calculate the factor:

$$\text{Bandwidth (BW) correction} = 10 \log_{10} (\text{signal BW} / \text{resolution BW})$$

4. The total channel power is the sum of the marker amplitude and the bandwidth correction. Note that some analyzers require an additional 2 dB correction when measuring noise-like signals.

Total channel power = marker amplitude + bandwidth correction + analyzer correction (analyzers that include a true RMS detection mode do not require the additional correction factor of 2 dB).

### 10.2.2 Digital Carrier/Noise Measurement

1. Measure the digital signal using the analyzer's normal marker.
2. Move the marker to an adjacent clear frequency and measure the noise. The indicated noise is the sum of analyzer noise and system noise.

3. Remove the analyzer input or preamp input, if used, terminate, and observe the reduction in noise. Refer to the graph on page ## and correct the measurement in step 2 for the true noise level.
4. The carrier/noise ratio is the difference between the signal measured in step 1 and the noise measured in step 2, plus the correction for analyzer noise as determined in step 3.



## 10.3 DOCSIS Transmission Downstream



*Note Assumes nominal analog video carrier level (peak envelope power) in a 6 MHz channel bandwidth. All conditions are present concurrently.*

Parameter	Value
Frequency range	Normal operating range is 50 MHz to 860 MHz; however, the values in this table apply only at frequencies $\geq 88$ MHz
RF channel spacing (design bandwidth)	6 MHz
Transit delay from headend to most distant customer	$\leq 0.8$ msec (typically much less)
Carrier-to-noise ratio in a 6 MHz band (analog video level)	$\geq 35$ dB
Carrier-to-interference ratio for total power (discrete and broadband ingress signals)	$\geq 35$ dB within the design bandwidth
Composite triple-beat distortion for analog modulated carriers	$\leq -50$ dBc within the design bandwidth
Composite second-order distortion for analog modulated carriers	$\leq -50$ dBc within the design bandwidth
Cross-modulation level	$\leq -40$ dBc within the design bandwidth
Amplitude ripple	0.5 dB within the design bandwidth
Group delay ripple in the spectrum occupied by the CMTS	75 ns within the design bandwidth
Micro-reflections bound for dominant echo	-10 dBc @ $\leq 0.5$ $\mu$ sec, -15 dBc @ $\leq 1.0$ $\mu$ sec, -20 dBc @ $\leq 1.5$ $\mu$ sec, -30 dBc @ $> 1.5$ $\mu$ sec
Carrier hum modulation	$\leq -2$ dBc (5%)
Burst noise	$\leq 25$ $\mu$ sec at a 10 Hz average rate
Seasonal and diurnal signal level variation	8 dB
Signal level slope, 50 MHz to 750 MHz	16 dB
Maximum analog video carrier level at the CM input, inclusive of signal level variation	17 dBmV

Parameter	Value
Frequency range	Normal operating range is 50 MHz to 860 MHz; however, the values in this table apply only at frequencies $\geq 88$ MHz
Lowest analog video carrier level at the CM input, inclusive of signal level variation	-5 dBmV

Transmission is from the headend combiner to the CM input at the customer location.

For measurements above the normal downstream operating frequency band (except hum), impairments are referenced to the highest-frequency NTSC carrier level.

For hum measurements above the normal downstream operating frequency band, a continuous-wave carrier is sent at the test frequency at the same level as the highest-frequency NTSC carrier.

This presumes that the digital carrier is operated at analog peak carrier level. When the digital carrier is operated below the analog peak carrier level, this C/N can be less.

Measurement methods defined in [NCTA] or [CableLabs2].

## 10.4 EuroDOCSIS Transmission Downstream



*Note This assumes nominal analog video carrier level (peak envelope power) in a 7 MHz to 8 MHz channel bandwidth. All conditions are present concurrently.*

Parameter	Value
Frequency range	Normal operation, 47 MHz to 862 MHz; data communication, 108 MHz to 862 MHz (use of frequencies between 108 MHz and 136 MHz may be forbidden by national regulation to prevent interference with air navigation frequencies)
RF channel spacing (design bandwidth)	7 MHz to 8 MHz (8 MHz channels used for data communication)
Transit delay from headend to most distant customer	≤ 0.8 msec (typically much less)
Carrier-to-noise ratio in an 8 MHz band (analog video level)	≥ 44 dB4
Carrier-to-interference ratio for total power (discrete and broadband ingress signals)	≥ 52 dB within the design bandwidth
Composite triple-beat distortion for analog modulated carriers	≤ -57 dBc within the design bandwidth6a
Composite second-order distortion for analog modulated carriers	≤ -57 dBc within the design bandwidth6a
Cross-modulation level	Under consideration
Amplitude ripple	2.5 dB in 8 MHz
Group delay ripple in the spectrum occupied by the CMTS	100 ns over frequency range 0.5 MHz to 4.43 MHz
Micro-reflections bound for dominant echo	-10 dBc @ ≤ 0.5 μsec, -15 dBc @ ≤ 1.0 μsec, -20 dBc @ ≤ 1.5 μsec, -30 dBc @ > 1.5 μsec
Carrier hum modulation	≤ -46 dBc (0.5%)
Burst noise	≤ 25 μsec at a 10 Hz average rate
Seasonal and diurnal signal level variation	8 dB
Signal level slope, 85 MHz to 862 MHz	12 dB max. in either direction

Parameter	Value
Frequency range	Normal operation, 47 MHz to 862 MHz; data communication, 108 MHz to 862 MHz (use of frequencies between 108 MHz and 136 MHz may be forbidden by national regulation to prevent interference with air navigation frequencies)
Maximum analog video carrier level at the system outlet, inclusive of signal level variation	77 dBmV6b
Lowest analog video carrier level at the system outlet, inclusive of signal level variation	60 dBmV6c
Transmission is from the headend combiner to the CM input at the customer location.	
For measurements above the normal downstream operating frequency band (except hum), impairments are referenced to the highest-frequency PAL/SECAM carrier level.	
For hum measurements above the normal downstream operating frequency band, a continuous-wave carrier is sent at the test frequency at the same level as the highest-frequency PAL/SECAM carrier.	
This presumes that the average digital carrier is operated at analog peak carrier level. When the digital carrier is operated below the analog peak carrier level, this C/N may be less.	
Measurement methods defined in [EN 50083-7].	
For SECAM systems, the following values apply:	
a) $\leq 52$ dBc within the design bandwidth	
b) 74 dBmV	
c) 57 dBmV	

## 10.5 DOCSIS Transmission Upstream



*Note All conditions are present concurrently.*

Parameter	Value
Frequency range	5 MHz to 42 MHz edge-to-edge
Transit delay from the most distant CM to the nearest CM or CMTS	$\leq 0.8$ msec (typically much less)
Carrier-to-noise ratio	$\geq 25$ dB
Carrier-to-ingress power (the sum of discrete and broadband ingress signals) ratio	$\geq 25$ dB <sup>2</sup>
Carrier-to-interference (the sum of noise, distortion, common-path distortion, and cross-modulation) ratio	$\geq 25$ dB
Carrier hum modulation	$\leq -23$ dBc (7%)
Burst noise	$\leq 10$ $\mu$ sec at a 1 kHz average rate for most cases <sup>3,4,5</sup>
Amplitude ripple	5 MHz to 42 MHz: 0.5 dB/MHz
Group delay ripple	5 MHz to 42 MHz: 200 ns/MHz
Micro-reflections—single echo	$-10$ dBc @ $\leq 0.5$ $\mu$ sec, $-20$ dBc @ $\leq 1.0$ $\mu$ sec, $-30$ dBc @ $> 1.0$ $\mu$ sec
Seasonal and diurnal signal level variation	$\leq 8$ dB min. to max.
Transmission is from the CM output at the customer location to the headend.	
Ingress avoidance or tolerance techniques MAY be used to ensure operation in the presence of time-varying discrete ingress signals that could be as high as 0 dBc [CableLabs <sup>1</sup> ].	
Amplitude and frequency characteristics sufficiently strong to partially or wholly mask the data carrier.	
CableLabs report containing distribution of return-path burst noise measurements and measurement method is forthcoming.	
Impulse noise levels are more prevalent at lower frequencies ( $< 15$ MHz).	

## 10.6 EuroDOCSIS Transmission Upstream



*Note All conditions are present concurrently.*

Parameter	Value
Frequency range	5 MHz to 65 MHz edge-to-edge
Transit delay from the most distant CM to the nearest CM or CMTS	$\leq 0.8$ msec (typically much less)
Carrier-to-noise ratio in active channel	$\geq 22$ dB
Carrier-to-ingress power (the sum of discrete and broadband ingress signals) ratio in active channel	$\geq 22$ dB
Carrier-to-interference (the sum of noise, distortion, common-path distortion, and cross-modulation) ratio in active channel	$\geq 22$ dB
Carrier hum modulation	$\leq -23$ dBc (7%)
Burst noise	$\leq 10$ $\mu$ sec at a 1 kHz average rate for most cases <sup>3,4</sup>
Amplitude ripple	5 MHz to 65 MHz: 2.5 dB/2 MHz
Group delay ripple	5 MHz to 65 MHz: 300 ns/2 MHz
Micro-reflections—single echo	-10 dBc @ $\leq 0.5$ $\mu$ sec, -20 dBc @ $\leq 1.0$ $\mu$ sec, -30 dBc @ $> 1.0$ $\mu$ sec
Seasonal and diurnal signal level variation	$\leq 12$ dB min. to max.
Transmission is from the CM output at the customer location to the headend. Ingress avoidance or tolerance techniques MAY be used to ensure operation in the presence of time-varying discrete ingress signals that could be as high as 0 dBc.	
Amplitude and frequency characteristics sufficiently strong to partially or wholly mask the data carrier.	
Impulse noise levels are more prevalent at lower frequencies ( $< 15$ MHz).	

## 10.7 Digital Signal Formats and Occupied Bandwidth<sup>1</sup>

Service	Modulation	Data Rate <sup>2</sup> (Mb/s)	Symbol Rate (Ms/ s)
Satellite 24 MHz BW	QPSK	39.02	19.51
Satellite 36 MHz BW	QPSK	58.53	29.27
OM1000 <sup>3</sup>	QPSK	2.048	1.024
IRT1000/2000 6 MHz BW <sup>3</sup>	64 QAM	30.34	5.057
IRT1000/2000 6 MHz BW <sup>3</sup>	256 QAM	42.88	5.361
IRT/MPS 8 MHz BW <sup>3</sup>	64 QAM	41.40	6.90
IRT/MPS 8 MHz BW <sup>3</sup>	256 QAM	55.20	6.90
Surfboard, SB7100	64 QAM	30.34	5.057
Music Choice	QPSK	0.694	0.347
OM2000	QPSK	2.005	1.024
SEM	64 QAM	26.97	5.056942
SEM	256 QAM	38.81	5.360537
SEM DVB	64 QAM	29.64	5.361
SEM DVB	256 QAM	39.52	5.361
APEX	64 QAM	26.97	5.056942
APEX	256 QAM	38.81	5.360537
APEX DVB	64 QAM	29.64	5.361
APEX DVB	256 QAM	39.52	5.361
1	Occupied bandwidth at -3 dB points = Symbol Rate		
2	Including overhead		
3	These products are obsolete.		

## 10.8 Bandwidth Correction Factors<sup>1</sup>

Channel Bandwidth	Analyzer Resolution Bandwidth			
	1 Hz <sup>2</sup>	30 kHz	100 kHz	300 kHz
192 kHz	52.83	8.06	2.83	0.00
200 kHz	53.01	8.24	3.01	0.00
347 kHz	55.40	10.63	5.40	0.63
1.000 MHz	60.00	15.23	10.00	5.23
1.200 MHz	60.79	16.02	10.79	6.02
2.000 MHz	63.01	18.24	13.01	8.24
3.000 MHz	64.77	20.00	14.77	10.00
4.000 MHz	66.02	21.25	16.02	11.25
4.200 MHz	66.23	21.46	16.23	11.46
5.057 MHz	67.04	22.27	17.04	12.27
5.361 MHz	67.29	22.52	17.29	12.52
6.040 MHz	67.81	23.04	17.81	13.04
6.900 MHz	68.39	23.62	18.39	13.62
6.952 MHz	68.42	23.65	18.42	13.65
19.510 MHz	72.90	28.13	22.90	18.13
29.265 MHz	74.66	29.89	24.66	19.89

1 This table provides the signal level correction factor for the difference in occupied bandwidth vs spectrum analyzer resolution bandwidth. Add the listed correction to the level indicated by the analyzer. It does not include the 2 dB correction required by some analyzers when measuring noise-like signals.

2 1 Hz resolution bandwidth is provided by the noise marker of the spectrum analyzer and does not require the 2 dB correction for noise-like signals.



## 10.9 RF Levels for 64 and 256 QAM Signals

---



*Note To minimize impact on plant performance digital channels must be set per specific product and system design standards. Refer to your system design and specific product's operating standards for further information, or contact your CommScope engineering sales representative. The minimum requirements are:*

---

Analog C/N	43 dB (per FCC Part 76)
CSO/CTB	51 dB (per FCC Part 76)
RF Ingress	-53 dBc < -10 dB at $\leq 0.5 \mu\text{sec}$ < -15 dB at $\leq 1.0 \mu\text{sec}$
Reflections	< -20 dB at $\leq 1.5 \mu\text{sec}$ < -30 dB at $\leq 4.5 \mu\text{sec}$ < -40 dB at $> 4.5 \mu\text{sec}$

---

## 10.10 Addressing Schemes and Protocols

### 10.10.1 Masks or Classless Subnetting



*Note* Follows a “slash” notation related to the number of “care” bits (1’s, not 0’s in binary form) in the subnet mask. For example, a subnet mask of 255.255.255.0 has 24 care bits (3 groups of 8 bits of 1). In classless notation this is referred to as a “/24” (slash-twenty-four).

Mask (Dotted Decimal)	Slash Notation	# Usable Hosts
255.0.0.0	/8	16777214
255.128.0.0	/9	8388606
255.192.0.0	/10	4194302
255.224.0.0	/11	2097150
255.240.0.0	/12	1048574
255.248.0.0	/13	524286
255.252.0.0	/14	262142
255.254.0.0	/15	131070
255.255.0.0	/16	65535
255.255.128.0	/17	32766
255.255.192.0	/18	16382
255.255.224.0	/19	8190
255.255.240.0	/20	4094
255.255.248.0	/21	2046
255.255.252.0	/22	1022
255.255.254.0	/23	510
255.255.255.0	/24	254
255.255.255.128	/25	126
255.255.255.192	/26	62
255.255.255.224	/27	30
255.255.255.240	/28	14
255.255.255.248	/29	6
255.255.255.252	/30	2
255.255.255.255*	/32	1

\* One host; not applicable for a physical subnet with multiple hosts

### 10.10.2 IP Address Classes

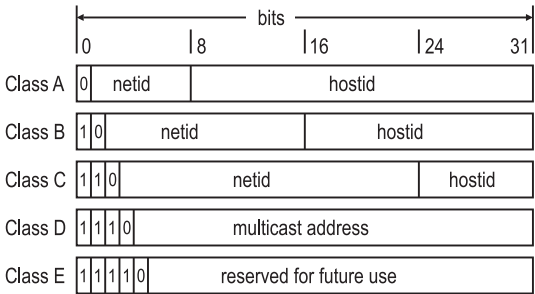

### 10.10.3 TCP Segment Format

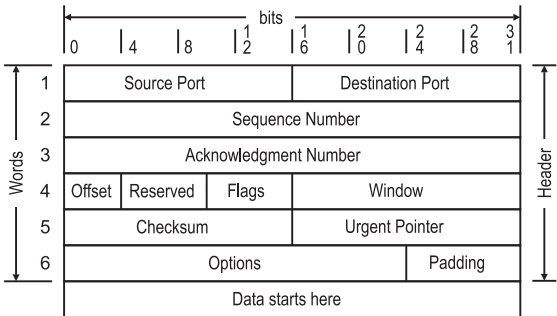

### 10.10.4 IP Datagram Format

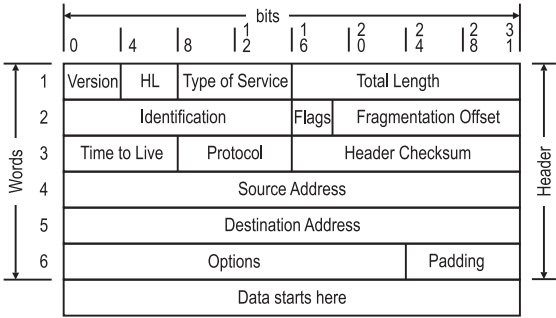

### 10.10.5 UDP Message Format

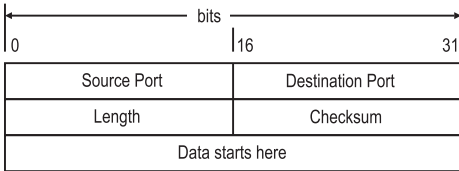

## 10.11 Constellation Diagrams

### 10.11.1 QPSK Constellation

Bits		Carrier Phase
0	0	225°
0	1	135°
1	0	315°
1	1	45°

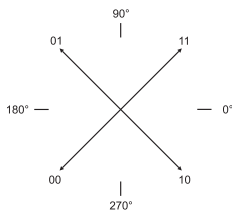

### 10.11.2 8PSK Constellation

Bits			Carrier Phase
0	0	0	202.5°
0	0	1	157.5°
0	1	0	337.5°
0	1	1	22.5°
1	0	0	247.5°
1	0	1	112.5°
1	1	0	292.5°
1	1	1	67.5°

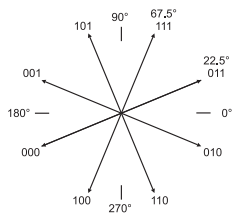

### 10.11.3 16 QAM Constellation

	Bits				Carrier	
					Phase	Amplitude
0	0	0	0	0	225°	0.268
0	0	0	1	1	135°	0.268
0	0	1	0	0	315°	0.268
0	0	1	1	1	45°	0.268
0	1	0	0	0	255°	0.732
0	1	0	1	1	105°	0.732
0	1	1	0	0	285°	0.732
0	1	1	1	1	75°	0.732
1	0	0	0	0	195°	0.732
1	0	0	1	1	165°	0.732
1	0	1	0	0	345°	0.732
1	0	1	1	1	15°	0.732
1	1	0	0	0	225°	1.0
1	1	0	1	1	135°	1.0
1	1	1	0	0	315°	1.0
1	1	1	1	1	45°	1.0

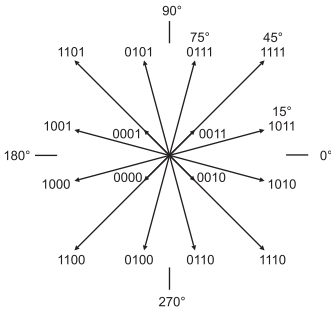

## 10.12 802.11a Channels

Channel	Frequency (Mhz)	Category	Max Power Level	Usage
36	5180	U-NII Low Band	40 mW	Indoor
40	5200	U-NII Low Band	40 mW	Indoor
44	5220	U-NII Low Band	40 mW	Indoor
48	5240	U-NII Low Band	40 mW	Indoor
52	5260	U-NII Medium Band	200 mW	Indoor
56	5280	U-NII Medium Band	200 mW	Indoor
60	5300	U-NII Medium Band	200 mW	Indoor
64	5320	U-NII Medium Band	200 mW	Indoor
149	5745	U-NII High Band	800 mW	Outdoor

## 10.13 802.11b/g Channels

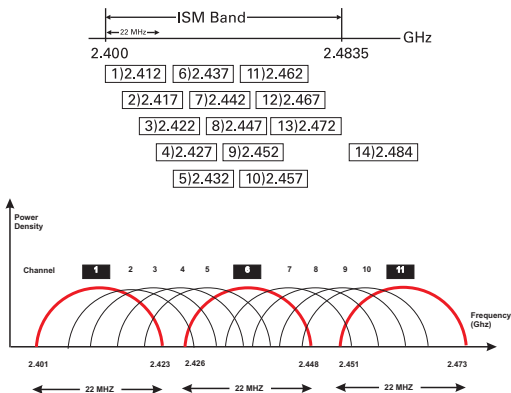

# 10.14 Linear Tilt Worksheet

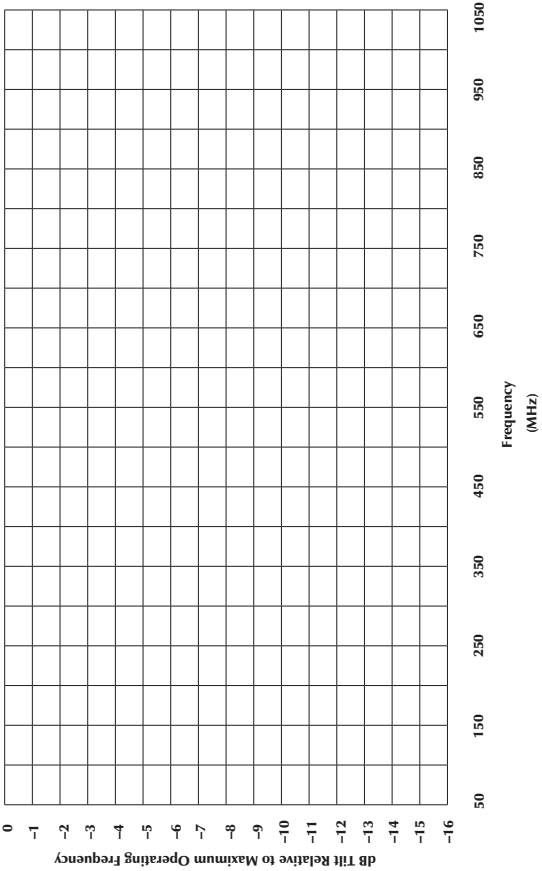



## 10.15 Digitizing an Analog Signal

An analog signal is a continuously varying signal, like a sine wave. This signal varies over time, and has an infinite number of points during its cycle. The magnitude of the signal at any given point in time is called its amplitude, which varies smoothly in time.

In a broadband network, the baseband signal to be transmitted—typically in frequency or amplitude—in either direction away from the center or reference. Changing the frequency is referred to as Frequency Modulation (FM), and changing the amplitude is referred to as Amplitude Modulation (AM). When the altered analog signal reaches its destination, the receiver compares the signal to the reference and derives the desired signal information from the comparison.

A digital signal in its simplest form is information coded into binary bits, or 1s and 0s. To transmit an analog signal digitally, the digital signal must be sampled, quantized, and encoded.

### 10.15.1 Sampling and Quantizing

Sampling is when the amplitude of a signal is determined at fixed points in time. The maximum frequency of the analog signal determines the sampling rate. The sampling rate must always be at least two times the frequency that is being digitized—this is referred to as the Nyquist Sampling Theorem. Sampled analog amplitudes are then quantized.

Quantizing is the process of recording each sample as a number corresponding to the amplitude of the signal at that time.

Sampling and quantizing determine how well the analog signal is represented digitally. Information in the analog signal is permanently lost during these processes, but increasing the sampling rate can minimize this loss. The accuracy of the digitizing process is determined by two factors:

- frequency of the sampling
- number of binary bits used to express the amplitudes.

The digitizing process and how the reconstruction of the analog signal is affected by sampling rate is illustrated in the *Low vs. High Sampling Rates* table on the following page.

## 10.15.2 Encoding

Quantized samples are encoded into binary data or bits that can be stored or transmitted. The greater the number of bits used to represent the amplitudes of the analog signal, the more precisely the digital representation of the analog signal can be reconstructed into the original signal. The number of values required to adequately quantize an analog waveform dictates how many bits are required to encode the signal.

## 10.15.3 Decoding

At the receive end, the bits are interpreted and used to reconstruct the analog signal.

### Low vs. High Sampling Rates

---

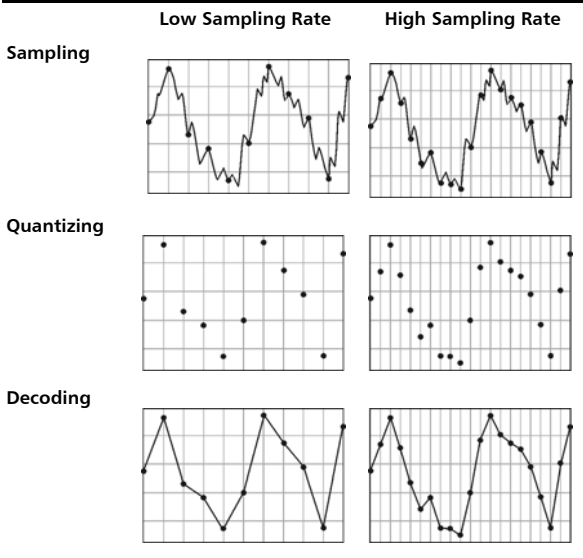

## 10.16 QAM Transmission Basics

**Quadrature Amplitude Modulation** is a technique for transmitting digital data as an analog signal. This is accomplished by using a carrier wave split into two carriers of identical frequency, shifted  $90^\circ$  apart, each modulated to one of two or more possible discrete amplitude levels. Each combination of amplitude levels on the two carriers translates to a binary bit pattern.

**I and Q components** are two halves of a digital data bit pattern transmitted simultaneously, as voltage levels of two identical frequency carriers phase shifted  $90^\circ$  apart. The **I** (incidence or in-phase) component modulates (is transmitted on) the carrier in phase with the clock (unshifted). The **Q** (quadrature) component modulates the carrier phase-shifted  $90^\circ$  from the clock. See the *QPSK Constellation Diagram Showing I/Q Vector* figure.

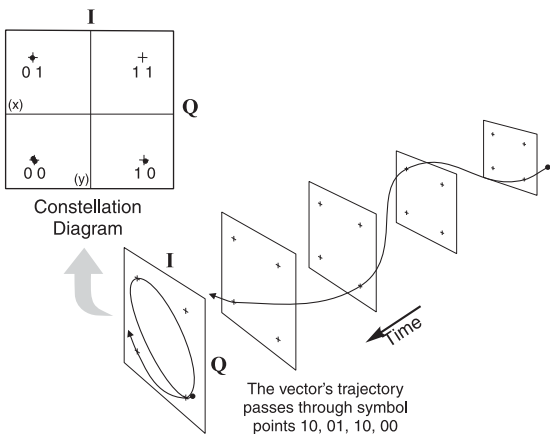

**QPSK Constellation Diagram Showing I/Q Vector**

**QPSK** (Quadrature Phase Shift Keying) is the simplest form of QAM (also known as, 4-QAM). QPSK uses two carriers with identical frequency, phase shifted 90° apart, and two possible amplitude levels. One amplitude level represents a 0, the other a 1. See *QPSK Constellation Diagram Showing I/Q Vector* figure.

### Bandwidth as Related to Bits per Symbol and Bit Rate

Modulation Format	Bits per Symbol	Bit Rate	Bandwidth (Symbol Rate)	Total Bandwidth (Including Guardbands)
QPSK	2	256kbps	128kHz	200kHz
QPSK	2	2Mbps	1 MHz	1.25MHz
QPSK	2	10Mbps	5 MHz	6MHz
8-VSB (US)	3	15Mbps	5 MHz	6MHz
16-VSB (US)	4	20Mbps	5 MHz	6MHz
16-QAM	4	20Mbps	5 MHz	6MHz
32-QAM	5	25Mbps	5 MHz	6MHz
64-QAM	6	30.342Mbps	5.057 MHz	6MHz
256-QAM	8	42.884Mbps	5.361 MHz	6MHz

**Constellation Diagram** is a map, or rectangular array, on which the received amplitude level of the **I** and **Q** QAM signal components are displayed as data points on an **I** x **Q** rectangular coordinate system. **I** components determine the horizontal position, and **Q** components determine the vertical position, of each data point. See the *Normal 64-QAM Constellation Diagram* figure. The constellation diagram is the matrix formed by horizontal and vertical lines (whether shown or imagined) between the possible **I** and **Q** component values. The digital value of each received data point is determined by which cell it falls into in the matrix. An error occurs if a data point falls outside its cell.

A 16-QAM diagram is a four-by-four array matrix with each of 16 cells representing one of the 16 possible binary combinations. The vertical and horizontal position of each dot corresponds to the **I** and **Q** amplitude levels of the signal transmitted in one cycle. See the *Normal 64-QAM Constellation Diagram* figure for a 64-QAM constellation diagram.

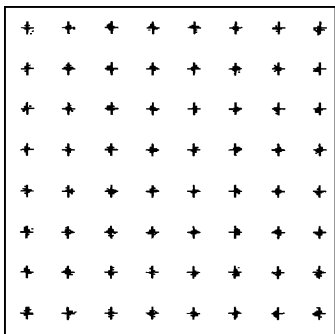

**Normal 64-QAM Constellation Diagram**

### 10.17 QAM Constellation Diagram Analysis

The patterns of dots in the constellation diagram cells can give some clues to transmission issues. Following is a list of common patterns and their typical diagnosis.

**Poor CNR**—picture will be perfect but slight further degradation will bring total failure. Fuzzy circular pattern in each cell will occupy most of the cell.

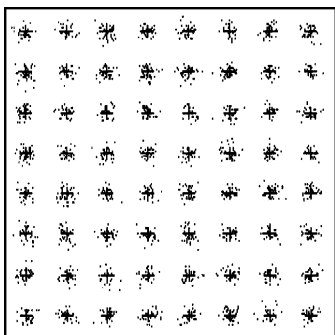

**Ingress or spurs**—caused by coherent noise; will cause circular patterns in each cell.

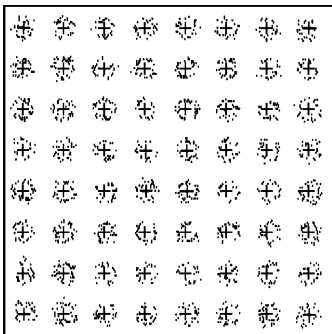

**Phase-shift**—caused by residual FM, normally a headend problem. Circular effect where points in each cell are stretched out perpendicular to a radius line, in proportion to the distance from the center of the diagram, giving an overall appearance of circles around the center of the diagram.

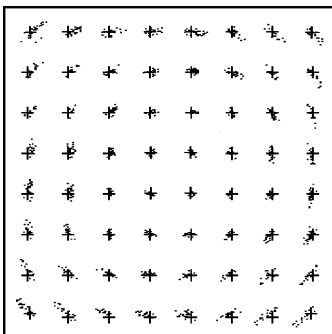

**Gain compression**—caused by IF and RF amplifiers and filters, up/down converters, or IF equalizers. Points pushed toward the I and Q axes in proportion to the distance from the center gives the outer boundary of the point pattern a rounded shape.

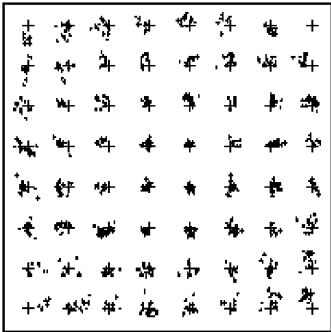

**I Q imbalance**—caused by problems with baseband amplifiers, filters, or the digital modulator, normally a headend problem. Overall pattern will appear taller than wide, or vice versa.

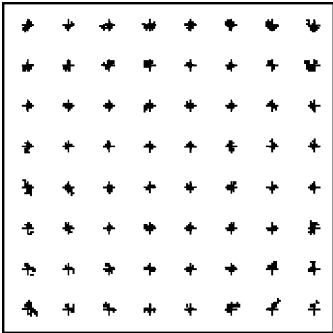

**Carrier leakage** (constellation offset)—caused by imbalance in the modulator's mixer or undesirable DC in the transmission system. Entire constellation is offset in one direction.

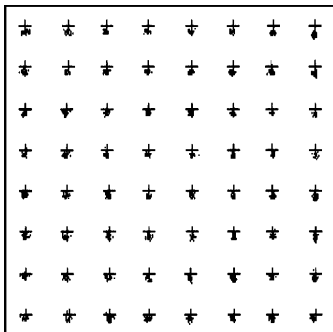



## Group Delay Variation (GDV) and Micro-Reflections

GDV occurs when the propagation delay through the RF device or channel varies with frequency, and with inadequate equalization, this causes signal distortion. In cable networks, GDV is often found at plant band edges and also at cutoff regions of diplex filters in nodes and amplifiers. Group delay ripple is a quasi-periodic variation in group delay vs. frequency due to micro-reflections from impedance mismatches caused by unterminated (or improperly terminated) lines and poorly designed CPE or plant amplifiers. Given a limited equalization capability, the higher the symbol rate, the more sensitive a QAM signal is to GDV. Group delay variation shows up in a QAM constellation diagram as rectangular or diamond shaped constellation points.

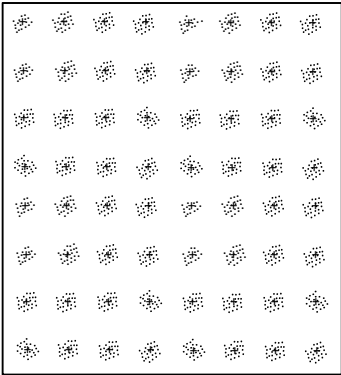

### 10.17.1 Transmission Speed vs. Noise

The benefit from higher QAM numbers is increased data transmission, since more data bits can be carried in each data cycle. At the same time, however, more data bits per cycle require more amplitude levels spaced closer together, making discrimination of the proper amplitude level more critical and subject to noise. Therefore, higher QAM numbers require correspondingly higher CNR performance to maintain a given allowable Bit Error Rate/Ratio (BER). See the *CNR in Relation to BER* figure.

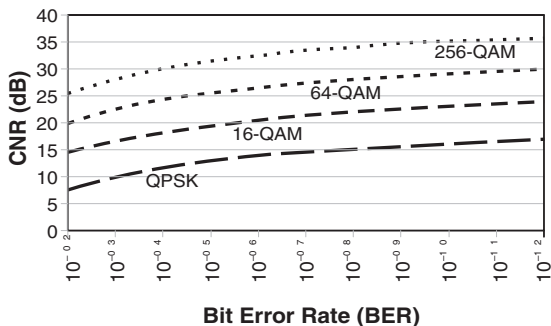

CNR in Relation to BER

### 10.18 BER, FEC, MER

**BER** (Bit Error Rate/Ratio) is the ratio of bits with errors to the total bits transmitted. Specifically, BER is the number of bit errors divided by the total number of transmitted bits. This can be expressed in dB, but is usually in a  $10^{-x}$  format. For example,  $10^{-9}$  represents 1 bit received in error out of 1 billion transmitted bits.

**NPR** (Noise Power Ratio) is a measurement technique used to determine the signal-to-noise performance of an analog device that has been loaded with multiple QAM or QPSK signals. Since QAM and QPSK signals have a frequency spectrum similar to Gaussian noise, the NPR test is accomplished by replacing the signals with an equivalent band of white noise. Toward the middle of the band, a “notch” of noise (typically 4MHz) is omitted.

When the band of noise is placed through a device, the depth of the notch will be limited by several factors. At low drive levels, the notch depth will be limited by system noise products such as Shot noise or Thermal noise. As the drive level is increased, the notch depth will increase 1 dB for every 1 dB of additional drive level until the device begins to enter compression. When the device enters compression, the notch will begin to fill with “noise-like” distortion products. Once compression is reached, the depth of the notch will typically decrease 5 dB for every 1 dB of additional drive level. NPR is occasionally referred to as the “Noise-in-the-Notch” test.

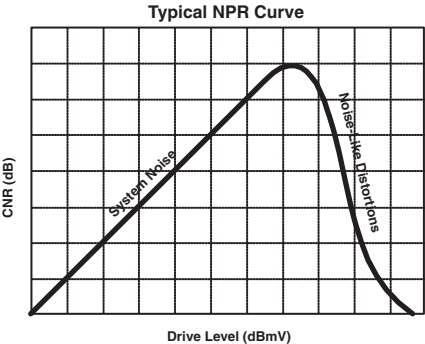

**FEC** (Forward Error Correction) is a programmed technique for identifying and correcting bit errors that occur in digital transmission. It is complex and processor intense, but necessary to prevent bit errors—which cannot be completely eliminated—from resulting in erroneous data or degraded picture quality.

**MER** (Modulation Error Ratio) is a measure of the deviation between the received value of the modulation (amplitude and/or phase) from the transmitted value in a digital transmission. It is a figure of merit for modulation quality, such as CNR is for analog TV. MER and CNR are both measured in dB and represent the signal power relative to noise or more generally interference power, so higher values of both indicate a better signal. However, MER includes the effects of all impairments to the digital signal,

including: thermal and phase noise; ingress, impulse, and burst noise; linear distortions such as micro-reflections, tilt, ripple, and GDV; nonlinear distortions such as CTB, CSO, CPD, X-mod and clipping; and even equalization performance and less than optimal modulation profiles.

$$\text{MER(dB)} = 10\log\left(\frac{\text{Average Symbol Power}}{\text{Average Error Power}}\right)$$

The effect of MER can be seen on a constellation diagram (see the *MER Representation* figure) by the tightness of the dot pattern within each cell. As MER increases to the point where dots on the constellation diagram fall on or over cell boundaries, BER will begin to increase rapidly. When the BER overcomes the FEC's capacity to correct the bit errors, transmission failure occurs suddenly. Almost to the point of failure, the data/picture quality can be excellent, giving no clue to the proximity of failure. This is known as the "cliff effect," where everything is fine, no matter how close to the edge, until you go over. The additional complication with digital transmission is, if you are just looking at the picture, you don't know where the edge is.

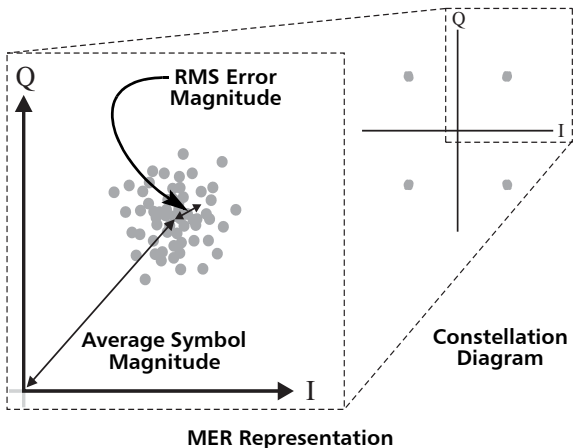

## 10.19 DOCSIS

DOCSIS, or Data Over Cable Service Interface Specifications, was developed out of the need for standards resulting from the personal computing explosion of the 1980s. As the awareness of the Internet increased, the demand for high-speed, high-quality data service also increased. With its inherent two-way signal capability, cable evolved into a hybrid digital and analog transmission system to accommodate the increasing demand for applications such as telephony and advanced video services. In 1995, a consortium of MSOs (Multiple System Operator) and cable manufacturers assembled to develop standards to create an open market for cable modems, ultimately enabling end-users to purchase the products of their choice. Today, DOCSIS is the dominant U.S. standard.

DOCSIS defines communications and operations support interface standards for cable modems and associated equipment involved in high-speed data distribution over broadband networks.

To qualify for DOCSIS certification, cable modems must meet the requirements defined in the technical specifications. (For detailed specifications, go to [www.cablelabs.com](http://www.cablelabs.com).)

DOCSIS 1.0 supports the following specifications:

- Radio Frequency (RF) Interface 1.0
- Operations Support System Interface (OSSI) 1.0
- Baseline Privacy Interface Specification (BPI)
- Cable Modem Termination System (CMTS)—Network
- Cable Modem to CPE Interface (CMCI)
- Acceptance Test Plan 1.0
- Cable Modem Telephony Return Interface

DOCSIS 1.1 supports the following specifications:

- DOCSIS 1.1 RFI Acceptance Test Plan
- Radio Frequency (RF) Interface 1.1
- Operations Support System Interface (OSSI) 1.1
- Baseline Privacy Plus Interface (BPI+)
- Cable Modem Termination System (CMTS)—Network

- Cable Modem to CPE (CMCI)
- DOCSIS 1.1 CMCI Acceptance Test Plan

DOCSIS 2.0 supports the following specifications:

- DOCSIS 2.0 RFI Acceptance Test Plan
- Radio Frequency (RF) Interface 2.0
- Operations System Support Interface (OSSI) 2.0
- Baseline Privacy Plus Interface (BPI+)
- Cable Modem Termination System (CMTS)—Network Side Interface
- Cable Modem to CPE (CMCI)
- Operations System Support Acceptance Test Plan
- Conformance Checklist/PICS Proforma

DOCSIS 3.0 supports the following specifications:

- Security Specification (CM-SP-SECv3.0-I13-100611)
- Cable Modem to Customer Premise Equipment Interface Specification (CM-SP-CMCIv3.0-I01-080320)
- Physical Layer Specification (CM-SP-PHYv3.0-I08-090121)
- MAC and Upper Layer Protocols Interface Specification (CM-SP-MULPIv3.0-I13-100611)
- Operations Support System Interface Specification (CM-SP-OSSlv3.0-I12-100611)

### 10.19.1 DOCSIS Reference Data

The following information is drawn from the Cablelabs DOCSIS 3.0 PHY Specification CM-SP-PHYv3.0-I08-090121 and from the DRFI specification CM-SP-DRFI-I10-100611.

#### **DOCSIS Downstream (DS) Center Frequency Range**

The cable modem (CM) **MUST** be able to tune from 91 to 867 MHz  $\pm$  30 kHz, while the CM **MAY** optionally tune from 57 to 999 MHz  $\pm$  30 KHz. Channel spacing is nominally 6 MHz.

Downstream symbol rates are 5.056941 Msym/sec (64-QAM) or 5.360537 Msym/sec (256-QAM).

The downstream also supports variable interleaving, which provides increasing immunity against burst noise at the cost of increasing latency (delay) in the downstream data. For broadcast/narrowcast digital video, this latency is generally acceptable and thus high levels of interleaving can be used, while for data transmissions, especially voice, video conferencing or video games, such high levels of latency can significantly degrade the user experience. Latencies as low as 0.15 ms and as high as 4.0 ms are possible using the interleaver taps (I) and interleaver increment (J) parameters. CMTS and EQAM manufacturers will typically recommend specific values of I and J to use depending on the type of service being transported over the downstream.

### **DOCSIS upstream**

DOCSIS upstream frequency range is either 5-42 MHz or 5-85 MHz, edge to edge. Upstream modulation is either via time division multiple access (TDMA) or Synchronous Code Domain Multiple Access (S-CDMA). S-CDMA was added in the DOCSIS 2.0 specification and provides much greater immunity against burst noise, which occurs to some degree below 30 MHz and to a high degree below 20 MHz on the upstream. TDMA is the original modulation scheme used on the upstream and is the still most commonly used. The modulation rates possible on the upstream range in octaves from 160 to 5120 ksym/s (TDMA), or from 1280 to 5120 kHz (S-CDMA chip rate).

There is much greater flexibility in specifying the upstream burst parameters, permitting a wide range of tradeoffs between capacity and robustness on the upstream. Upstream burst parameters that can be varied include Forward Error Correction (FEC) encoding, byte interleaving (TDMA only), Trellis Coded Modulation (TCM) encoding (S-CDMA only), S-CDMA framing parameters, and also the preamble length and guard time between upstream bursts.

CMTS manufacturers will typically recommend specific upstream burst profiles to use depending on the upstream center frequency, type of service being transported, and the amount of interference on the upstream. While not part of the DOCSIS specification, all CMTS vendors also provide variable ingress cancellation technology, which devotes a small portion of the

upstream capacity to characterizing the upstream ingress interference in isolation so that receiver signal processing can significantly reduce or eliminate the effect of the ingress interference. Both TDMA and S-CDMA modulation formats have ingress cancellation schemes associated with them, and CMTS vendors have several recommended profiles to use depending on the level and number of ingress signals on the upstream.

## 10.20 Common Industry Data Rates

Industry	Standard/Format	Data Rate (Mbps)
Video	Theoretical limit of 35 mm film	144000.000
Telecom	OC-192/STM-64	9953.280
Video	Typical pre-press workstation	2526.000
Telecom	OC-48/STM-16	2488.320
Video	Perceived quality of 35 mm film	2400.000
Telecom	HS2	1600.000
Video	Typical pre-press PC	1520.000
Video	Full bandwidth HDTV	1500.000
Telecom	OC-24	1244.000
Video	Compressed HDTV	995.000
Video	Typical engineering workstation	843.000
Telecom	HS1	800.000
Telecom	ATM/OC-12/STM-4	622.080
Video	High-end home PC	506.000
Datacom	"FireWire" (IEEE 1394)	400.000
Video	Mid-range home PC (SVGA)	310.000
Video	DVB-ASI	270.000
Video	CCIR601, including audio, etc.	270.000
Video	PAL 768 x 576	265.400
Video	Component NTSC, studio quality	251.000
Video	NTSC 640 x 480	220.900
Video	Low-end home PC (VGA)	198.000
Video	PAL video portion of CCIR601	177.000
Telecom	ATM/OC-3/STM-1	155.520
Video	SMPTE D-2/D-3	143.000
Video	NTSC, video portion of CCIR601	143.000
Telecom	E-4	140.000
Telecom	FDDI	100.000
Datacom	100-Base T Ethernet	100.000



<b>Industry</b>	<b>Standard/Format</b>	<b>Data Rate (Mbps)</b>
Telecom	OC-1	52.000
Video	BetaSP, MII	45.000
Video	Component NTSC, prod. quality	45.000
Telecom	DS-3/T-3	44.736
Telecom	E-3	34.000
Video	Composite NTSC, prod. quality	23.000
Video	Highly compressed HDTV	20.000
Video	ATSC	19.390
Audio	NV2000	18.400
Video	SVHS/Hi8 NTSC	12.000
Datacom	10Base-T Ethernet	10.00
Telecom	E-2	8.450
Video	MPEG-2 (8-45 Mbps)	8.000
Telecom	DS-2/T-2	6.300
Datacom	4x speed CD-ROM	4.600
Video	DBS (compressed)	4.600
Video	Mildly compressed NTSC	4.000
Audio	AES	3.070
Video	U-Matic NTSC tape playback	3.000
Datacom	2x speed CD-ROM, CD video	2.300
Telecom	E-1	2.048
Video	VHS NTSC tape playback	1.544
Telecom	DS-1/T-1	1.544
Video	MPEG-1 384 x 240	1.500
Audio	CD Audio	1.411
Datacom	CD-ROM	1.150
Datacom	Machine control	1.000
Video	Video-conferencing	0.768
Telecom	ISDN	0.144
Datacom	RS-232/RS-422	0.115
Telecom	DS-0/E-0/T-0	0.064
Telecom	Group III fax	0.014
Telecom	Group II fax	0.010
Audio	Telephone Audio	0.008
Datacom	SMPTE/EBU timecode	0.002



Fahrenheit  
Celsius

# Miscellaneous Data

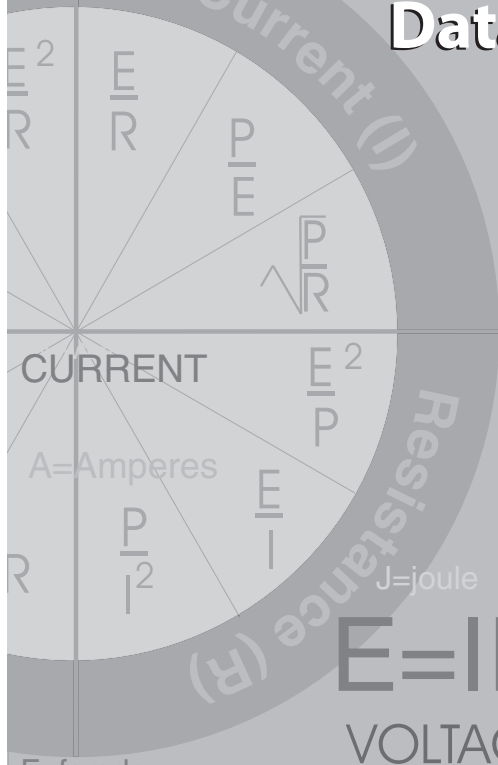

## 11.1 Scientific Prefix Symbols and Values

Prefix	Symbol	Value	Power of 10
femto	f	.000 000 000 000 001	$\times 10^{-15}$
pico*	p	.000 000 000 001	$\times 10^{-12}$
nano	n	.000 000 001	$\times 10^{-9}$
micro	$\mu$	.000 001	$\times 10^{-6}$
milli	m	.001	$\times 10^{-3}$
-	-	1.	$\times 10^0$
kilo	k	1 000.	$\times 10^{+3}$
mega	M	1 000 000.	$\times 10^{+6}$
giga	G	1 000 000 000.	$\times 10^{+9}$
tera	T	1 000 000 000 000.	$\times 10^{+12}$

\*  $\mu\mu$  is sometimes used in place of  $p$  for capacitor specifications

## 11.2 Unit Abbreviations

A = Amperes	hp = horsepower	m = meter
C = Coulomb	hr = hour	N = Newtons
cm = centimeter	in = inch	rad = radians
deg = degrees	J = joule	s = second
eV = electron volt	kg = kilogram	V = Volts
F = farads	l = liter	VAC = AC Volts
ft = feet	$\Omega$ = ohm	W = watts
gal = gallons	lb = pound	yd = yard

## 11.3 Unit Conversion Factors

To Convert	Into	Multiply By
ampere-hours	coulombs	3600.0 C/A-hr
centimeters	feet	$3.281 \times 10^{-2}$ ft/cm
centimeters	inches	0.394 in/cm
coulombs	farads	$1.036 \times 10^{-5}$ F/C
degrees	radians	$1.745 \times 10^{-2}$ rad/deg
dynes	joules/meter(N)	$1 \times 10^{-5}$ J/m-dynes
electron volts	joules	$1.60 \times 10^{-19}$ J/eV
farads/sec	amperes	96,500 A·s/F
feet	meters	0.3048 m/ft
feet	miles (statute)	$1.894 \times 10^{-4}$ miles/ft
foot-pound	Newton·meter	1.356 ft-lbs/N·m
gallons	liters	3.785 l/gal
inch-pound	Newton·meter	0.113 in-lbs/N·m
joules	electron volts	$6.25 \times 10^{18}$ eV/J
kilogram force·meter	Newton·meter	9.807 kg·m/N·m
kilograms	pounds	2.205 lbs/kg
liters	gallons	0.2642 gal/l
meters	feet	3.281 ft/m
meters	miles (statute)	$6.214 \times 10^{-4}$ miles/m
Newton·meter	foot-pound	0.7376 N·m/ft-lbs
Newton·meter	inch-pound	8.651 N·m/in-lbs
Newton·meter	kilogram force·meter	0.102 N·m/kg·m
newtons	dynes	$1 \times 10^5$ dynes/N
newtons	pounds	0.225 lb/n
pounds	kilograms	0.4536 kg/lbs
radians	degrees	57.30 deg/rad
yards	meters	0.9144 m/yd

### 11.3.1 Signal Level Conversions

0 dBm	48.75 dBmV (75 W)
0 dBW	78.75 dBmV (75 W)
0 dBmV	60 dBμV

## 11.4 Cable Math

Term/ Concept	Rule or Description	Example
<b>Exponent of zero</b>	Any number raised to the exponent zero is equal to 1.	$6^0 = 1$ ; $77^0 = 1$
<b>Exponent of one</b>	Any number raised to the exponent one is equal to itself.	$6^1 = 6$ ; $77^1 = 77$
<b>Multiplying exponents with the same base</b>	Add the exponents.	$6^3 \times 6^2 = 6^5$
<b>Dividing exponents with the same base</b>	Subtract the exponents.	$6^5 \div 6^3 = 6^2$
<b>Positive powers of 10</b>	The exponent and the number of zeros are always the same. The exponent and the number of places the decimal moves to the right of 1 are always the same.	$10^1 = 10.0$ $10^4 = 1,000.0$
<b>Negative powers of 10</b>	The absolute value of the exponent and the number of places the decimal moves to the left of 1 are always the same.	$10^{-1} = 0.1$ $10^{-4} = 0.0001$
<b>Scientific notation of numbers</b>	The base number: <ul style="list-style-type: none"> <li>■ Is written with only one digit to the left of the decimal place (1 through 10).</li> <li>■ Is multiplied by 10 raised to a particular power.</li> </ul> The exponent: <ul style="list-style-type: none"> <li>■ Is positive if the decimal was originally moved to the left.</li> <li>■ Is negative if the decimal was originally moved to the right.</li> </ul>	$5.976 \times 10^2$  $732,000 = 7.32 \times 10^5$  $0.000345 = 3.45 \times 10^{-4}$

Term/ Concept	Rule or Description	Example
Logarithms	<ul style="list-style-type: none"> <li>■ For all numbers below 10, the logarithm is a decimal number less than 1.</li> </ul>	Log 3 = 0.477
	<ul style="list-style-type: none"> <li>■ For numbers between 10 and 100, the logarithm is a fraction of a number between 1 and 2.</li> </ul>	Log 15 = 1.1761
	<ul style="list-style-type: none"> <li>■ For numbers between 100 and 1000, the logarithm is a fraction of a number between 2 and 3.</li> </ul>	Log 400 = 2.602
	<ul style="list-style-type: none"> <li>■ For numbers between 1,000 and 10,000, the logarithm is a fraction of a number between 3 and 4.</li> </ul>	Log 7,950 = 3.90036
Power Ratio	$dB = 10 \log[P_2/P_1]$ where: $P_2$ = output power, $P_1$ = input power	$dB = 10\log[2/1]$ $dB = 10\log(2)$ $dB = 10 * 0.301$
	<ul style="list-style-type: none"> <li>■ Divide the output power (P2) by the input power (P1).</li> </ul>	dB = 3.01
	<ul style="list-style-type: none"> <li>■ Take the log of that number.</li> </ul>	
	<ul style="list-style-type: none"> <li>■ Multiply the result by 10 to show the change measured in decibels.</li> </ul>	
Voltage Ratio	$dB = 20\log[E_2/E_1]$ where: $E_2$ = output voltage, $E_1$ = input voltage	$dB = 20\log[2/1]$ $dB = 20\log(2)$ $dB = 20 * 0.301$
	<ul style="list-style-type: none"> <li>■ Divide the output voltage (E2) by the input voltage (E1).</li> </ul>	dB = 6.02
	<ul style="list-style-type: none"> <li>■ Take the log of that number.</li> </ul>	
	<ul style="list-style-type: none"> <li>■ Multiply the result by 20 to show the change measured in decibels.</li> </ul>	
dBmV Values against Voltage Ratios	$dBmV = 20\log[\text{voltage}(mV)/1 \text{ mV}]$ where: dBmV referenced across 75 ohms	$dBmV = 20\log(10 \text{ mV}/1 \text{ mV})$ $dBmV = 20\log 10$ $dBmV = 20 * (1)$ $dBmV = 20$

## 11.5 Ohm's Law / Joule's Law Pie Chart

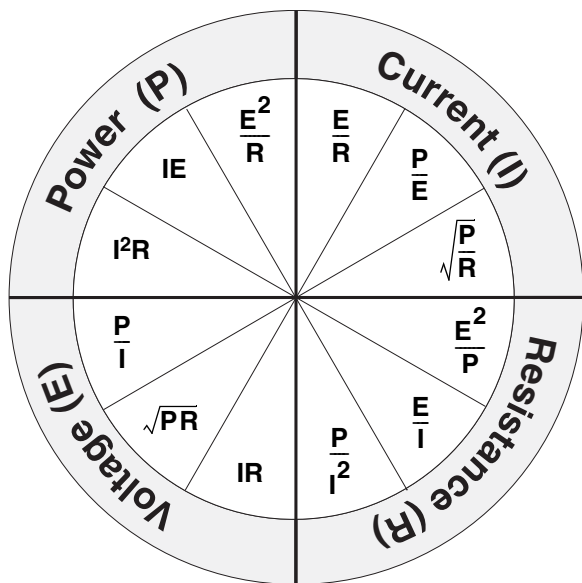

**I** = Current (Amps)

**E** = Voltage (Volts)

**R** = Resistance (Ohms)

**P** = Power (Watts)

**Ohm's Law**

$$E = I R$$

**Joule's Law**

$$P = E I$$



**Note:** In electrical engineering, voltage is sometimes indicated by an *E*. Also, the standard convention is to indicate time-invariant or fixed current and voltage quantities with uppercase letters (**I**, **E**) and time-dependent current and voltage quantities with lowercase letters (**i**, **e**).



## 11.6 Beat Table

The following table lists the greatest number of beats per TV channel for standard U.S. frequency assignments. Channel designations are EIA assignments.

Passband (MHz)	Number of Chs	Triple		Second Order		On Chs 5 and 6
		Beats	Channel	Beats	Channel	
<b>54-300</b>	35	334	11	8	36	20
<b>54-330</b>	40	461	23	10	41	25
<b>54-402</b>	52	842	28	16	53	37
<b>54-450</b>	60	1156	32	20	61	45
<b>54-504</b>	69	1567	37	25	70	54
<b>54-552</b>	77	1983	41	29	78	62
<b>54-654</b>	94	3026	49	37	100	79
<b>54-750</b>	110	4206	57	45	116	95
<b>54-864</b>	129	5867	75	55	138	114
<b>156-450</b>	42	840	37	11	61	N/A
<b>156-552</b>	66	1552	45	20	78	N/A
<b>222-450</b>	38	495	42	N/A	N/A	N/A
<b>222-552</b>	55	1067	51	9	78	N/A

# 11.7 Signal-to-Interference Limits for Non-Coherent NTSC Carriers

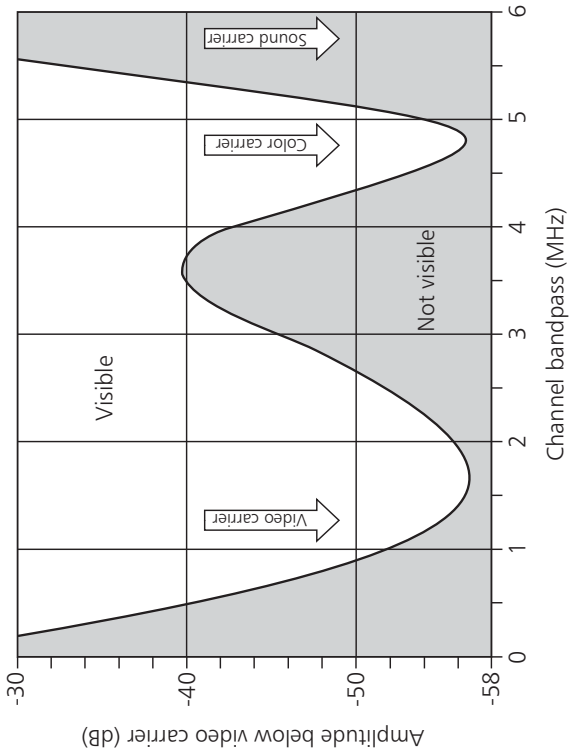

## 11.8 75 Ohm T- and Pi-Attenuators

Resistor values for 75 Ohm T- and Pi-attenuators with loss from 0.5 to 20dB are given in the following table.

Loss (dB)	Resistor Value ( $\Omega$ )			
	T-Attenuator		Pi-Attenuator	
	a	b	c	d
0.5	2.16	1302.16	2606.49	4.32
1.0	4.31	650.00	1304.32	8.65
1.5	6.46	432.14	870.75	13.02
2.0	8.60	322.86	654.32	17.42
2.5	10.72	257.01	524.75	21.89
3.0	12.82	212.89	438.60	26.42
4.0	16.97	157.24	331.46	35.77
5.0	21.01	123.36	267.73	45.60
6.0	24.92	100.40	225.71	56.03
7.0	28.69	83.70	196.09	67.20
8.0	32.29	70.96	174.21	79.27
9.0	35.72	60.89	157.49	92.38
10.0	38.96	52.70	144.37	106.73
11.0	42.02	45.92	133.87	122.49
12.0	44.89	40.22	125.32	139.87
13.0	47.56	35.35	118.27	159.11
14.0	50.05	31.17	112.39	180.46
15.0	52.35	27.55	107.44	204.21
16.0	54.48	24.39	103.25	230.67
17.0	56.43	21.62	99.67	260.18
18.0	58.23	19.19	96.60	293.15
19.0	59.87	17.04	93.96	330.01
20.0	61.36	15.15	91.67	371.25

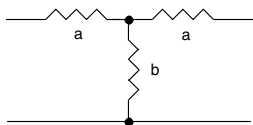

**T-Attenuator**

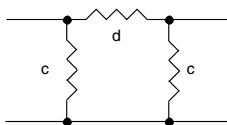

**Pi-Attenuator**

Construct the attenuator as shown in the appropriate diagram above, using the resistor values from the table column headed by the letter corresponding to the resistor.

Resistor values may also be determined, for attenuators with 75 ohm or any impedance, from the following equations.

$$a = z \left\{ \frac{10^{\frac{n}{20}} - 1}{10^{\frac{n}{20}} + 1} \right\}$$

$$b = 2z \left\{ \frac{10^{\frac{n}{20}}}{10^{\frac{n}{10}} - 1} \right\}$$

$$c = z \left\{ \frac{10^{\frac{n}{20}} + 1}{10^{\frac{n}{20}} - 1} \right\}$$

$$d = \frac{z}{2} \left\{ \frac{10^{\frac{n}{10}} - 1}{10^{\frac{n}{20}}} \right\}$$

where:

**n** = Loss in dB

**z** = Impedance in Ohms

**Example:** Find the resistor values for a 75Ω T-attenuator with a 2dB loss.

$$a = 75 \left\{ \frac{10^{\frac{2}{20}} - 1}{10^{\frac{2}{20}} + 1} \right\} = 75 \left( \frac{1.259 - 1}{1.259 + 1} \right) = 75(0.1146) = 8.60 \Omega$$

$$b = 2(75) \left\{ \frac{10^{\frac{2}{20}}}{10^{\frac{2}{10}} - 1} \right\} = 150 \left( \frac{1.259}{1.585 - 1} \right) = 150(2.152) = 322.86 \Omega$$

## 11.9 Wavelength and Antennas

### 11.9.1 Vertical Antenna Separation

Antennas for differing frequencies mounted on a common mast should be separated by at least the length of the longest element of the largest antenna.

### 11.9.2 Wavelength (in inches)

$$\lambda = \frac{11811}{f(\text{MHz})}$$

### 11.9.3 Quarter Wave Whip Antenna (length in inches)

$$\frac{\lambda}{4} = \frac{2775}{f(\text{MHz})}$$

### 11.9.4 Distance to Horizon (over a smooth Earth)

$$\text{Optical } D = 1.23\sqrt{H}$$

$$\text{Radio } D = 1.41\sqrt{H}$$

D: Distance in miles

H: Observation height in feet

### 11.9.5 Velocity of Propagation

In free space RF propagates at approximately 186,000 mi/sec or 982 ft/ $\mu$ sec. To find the velocity in cable, use the multiplier given for the cable.

## 11.10 Signal Leaking Limits

(per FCC Rules, 76.605)

Frequencies	Leakage Limit ( $\mu\text{V}/\text{m}$ )	Distance (m)
< 54 MHz and > 216 MHz	15	30
From 54 MHz to 216 MHz	20	3



*Note For operation in the frequency bands 108 MHz to 137 MHz and 225 MHz to 400 MHz, refer to section 76.610 of the FCC Rules.*

## 11.11 Field Intensity vs Dipole Level

Channel	Frequency (MHz)	20 $\mu\text{V}/\text{m}$	50 $\mu\text{V}/\text{m}$
2	55.25	-35.3 dBmV	-27.3 dBmV
4	67.25	-37.0 dBmV	-29.0 dBmV
6	83.25	-38.8 dBmV	-30.9 dBmV
FM	90.00	-39.5 dBmV	-31.5 dBmV
FM	95.00	-40.0 dBmV	-32.0 dBmV
FM	100.00	-40.4 dBmV	-32.5 dBmV
FM	105.00	-40.8 dBmV	-32.9 dBmV
60	109.25	-41.2 dBmV	-33.2 dBmV
14	121.25	-42.1 dBmV	-34.1 dBmV
16	133.25	-42.9 dBmV	-35.0 dBmV
19	151.25	-44.0 dBmV	-36.1 dBmV
7	175.25	-45.3 dBmV	-37.3 dBmV
10	193.25	-46.1 dBmV	-38.2 dBmV
13	211.25	-46.9 dBmV	-39.0 dBmV

Calculated data for the table above were derived from the following equation:

$$V(\text{dBmV}) = 20 \log_{10} \left( \frac{E(\mu\text{V}/\text{m})}{0.021f(\text{MHz})} / 1000 \right)$$

Correct as appropriate for antenna gain, preamplifier gain, cable loss, and distance between cable and antenna greater than three meters.

To convert from dBmV to  $\mu\text{V}/\text{m}$ :

$$E(\mu\text{V}/\text{m}) = 21f(\text{MHz})10^{\frac{1\text{dBmV}}{20}}$$

## 11.12 Directional Couplers

Directional couplers are three-port devices that are used in broadband systems to split an RF signal into unequal parts. The through port has minimal insertion loss, and the coupled port (down leg) has the larger insertion loss. The directional coupler has the unique ability to pass signals from the input to the coupled port and reject signals from the through port.

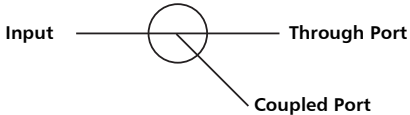

Physically, a directional coupler is a special RF broadband transformer wound on a two-hole ferrite core where the turns ratio determines the coupling value. The coupled value of a directional coupler is represented by the following equation.

$$C_{dB} = 10 \log \left( \frac{1}{N^2} \right)$$

Where:

$C_{dB}$  = the coupled value in dB

$N$  = the turns ratio

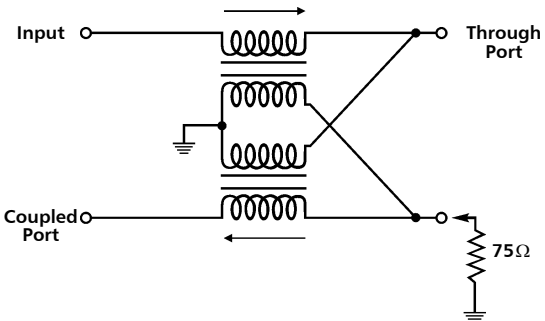

Directional Coupler Schematic

## 11.13 dBmV Conversion (for 75Ω systems)

dBmV	mV	dBμV	dBm	Volts RMS	CurrentRMS	Ave. Pwr
-60	0.001	0	-108.751	1.000μV	13.333nA	13.333fW
-59	0.0011	1	-107.751	1.122μV	14.960nA	16.786fW
-58	0.0013	2	-106.751	1.259μV	16.786nA	21.132fW
-57	0.0014	3	-105.751	1.413μV	18.834nA	26.603fW
-56	0.0016	4	-104.751	1.585μV	21.132nA	33.492fW
-55	0.0018	5	-103.751	1.778μV	23.710nA	42.164fW
-54	0.0020	6	-102.751	1.995μV	26.603nA	53.081fW
-53	0.0022	7	-101.751	2.239μV	29.850nA	66.825fW
-52	0.0025	8	-100.751	2.512μV	33.492nA	84.128fW
-51	0.0028	9	-99.751	2.818μV	37.578nA	105.910fW
-50	0.0032	10	-98.751	3.162μV	42.164nA	133.333fW
-49	0.0035	11	-97.751	3.548μV	47.308nA	167.857fW
-48	0.0040	12	-96.751	3.981μV	53.081nA	211.319fW
-47	0.0045	13	-95.751	4.467μV	59.558nA	266.035fW
-46	0.0050	14	-94.751	5.012μV	66.825nA	334.918fW
-45	0.0056	15	-93.751	5.623μV	74.979nA	421.637fW
-44	0.0063	16	-92.751	6.310μV	84.128nA	530.810fW
-43	0.0071	17	-91.751	7.079μV	94.393nA	668.250fW
-42	0.0079	18	-90.751	7.943μV	105.910nA	841.276fW
-41	0.0089	19	-89.751	8.913μV	118.833nA	1.059pW
-40	0.0100	20	-88.751	10.000μV	133.333nA	1.333pW
-39	0.0112	21	-87.751	11.220μV	149.602nA	1.679pW
-38	0.0126	22	-86.751	12.589μV	167.857nA	2.113pW
-37	0.0141	23	-85.751	14.125μV	188.338nA	2.660pW
-36	0.0158	24	-84.751	15.849μV	211.319nA	3.349pW
-35	0.0178	25	-83.751	17.783μV	237.104nA	4.216pW
-34	0.0200	26	-82.751	19.953μV	266.035nA	5.308pW
-33	0.0224	27	-81.751	22.387μV	298.496nA	6.682pW
-32	0.0251	28	-80.751	25.119μV	334.918nA	8.413pW
-31	0.0282	29	-79.751	28.184μV	375.784nA	10.591pW
-30	0.0316	30	-78.751	31.623μV	421.637nA	13.333pW
-29	0.0355	31	-77.751	35.481μV	473.085nA	16.786pW
-28	0.0398	32	-76.751	39.811μV	530.810nA	21.132pW
-27	0.0447	33	-75.751	44.668μV	595.578nA	26.603pW
-26	0.0501	34	-74.751	50.119μV	668.250nA	33.492pW
-25	0.0562	35	-73.751	56.234μV	749.788nA	42.164pW
-24	0.0631	36	-72.751	63.096μV	841.276nA	53.081pW
-23	0.0708	37	-71.751	70.795μV	943.928nA	66.825pW
-22	0.0794	38	-70.751	79.433μV	1.059μA	84.128pW
-21	0.0891	39	-69.751	89.125μV	1.188μA	105.910pW
-20	0.1000	40	-68.751	100.000μV	1.333μA	133.333pW



dBmV	mV	dBµV	dBm	Volts RMS	CurrentRMS	Ave. Pwr
-19	0.112	41	-67.751	112.202µV	1.496µA	167.857pW
-18	0.126	42	-66.751	125.893µV	1.679µA	211.319pW
-17	0.141	43	-65.751	141.254µV	1.883µA	266.035pW
-16	0.158	44	-64.751	158.489µV	2.113µA	334.918pW
-15	0.178	45	-63.751	177.828µV	2.371µA	421.637pW
-14	0.200	46	-62.751	199.526µV	2.660µA	530.810pW
-13	0.224	47	-61.751	223.872µV	2.985µA	668.250pW
-12	0.251	48	-60.751	251.189µV	3.349µA	841.276pW
-11	0.282	49	-59.751	281.838µV	3.758µA	1.059nW
-10	0.316	50	-58.751	316.228µV	4.216µA	1.333nW
-9	0.355	51	-57.751	354.813µV	4.731µA	1.679nW
-8	0.398	52	-56.751	398.107µV	5.308µA	2.113nW
-7	0.447	53	-55.751	446.684µV	5.956µA	2.660nW
-6	0.501	54	-54.751	501.187µV	6.682µA	3.349nW
-5	0.562	55	-53.751	562.341µV	7.498µA	4.216nW
-4	0.631	56	-52.751	630.957µV	8.413µA	5.308nW
-3	0.708	57	-51.751	707.946µV	9.439µA	6.682nW
-2	0.794	58	-50.751	794.328µV	10.591µA	8.413nW
-1	0.891	59	-49.751	891.251µV	11.883µA	10.591nW
0	1.000	60	-48.751	1.000mV	13.333µA	13.333nW
1	1.122	61	-47.751	1.122mV	14.960µA	16.786nW
2	1.259	62	-46.751	1.259mV	16.786µA	21.132nW
3	1.413	63	-45.751	1.413mV	18.834µA	26.603nW
4	1.585	64	-44.751	1.585mV	21.132µA	33.492nW
5	1.778	65	-43.751	1.778mV	23.710µA	42.164nW
6	1.995	66	-42.751	1.995mV	26.603µA	53.081nW
7	2.239	67	-41.751	2.239mV	29.850µA	66.825nW
8	2.512	68	-40.751	2.512mV	33.492µA	84.128nW
9	2.818	69	-39.751	2.818mV	37.578µA	105.910nW
10	3.162	70	-38.751	3.162mV	42.164µA	133.333nW
11	3.548	71	-37.751	3.548mV	47.308µA	167.857nW
12	3.981	72	-36.751	3.981mV	53.081µA	211.319nW
13	4.467	73	-35.751	4.467mV	59.558µA	266.035nW
14	5.012	74	-34.751	5.012mV	66.825µA	334.918nW
15	5.623	75	-33.751	5.623mV	74.979µA	421.637nW
16	6.310	76	-32.751	6.310mV	84.128µA	530.810nW
17	7.079	77	-31.751	7.079mV	94.393µA	668.250nW
18	7.943	78	-30.751	7.943mV	105.910µA	841.276nW
19	8.913	79	-29.751	8.913mV	118.833µA	1.059µW
20	10.00	80	-28.751	10.000mV	133.333µA	1.333µW
21	11.22	81	-27.751	11.220mV	149.602µA	1.679µW
22	12.59	82	-26.751	12.589mV	167.857µA	2.113µW

dBmV	mV	dB $\mu$ V	dBm	Volts RMS	Current <sub>RMS</sub>	Ave. Pwr
23	14.13	83	-25.751	14.125mV	188.338 $\mu$ A	2.660 $\mu$ W
24	15.85	84	-24.751	15.849mV	211.319 $\mu$ A	3.349 $\mu$ W
25	17.78	85	-23.751	17.783mV	237.104 $\mu$ A	4.216 $\mu$ W
26	19.95	86	-22.751	19.953mV	266.035 $\mu$ A	5.308 $\mu$ W
27	22.39	87	-21.751	22.387mV	298.496 $\mu$ A	6.682 $\mu$ W
28	25.12	88	-20.751	25.119mV	334.918 $\mu$ A	8.413 $\mu$ W
29	28.18	89	-19.751	28.184mV	375.784 $\mu$ A	10.591 $\mu$ W
30	31.62	90	-18.751	31.623mV	421.637 $\mu$ A	13.333 $\mu$ W
31	35.48	91	-17.751	35.481mV	473.085 $\mu$ A	16.786 $\mu$ W
32	39.81	92	-16.751	39.811mV	530.810 $\mu$ A	21.132 $\mu$ W
33	44.67	93	-15.751	44.668mV	595.578 $\mu$ A	26.603 $\mu$ W
34	50.12	94	-14.751	50.119mV	668.250 $\mu$ A	33.492 $\mu$ W
35	56.23	95	-13.751	56.234mV	749.788 $\mu$ A	42.164 $\mu$ W
36	63.10	96	-12.751	63.096mV	841.276 $\mu$ A	53.081 $\mu$ W
37	70.79	97	-11.751	70.795mV	943.928 $\mu$ A	66.825 $\mu$ W
38	79.43	98	-10.751	79.433mV	1.059mA	84.128 $\mu$ W
39	89.13	99	-9.751	89.125mV	1.188mA	105.910 $\mu$ W
40	100.00	100	-8.751	100.00mV	1.333mA	133.333 $\mu$ W
41	112.20	101	-7.751	112.202mV	1.496mA	167.857 $\mu$ W
42	125.89	102	-6.751	125.893mV	1.679mA	211.319 $\mu$ W
43	141.25	103	-5.751	141.254mV	1.883mA	266.035 $\mu$ W
44	158.49	104	-4.751	158.489mV	2.113mA	334.918 $\mu$ W
45	177.83	105	-3.751	177.828mV	2.371mA	421.637 $\mu$ W
46	199.53	106	-2.751	199.526mV	2.660mA	530.810 $\mu$ W
47	223.87	107	-1.751	223.872mV	2.985mA	668.250 $\mu$ W
48	251.19	108	-0.751	251.189mV	3.349mA	841.276 $\mu$ W
49	281.84	109	0.249	281.838mV	3.758mA	1.059mW
50	316.23	110	1.249	316.228mV	4.216mA	1.333mW
51	354.81	111	2.249	354.813mV	4.731mA	1.679mW
52	398.11	112	3.249	398.107mV	5.308mA	2.113mW
53	446.68	113	4.249	446.684mV	5.956mA	2.660mW
54	501.19	114	5.249	501.187mV	6.682mA	3.349mW
55	562.34	115	6.249	562.341mV	7.498mA	4.216mW
56	630.96	116	7.249	630.957mV	8.413mA	5.308mW
57	707.95	117	8.249	707.946mV	9.439mA	6.682mW
58	794.33	118	9.249	794.328mV	10.591mA	8.413mW
59	891.25	119	10.249	891.251mV	11.883mA	10.591mW
60	1000.00	120	11.249	1.000V	13.333mA	13.333mW
61	1122.02	121	12.249	1.122V	14.960mA	16.786mW

where: m = mill =  $10^{-3}$ ,  $\mu$  = micro =  $10^{-6}$ , n = nano =  $10^{-9}$ ,  
p = pico =  $10^{-12}$ , f = femto =  $10^{-15}$

## 11.14 Conversion Formulas

$$\text{Value in dBm} = 10 \log (\text{value in mW})$$

$$\text{Value in mW} = 10^{(\text{value in dBm}/10)}$$

$$\text{dBmV} = 20 \log (\text{mV}/1 \text{ mV})$$

$$\text{mV} = 10^{(\text{dBmV}/20)}$$

$$\text{dB}\mu\text{V} = 20 \log (\mu\text{V}/1 \mu\text{V})$$

$$\mu\text{V} = 10^{(\text{dB}\mu\text{V}/20)}$$

$$\text{dBm} = 10 \log (\text{mW}/1 \text{ mW})$$

$$\text{mW} = 10^{(\text{dBm}/10)}$$

$$\text{dBmV} = \text{dB}\mu\text{V} - 60$$

$$\text{dBmV} = \text{dBm} + 48.751$$

$$\text{dB}\mu\text{V} = \text{dBmV} + 60$$

$$\text{dB}\mu\text{V} = \text{dBm} + 108.751$$

$$\text{dBm} = \text{dBmV} - 48.751$$

$$\text{dBm} = \text{dB}\mu\text{V} - 108.751$$

$$P_{\text{avg}} = I_{\text{rms}} \cdot E_{\text{rms}}$$

$$P_{\text{avg}} = I_{\text{rms}} \cdot E_{\text{rms}} \cos\theta \quad (\text{For sinusoidal signals})$$

$$P = I^2 \cdot R$$

Where:

P = power in Watts

E = voltage in volts

I = current in amps

R = resistance in ohms

## 11.15 Celsius/Fahrenheit Conversion

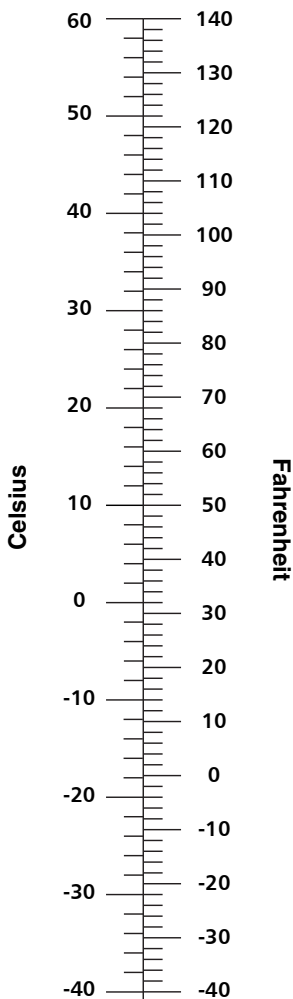

### Conversion Formulas

#### To Celsius

$$^{\circ}\text{C} = \frac{5}{9} (^{\circ}\text{F} - 32)$$

#### To Fahrenheit

$$^{\circ}\text{F} = \frac{9}{5} (^{\circ}\text{C}) + 32$$

### Conversion Shortcut

**To °C:** Subtract 32; divide by 2; add 10%.

Ex: 56°F to Celsius

$$56 - 32 = 24$$

$$24/2 = 12$$

plus 10%  $\cong$  13°C

**To °F:** Multiply by 2; subtract 10%; add 32.

Ex: 8°C to Fahrenheit

$$8 \times 2 = 16$$

$$\text{less } 10\% \cong 14$$

$$14 + 32 = 46^{\circ}\text{F}$$

## 11.16 Length Conversions

	millimeter	centimeter	meter	kilometer	inch	foot	yard	mile
1 millimeter	1	0.1	0.001	1 x 10 <sup>-6</sup>	0.03937	0.00328	0.00109	6.21 x 10 <sup>-7</sup>
1 centimeter	10	1	0.01	1 x 10 <sup>-5</sup>	0.3937	0.03281	0.01093	6.21 x 10 <sup>-6</sup>
1 meter	1,000	100	1	0.001	39.37007	3.28083	1.09361	0.00062
1 kilometer	1 x 10 <sup>6</sup>	1 x 10 <sup>5</sup>	1,000	1	39,370.07	3,280.84	1,093.61	0.62137
1 inch	25.4	2.54	0.0254	2.54 x 10 <sup>-5</sup>	1	0.0833	0.0277	1.57 x 10 <sup>-5</sup>
1 foot	304.8	30.48	0.3048	0.0003	12	1	0.333	0.000189
1 yard	914.399	91.4399	0.91439	0.00091	36	3	1	0.000568
1 mile	1.609 x 10 <sup>6</sup>	160,934.40	1,609.34	1.60934	63,360	5,280	1,760	1

## 11.17 Data Interface Connectors

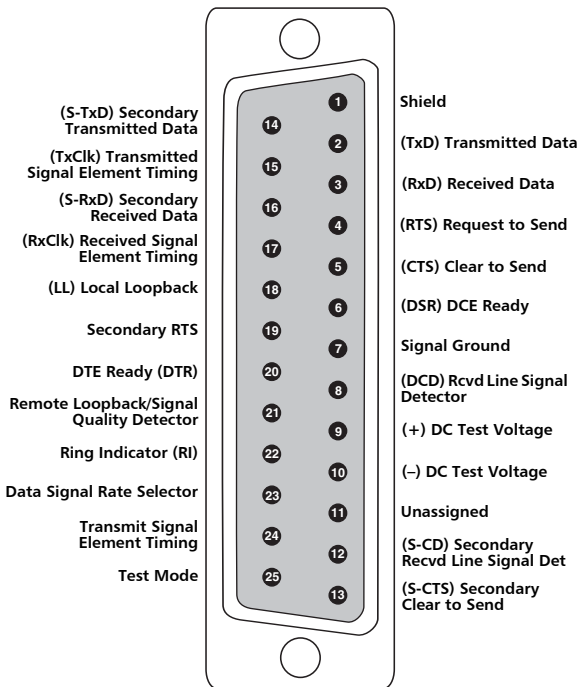

**EIA-232 DB25 Female Connector**

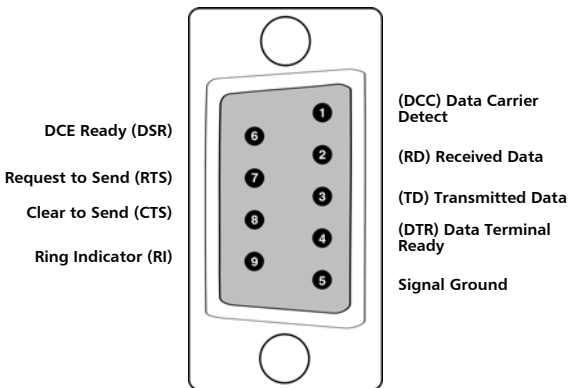

**EIA-232 DB9 Female Connector**







COMMSCOPE®

[www.commscope.com](http://www.commscope.com)

1-828-324-2200

---

SCTE • ISBE

[www.scte.org](http://www.scte.org)

800-542-5040